

PRODUCT CATALOGUE

Cable connecting systems
and Accessories
Low and Medium Voltage



We connect your energy
www.cellpack.com

Information

Our internal sales team or responsible field representatives will be happy to answer all your commercial and technical questions.

This product catalogue is only valid until BBC Cellpack replaces it with a new catalogue.

Contracts are concluded subject to our General Terms and Conditions.

The BBC Cellpack General Terms and Conditions (AGB) can be found on our website www.cellpack.com

BBC Cellpack assumes no responsibility for the topicality, correctness, completeness, or quality of the information in the catalogue. BBC Cellpack assumes no liability for deviations in the catalogue contents, transmission errors of documents, and errors in documents created for the catalogue, nor for unauthorised changes made by third parties to the information on the server.

All product characteristics, data and values contained in the catalogue – including figures and graphics – correspond to the status of the catalogue production and are presented to the best of our knowledge. They do not, however, represent a binding guarantee of properties. Such a guarantee is only issued if explicitly stated when a contract is concluded between BBC Cellpack and the customer and about our product standards. Users of these products must decide for themselves and at their own responsibility whether they are suitable for the intended use.

Liability claims against BBC Cellpack relating to material or non-material damage caused by the use or non-use of the catalogue information provided or by the use of incorrect or incomplete information shall generally be excluded, unless it can be proven that BBC Cellpack acted with intent or gross negligence.

All product information is therefore provided without any guarantees. It is also subject to errors or changes.

A new product catalogue created by BBC Cellpack completely replaces all previous older catalogue versions. BBC Cellpack expressly reserves the right to change, supplement or delete parts of the catalogue or the entire offer without prior notice or to cease publication temporarily or permanently.

LOW VOLTAGE	9
Heat shrink technology	11
Cast resin technology	71
Gel technology	113
MEDIUM VOLTAGE	129
Cable sets for unscreened polymeric cables	131
Cable sets for screened polymeric cables	139
Cable sets for mass-impregnated paper cables	183
Heat shrinkable components	195
CONNECTING TECHNOLOGY	201
Compression connectors	202
Compression cable lugs	204
Screw connectors	206
Screw cable lugs	207
Branch ring connectors	208
Miscellaneous	210
ELECTRICAL INSULATION AND MOUNTING TAPES	223
Electrical insulation and mounting tapes	225
Additional tapes	238
Miscellaneous	242
ACCESSORIES	243
Cable ties	244
Tools	247
Chemical products	253
Miscellaneous	268
INDEX	275
Index: of article numbers	276
Index: of article designations	281
Index: of product families	282

COMPANY PROFILE



Electrical Products

Being an SME company within the Behr Bircher Cellpack (BBC) Group in Villmergen/Switzerland, BBC Cellpack Electrical Products has successfully established itself in the global markets, in the fields of development, production and customer oriented sales of cable connecting systems and accessories for the low and medium voltage up to 42 kV.



We connect your energy

Power utilities, electrical wholesalers, specialist electrical trade or the industry – they all share one thing in common: regarding a high operational safety for the power supply services in the distribution network as their first priority. The system solutions and products developed by BBC Cellpack for complex, high-tech applications have significantly contributed to this.



Technology & Innovation

With our customer-oriented understanding of technologies and the distinctive culture of innovation, we have committed ourselves to concentrate, not only on the demands of our customers for technically innovative and thoroughly tested products, but also to ensure the safe and reliable functioning of our system solutions.



Quality & Service

BBC Cellpack has gained worldwide recognition for highest material and product quality with standards being continuously controlled in our high-performance laboratories and testing facilities in Germany. This high benchmark also applies to the availability and delivery service of our products. The quality standard "Swiss Quality – Made in Germany" is our commitment.

TECHNOLOGY AND PRODUCT PORTFOLIO

HEAT SHRINK TECHNOLOGY



Cable accessories with heat shrink components made of extruded plastic material (thermoplastic) offer a wide field of applications for all kind of cables, as well as conductor and cross section range in the low and medium voltage. They protect the cable connection against water and moisture penetration and thus against metal corrosion and guarantee for excellent electrical insulation values as well as mechanical protection. The hybrid joints and terminations, designed by BBC Cellpack especially for the medium voltage, combine components of silicone rubber and heat shrink products for safe and reliable operations.

The heat shrink product range includes straight-through, transition and pot end joints, terminations, wall ducts, repair sleeves and repair kits etc., heat shrink moulded parts as well as heat shrink tubes in various designs and types.

CAST RESIN TECHNOLOGY



BBC Cellpack cast resin joints offer an overall long-term protection in terms of insulation values and resistance for all kind of cable accessories and cross sections. This is guaranteed by high-grade, unfilled two-component PUR cast resins which are designed for various applications as well as by the shockproof plastic moulds available with or without integrated strain relief. After the hardening process, the cable joints are resistant to mechanical and electrical loads.

The scope of delivery for all cast resins straight-through and branch joints or universal connection and branch

boxes of BBC Cellpack includes a cast resin tailored to the pre-selected field of application. The cast resins are further available individually in two-chamber bags with separation bars, if requested. The mixing of the cast resin component and the hardener is effected directly before the filling into the mould which is designed with at least one filling opening.

TECHNOLOGY AND PRODUCT PORTFOLIO

GEL TECHNOLOGY



Our EASY-PROTECT gel-filled housings for easy, fast and safe moisture protection of WAGO COMPACT Splicing Connectors. This combination integrates the market leader's expertise in electrical interconnections with reliable gels from BBC Cellpack to deliver a unique system. The EASYCELL® gel joints offer easy, quick and therefore practical solutions for connecting and branching low voltage cables up to 1 kV. The impact-resistant polypropylene plastic shells are made of flame-retardant material and also allow the EASYCELL® gel joints to be used in demanding environments. Label-free, silicone-based gel sealing compound for

protecting electrical and electronic components in the low voltage range up to 1 kV are available in extremely user-friendly versions. They are transparent or translucent, largely individually portioned, easily removable, halogen-free, UV-resistant and flexible.

PLUG-IN & CONTRAX TECHNOLOGY



The compact, pluggable straight-through joint Compax with its particularly high level of pre-configuration, together with the innovative, pluggable connections Cellplux for outer-cone-systems, have been developed specifically for polymeric-insulated 1-core medium voltage cables. The integrated components system and robust construction also allow a fast and safe realization of cross-section range taking joint- or connector solutions.

The Contrax medium voltage terminations and straight-through joints provide the integration of the relevant core components within a one-piece insulator made of

silicone rubber resistant to high voltage. These expand and are easily installed by means of the patented slip-on accessory with the assembly only.

All the BBC Cellpack technologies guarantee for highest assembly and operational safety – not least by thorough quality controls and testing.

TECHNOLOGY AND PRODUCT PORTFOLIO

CONNECTING TECHNOLOGY



BBC Cellpack screw connectors and screw cable lugs are suitable for cross-section ranges, reliable termination and joints of both, copper and aluminium cables. Furthermore, the innovative shear-off head bolts are designed for the use of just one conventional tool. The integrated centering and further technical optimizations allow to eliminate common assembly errors already before the installation.

Compression connectors, compression cable lugs, branch clamps and wire connectors in various types round up the connector portfolio tailored to the

BBC Cellpack cable sets for a safe and permanent connection of copper or aluminium cables.

ELECTRICAL INSULATION & MOUNTING TAPES



Insulating, bundling, labeling, protecting, affixing, mounting, padding, sealing or repairing: Electrical insulation and mounting tapes for low and medium voltage have to meet most different requirements. Therefore, BBC Cellpack has aligned the individual functional profiles of its tapes to the various applications in an optimal way.

The high-quality Premio PVC electrical insulation tapes, available in all standard colors, are particularly flexible, stabilized against UV rays and packed separately in practical plastic boxes. Furthermore, the Premio family

provides PVC and PSE tapes for bundling and affixing, heat-resistant glass fibre cloth tapes as well as copper foil for discharge and screening.

Standard PVC insulation tapes, self-amalgamating tapes, cloth and sealing tapes as well as hot melt adhesives round up the assortment.

TECHNOLOGY AND PRODUCT PORTFOLIO

ACCESSORIES AND SPECIFIC PRODUCTS



Whether you need useful tools for connecting and branching of low and medium voltage cables, products for bundling, marking or feeding of cables and wires, or for insulation, sealing and cleaning – BBC Cellpack provides a field-tested range of accessories for various uses and applications.

The product portfolio ranges from heating systems to cable ties and markers and fastening elements, tools such as heat shrink torch kits, clamp tools and striping tools, up to special products such as cleaners (as cloth or spray), anti-corrosion and insulation sprays, cable







lubricants, putty/sealing compounds, cable centering aids and screen connecting kits for telecommunication cables.

LOW VOLTAGE

Heat shrink technology.....	11
Cast resin technology.....	71
Gel technology.....	113

LOW VOLTAGE

Heat shrink technology

	Straight-through joints	12
	Transition joints	29
	Pot end joints	31
	Cable terminations	33
	Wall ducts	40
	Heat shrinkable tubes	41
	Moulded parts	65



SMHSV

Heat shrinkable straight-through joint

with screw connectors (with shear head bolts), for unarmoured polymeric cables and conductors

Universally suitable for connecting polymeric cables or conductors insulated with PVC, PE and XLPE (e.g. N(A)YY, NYM, TT). With mechanical connectors with shear head bolts, suitable for aluminium or copper cables.

Characteristics

- Compact dimensions
- Wide conductor and cross-section range
- Resistant to chemical agents
- Resistant to alkaline earth elements
- Stabilized against UV rays
- Free from paint-wetting inhibiting substances
- Halogen-free
- Transversely waterproof
- High electrical insulating values
- High mechanical strength

Application/Suitability

- Indoor
- Outdoor
- Underground
- Water
- Installation ducts
- Ductwork

Voltage level

- U_o/U_m 0.6/1 (1.2) kV

Test standards

- DIN EN 50393 (corresponds to VDE 0278)

Storage conditions/Shelf life

- Unlimited shelf life

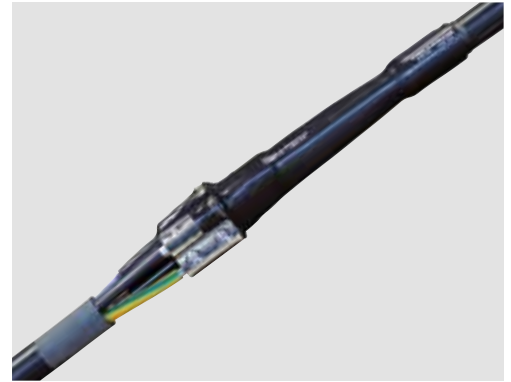

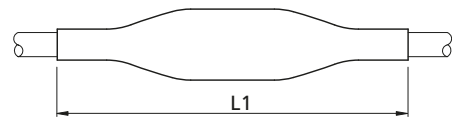

Dimensions



Scope of delivery

Outer sleeve, inner sleeves, screw connectors with shear head bolts, cleaning tissue, emery cloth, assembly instructions

		Polymeric cable unarmoured		
		 4x	 5x	
Type	L1 mm	Nominal cross section per conductor mm ²		Art.-No.
SMHSV4	6-50	500	6 - 50	294806
	16-95	650	16 - 95	262697
	50-150	800	50 - 150	262699
	95-240	1000	95 - 240	262710
	240-400	1100	240 - 400	349967
SMHSV5	6-50	800	6 - 50	357683
	16-95	900	16 - 95	357687
	50-150	1000	50 - 150	357689
	95-240	1200	95 - 240	357710

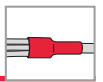

SMH...V

Heat shrinkable straight-through joint

with screw connectors, for unarmoured polymeric cables and conductors

Universally suitable for connecting polymeric cables or conductors insulated with PVC, PE and XLPE (e.g. N(A)YY, NYM, TT). With screw connectors with grub screw, suitable for aluminium and copper conductors.

Characteristics

- Compact dimensions
- Wide conductor and cross-section range
- Resistant to chemical agents
- Resistant to alkaline earth elements
- Stabilized against UV rays
- Free from paint-wetting inhibiting substances
- Halogen-free
- Transversely waterproof
- High electrical insulating values
- High mechanical strength

Application/Suitability

- Indoor
- Outdoor
- Underground
- Water
- Installation ducts
- Ductwork

Voltage level

- U_o/U_m 0.6/1 (1.2) kV

Test standards

- DIN EN 50393 (corresponds to VDE 0278)

Storage conditions/Shelf life

- Unlimited shelf life



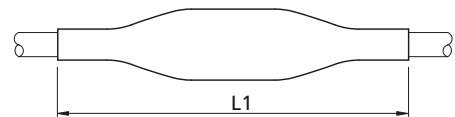

Dimensions



Scope of delivery

Outer sleeve, inner sleeves, screw connectors, allen key, cleaning tissue, emery cloth, assembly instructions

		Polymeric cable unarmoured			
		 4x	 5x		
Type	L1 mm	Nominal cross section per conductor mm ²		Art.-No.	
SMH4	1.5-6 V	250	1,5 - 6		348812
	6-35 V	400	6 - 35		145359
	25-70 V*	550	25 - 70		145360
	70-150 V	700	70 - 150		145361
SMH5	1.5-6 V	250		1,5 - 6	145362
	6-35 V	500		6 - 35	145363

*with screw connectors with shear head bolts

**SMH****Heat shrinkable straight-through joint**

for unarmoured polymeric cables and conductors

Universally suitable for connecting polymeric cables or conductors insulated with PVC, PE and XLPE (e.g. N(A)YY, NYM, TT). Suitable for compression connectors on aluminium or copper cables.

Characteristics

- Compact dimensions
- Wide conductor and cross-section range
- Resistant to chemical agents
- Resistant to alkaline earth elements
- Stabilized against UV rays
- Free from paint-wetting inhibiting substances
- Halogen-free
- Transversely waterproof
- High electrical insulating values
- High mechanical strength

Application/Suitability

- Indoor
- Outdoor
- Underground
- Water
- Installation ducts
- Ductwork

Voltage level

- U_0/U_m (U_m) 0.6/1 (1.2) kV

Test standards

- DIN EN 50393 (corresponds to VDE 0278)

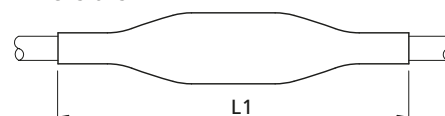

Storage conditions/Shelf life

- Unlimited shelf life

**Dimensions****Scope of delivery**

Outer sleeve, inner sleeves, cleaning tissue, emery cloth, assembly instructions

Optional accessory: Compression connectors (see Connecting technology)

		Polymeric cable unarmoured			
		 1x	 4x	 5x	
Type	L1 mm	Nominal cross section per conductor mm ²			Art.-No.
SMH1	35-70	400	35 - 70		150158
	95-240	500	95 - 240		150160
	150-300	500	150 - 300		150161
	300-500	600	300 - 500		150162
SMH4	1.5-6	200		1.5 - 6	145246
	1.5-16	400		1.5 - 16	145249
	6-25	500		6 - 25	145296
	16-50	600		16 - 50	145320
	25-95	600		25 - 95	145332
	25-150	700		25 - 150	145282
	95-300	1000		95 - 300	145342
SMH5	1.5-6	250		1.5 - 6	145255
	1.5-10	250		1.5 - 10	145257
	1.5-16	400		1.5 - 16	145338
	16-25	500		16 - 25	145295
	35-95	500		35 - 95	126745
	120-240	800		120 - 240	126665

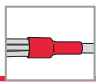

SMH

Heat shrinkable straight-through joint

with heat shrinkable crimp connectors, for control cables and signal cables

Universally suitable for connecting control cables and signal cables. With heat shrinkable crimp connectors on copper conductors.

Characteristics

- Compact dimensions
- Resistant to chemical agents
- Resistant to alkaline earth elements
- Stabilized against UV rays
- Free from paint-wetting inhibiting substances
- Halogen-free
- Transversely waterproof
- High electrical insulating values
- High mechanical strength

Application/Suitability

- Indoor
- Outdoor
- Underground
- Water
- Installation ducts
- Ductwork

Voltage level

- U_0/U_m (U_m) 0.6/1 (1.2) kV

Test standards

- DIN EN 50393 (corresponds to VDE 0278)

Storage conditions/Shelf life

- Unlimited shelf life



Dimensions

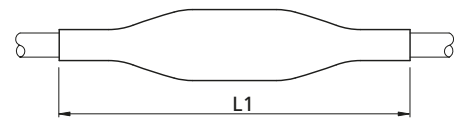

Scope of delivery

Outer sleeve, inner sleeves, heat shrinkable crimp connectors, cleaning tissue, emery cloth, assembly instructions

Control and signal cable

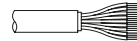

Type	L1 mm	Number of conductors	Nominal cross section per conductor mm ²	Art.-No.
SMH	7/10 1.5-2.5	7 - 10	1.5 - 2.5	145486
	12/14 1.5-2.5	12 - 14	1.5 - 2.5	145489
	18/24 1.5-2.5	18 - 24	1.5 - 2.5	145493



SMHA4

Heat shrinkable straight-through joint

for tape and wire armoured polymeric cables

Universally suitable for connecting armoured polymeric cables insulated with PVC, PE and XLPE (e.g. N(A)YY, NYM, TT). Suitable for compression connectors on aluminium and copper conductors.

Characteristics

- Compact dimensions
- Wide conductor and cross-section range
- Resistant to chemical agents
- Resistant to alkaline earth elements
- Stabilized against UV rays
- Free from paint-wetting inhibiting substances
- Halogen-free
- Transversely waterproof
- High electrical insulating values
- High mechanical strength

Application/Suitability

- Indoor
- Outdoor
- Underground
- Water
- Installation ducts
- Ductwork

Voltage level

- U_0/U_m (U_m) 0.6/1 (1.2) kV

Test standards

- DIN EN 50393 (corresponds to VDE 0278)

Storage conditions/Shelf life

- Unlimited shelf life



Dimensions

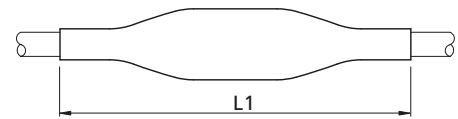

Scope of delivery

Outer sleeve, inner sleeves, armour crossover kit, cleaning tissue, emery cloth, assembly instructions

Optional accessory: Compression connectors (see Connecting technology)

Polymeric cable	
armoured	
 4x	

Type	L1 mm	Nominal cross section per conductor mm ²	Art.-No.
16-50	650	16 - 50	145243
35-150	850	35 - 150	130945
95-300	1000	95 - 300	174183

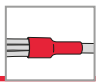

SMH...G

Heat shrinkable straight-through joint

for flexible cables

Universally suitable for connecting conductors insulated with EPR (e.g. A07RN-F, H07RN-F). Suitable for compression connectors.

Characteristics

- Compact dimensions
- Wide conductor and cross-section range
- Resistant to chemical agents
- Resistant to alkaline earth elements
- Stabilized against UV rays
- Free from paint-wetting inhibiting substances
- Halogen-free
- Transversely waterproof
- High electrical insulating values
- High mechanical strength

Application/Suitability

- Indoor
- Outdoor
- Underground
- Water
- Installation ducts
- Ductwork

Voltage level

- U_0/U_m (U_m) 0.6/1 (1.2) kV

Test standards

- DIN EN 50393 (corresponds to VDE 0278)

Storage conditions/Shelf life

- Unlimited shelf life



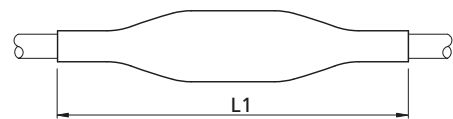

Dimensions



Scope of delivery

Outer sleeve, inner sleeves, filling material, cleaning tissue, emery cloth, assembly instructions

		Polymeric conductor unarmoured		
		 4x	 5x	
Type	L1 mm	Nominal cross section per conductor mm ²		Art.-No.
SMH4G	1.5-10	450	1.5 - 10	145479
	16-50	550	16 - 50	145481
	35-95	600	35 - 95	145482
	95-150	700	95 - 150	145552
SMH5G	1.5-10	500		1.5 - 10 145483
	10-25	600		10 - 25 145484
	16-50	600		16 - 50 163952
	70-120	700		70-120 205102

**SMHC...****Heat shrinkable straight-through joint**

for polymeric cables with concentric conductor

Universally suitable for connecting polymeric-insulated cables and conductors with concentric conductors and insulations made of PVC, PE and XLPE (e.g. N(A)YCY, N(A)YC(W)Y, GKN). Suitable for compression connectors.

Characteristics

- Compact dimensions
- Wide conductor and cross-section range
- Resistant to chemical agents
- Resistant to alkaline earth elements
- Stabilized against UV rays
- Free from paint-wetting inhibiting substances
- Halogen-free
- Transversely waterproof
- High electrical insulating values
- High mechanical strength

Application/Suitability

- Indoor
- Outdoor
- Underground
- Water
- Installation ducts
- Ductwork

Voltage level

- U_0/U_m 0.6/1 (1.2) kV

Test standards

- DIN EN 50393 (corresponds to VDE 0278)

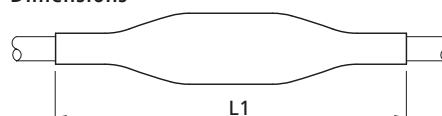

Storage conditions/Shelf life

- Unlimited shelf life

**Dimensions****Scope of delivery**

Outer sleeve, copper braid tape, inner sleeves, armour crossover kit, cleaning tissue, emery cloth, assembly instructions

Optional accessory: Compression connectors (see Connecting technology)

		Polymeric cable with concentric conductor				
						
Type		L1 mm	Nominal cross section per conductor mm ²		Art.-No.	
SMHC1	95-240	500	95/50 - 240/95			152521
	150-300	500	150/95 - 300/120			152522
SMHC3	4-10*	350	4/4 - 10/10			126672
	16-35*	500	16/16 - 35/35			126674
	50-95*	600	50/50 - 95/95			126675
	120-240*	1000	120/120 - 240/240			126676
SMHC4	4-10*	350			4/4 - 10/10	203028
	16-35*	500			16/16 - 35/16	203029
	50-95*	600			50/25 - 95/50	203040
	120-240*	1000			120/70 - 240/120	203041

*with additional inner tube

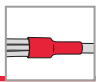

SMH...E90, SMHC...E90 Heat shrinkable straight-through joint

for cable systems E90 according to DIN standard 4102 Section 12

For connecting security cables type NHXH and NHXCH, anywhere where they are required, for example, in power plants, chemical plants, public buildings, airports, tunnels, off-shore installations, fire alarm systems, stairwells, elevator shafts. Suitable for compression connectors.

Characteristics

- Compact dimensions
- Resistant to chemical agents
- Resistant to alkaline earth elements
- Stabilized against UV rays
- Fire-resistant (see tests)
- Free from paint-wetting inhibiting substances
- Halogen-free
- Transversely waterproof
- High electrical insulating values
- Low smoke and gas emission

Application/Suitability

- Indoor
- Outdoor
- Underground
- Installation ducts
- Ductwork

Voltage level

- U_0/U_m 0.6/1 (1.2) kV

Test standards

- DIN VDE 0472 Section 814 (FE180)
- DIN 4102 Section 12(E90)
- IEC 60331-60332

Storage conditions/Shelf life

- Unlimited shelf life



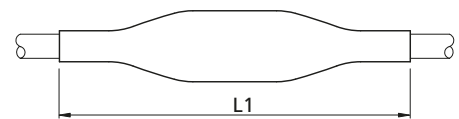

Dimensions



Scope of delivery

Inner sleeves, insulating tubes, outer sleeve, cleaning tissue, emery cloth, assembly instructions

Optional accessory: Compression connectors (see Connecting technology)

		Polymeric cable			
		unarmoured		with concentric conductor	
					
Type	L1 mm	Nominal cross section per conductor mm ²			Art.-No.
SMH4	1.5-4 E90	350	1.5 - 4		145653
	6-10 E90	380	6 - 10		145655
	16-25 E90	470	16 - 25		145656
	35-50 E90	500	35 - 50		145657
	70-95 E90	600	70 - 95		145659
	120-150 E90	600	120 - 150		145660
	185-240 E90	750	185 - 240		145661
SMH5	1.5-4 E90	350		1.5 - 4	145680
	6-10 E90	380		6 - 10	145681
	16-25 E90	470		16 - 25	145682
SMHC4	1.5-4 E90	350		1.5/1.5 - 4/4	145665
	6-10 E90	380		6/6 - 10/10	145666
	16-25 E90	470		16/16 - 25/16	145667
	35-50 E90	500		35/16 - 50/25	145668
	70-95 E90	600		70/35 - 95/50	145669
	120-150 E90	600		120/70 - 150/70	145670
	185-240 E90	750		185/95 - 240/120	145671



SMHF

Heat shrinkable straight-through joint

for telecommunication cables

For connecting or branching telecommunication cables insulated with PVC or PE (e.g. A-2YF(L)2Y, A-02YSF(L)2Y, A-PWE2Y, A-PM, A-PM2Y, A-PMbc). Suitable for wire connectors.

Characteristics

- Compact dimensions
- Suitable for cut and uncut cables
- Removable (for repairs or switch-over)
- Resistant to chemical agents
- Resistant to alkaline earth elements
- Stabilized against UV rays
- Free from paint-wetting inhibiting substances
- Halogen-free
- Waterproof and moisture-resistant

Application/Suitability

- Indoor areas (also with high humidity levels)
- Outdoor
- Underground
- Water
- Installation ducts
- Ductwork

Storage conditions/Shelf life

- Unlimited shelf life



Dimensions

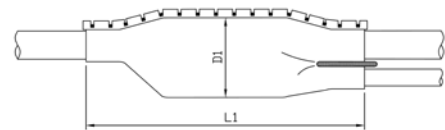

Scope of delivery

Heat shrinkable sleeve, flexible locking bar, protective liner, drying agent, shield continuity wire with clamps, fire protection film, PVC insulation tape, cleaning tissue, emery cloth, assembly instructions

Optional accessory: Wire connectors AVS (see Connecting technology)
Assembly kit MSFA (required for each branch)

Type	L1 mm	D1 Ø over protective liner mm	Cable-Ø mm	Telecommunication cable						Art.-No.
				spliced with wire connector			spliced with conductor connecting blocks			
				0.4 mm	0.6 mm	0.8 mm	0.4 mm	0.6 mm	0.8 mm	
SMHF	43-8/330	330	43	max. Number of wire pairs						145559
	43-8/570	570	43	30	20	10	40	30	20	145560
	68-15/380	380	68	70	40	20	100	70	30	145568
	68-15/690	690	68	100	50	30	150	100	50	145568
	93-25/400	400	93	150	100	50	250	150	70	145572
	93-25/690	690	93	150	100	70	400	250	100	145572
	120-28/430	430	120	200	200	100	500	300	150	145569
			28 - 94	200	200	150	500	300	200	145574

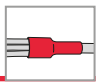

VASMI

Heat shrinkable straight-through joint

with temperature colour indicator, for telecommunication cables

For connecting or branching telecommunication cables insulated with PVC or PE (e.g. A-2YF(L)2Y, A-02YSF(L)2Y, A-PWE2Y, A-PM, A-PM2Y, A-PMbc). Suitable for wire connectors.

Characteristics

- Compact dimensions
- With temperature colour indicator
- Suitable for cut and uncut cables
- Removable (for repairs or switch-over)
- Resistant to chemical agents
- Resistant to alkaline earth elements
- Stabilized against UV rays
- Free from paint-wetting inhibiting substances
- Halogen-free
- Waterproof and moisture-resistant

Application/Suitability

- Indoor areas (also with high humidity levels)
- Outdoor
- Underground
- Water
- Installation ducts
- Ductwork

Storage conditions/Shelf life

- Unlimited shelf life



Dimensions

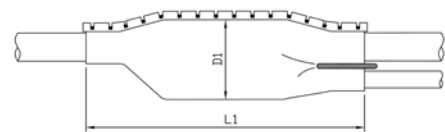

Scope of delivery

Heat shrinkable sleeve, flexible locking bar, protective liner, drying agent, shield continuity wire with clamps, fire protection film, PVC insulation tape, cleaning tissue, emery cloth, assembly instructions

Optional accessory: Wire connectors AVS (see Connecting technology)
Assembly kit MSFA (required for each branch)

Type	L1 mm	D1 Ø over protective liner mm	Cable-Ø mm	Telecommunication cable						Art.-No.	
				spliced with wire connector			spliced with conductor connecting blocks				
				0.4 mm	0.6 mm	0.8 mm	0.4 mm	0.6 mm	0.8 mm		
				max. Number of wire pairs							
VASMI	1 SRT	330	43	8 - 35	30	20	10	40	30	20	145562
	1 L SRT	390	43	8 - 35	70	40	20	100	70	30	145561
	2 SRT	380	68	15 - 55	100	50	30	150	100	50	145566
	2 L SRT	450	68	15 - 55	150	100	50	250	150	70	145565
	3 SRT	400	93	25 - 68	150	100	70	400	250	100	145571
	3 L SRT	500	93	25 - 68	200	200	100	500	300	150	145570



MSFA Assembly kit

for branching with heat shrinkable joints SMHF and VASMI

For creating branches in heat shrinkable joints for telecommunication cables.

Characteristics

- Universally suitable for different diameters and numbers of wire pairs

Application/Suitability

- For heat shrinkable joints SMHF and VASMI

Scope of delivery

Branching kit SAS 120, branch clamp, fire protection wrapping

Note: An assembly kit is required for each branch.



Type	Art.-No.
MSFA	145578

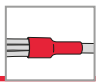

SM, SM-MA

Heat shrinkable universal straight-through joint

for polymeric cables, conductors and mass-impregnated paper cables

Universally suitable for connecting polymeric cables or conductors insulated with PVC, PE and XLPE (e.g. GKN, GN-CLN). With extra transition set to connect with mass-impregnated paper cables (GKN-PPb, GN-CLN-PPb). Suitable for compression connectors.

Characteristics

- Compact dimensions
- Wide conductor and cross-section range
- Resistant to chemical agents
- Resistant to alkaline earth elements
- Stabilized against UV rays
- Free from paint-wetting inhibiting substances
- Halogen-free
- Transversely waterproof
- High electrical insulating values
- High mechanical strength
- Ready for immediate operation

Application/Suitability

- Indoor
- Outdoor
- Underground
- Water
- Installation ducts
- Ductwork

Voltage level

- $U_0/U (U_m)$ 0.6/1 (1.2) kV

Note

- Straight-through joint for 4-core cables, e.g. GKN, GN-CLN

Test standards

- DIN EN 50393 (corresponds to VDE 0278)

Storage conditions/ Shelf life

- Unlimited shelf life

Scope of delivery

Outer sleeve, copper braid tape, inner protective sleeve (belt sleeve), inner sleeves, cleaning tissue, emery cloth, assembly instructions

Optional accessory: Compression connectors (see Connecting technology)
Accessory kit ZS-PPb (required for PPb cables)



Dimensions

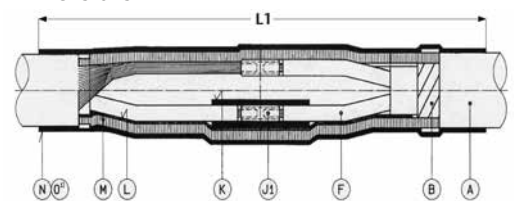

GKN – GN-CLN

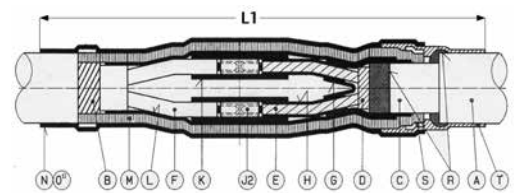

GN-CLN – PPb

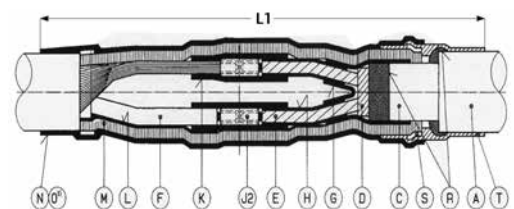

GKN – PPb

- A = Outer sheath
- B = CL armouring
- C = Lead sheath
- D = Paper belt
- E = Paper insulated conductor
- F = Conductor
- G = Spreader cap SEMH4
- H = Heat shrinkable tube SR2
- J1 = Connector
- J2 = Connector with separator
- K = Heat shrinkable tube SRH3
- L = High voltage insulation tape No. 62/38 mm
- M = Copper braid tape No. 63/60 mm
- N/O = Heat shrinkable cuff / Outer sleeve SRH2
- R = Mastic tape HKB
- S = High voltage insulation tape No. 62/19 mm
- T = Heat shrinkable tube SRH

→ Continued on the next page



→ Continuation

SM, SM-MA Heat shrinkable universal straight-through joint



Particularly for the Swiss market

Polymeric cable unarmoured / armoured		Mass-impregnated paper cable (with accessory kit ZS-PPb)
 4x		 4x

Type	L1 mm	Nominal cross section per conductor mm ²		Art.-No.	
Heat shrinkable tube for outer protection					
SM	4-10	400	4 - 10	4 - 10	126713
	16-50	500	16 - 50	16 - 35	126714
	50-95	750	50 - 95	50 - 95	126715
	95-150	850	95 - 150	95 - 150	180739
	120-240	1000	120 - 240	120 - 240	126716
Sleeve for outer protection					
SM-MA	16-50	500	16 - 50	16 - 35	126696
	50-95	750	50 - 95	50 - 95	126697
	95-150	850	95 - 150	95 - 150	180760
	120-240	1000	120 - 240	120 - 240	126698

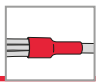

SMSV

Heat shrinkable universal straight-through joint

with screw connectors (with shear head bolts), for polymeric cables with concentric conductor

Universally suitable for connecting polymeric-insulated cables and conductors with concentric conductors and insulations made of PVC, PE and XLPE, e.g. GKN and GN-CLN.

Characteristics

- Compact dimensions
- Wide conductor and cross-section range
- Resistant to chemical agents
- Resistant to alkaline earth elements
- Stabilized against UV rays
- Free from paint-wetting inhibiting substances
- Halogen-free
- Transversely waterproof
- High electrical insulating values
- High mechanical strength
- Ready for immediate operation

Application/Suitability

- Indoor
- Outdoor
- Underground
- Water
- Installation ducts
- Ductwork

Voltage level

- U_0/U_m (U_m) 0.6/1 (1.2) kV

Test standards

- DIN EN 50393 (corresponds to VDE 0278)

Storage conditions/Shelf life

- Unlimited shelf life



Dimensions

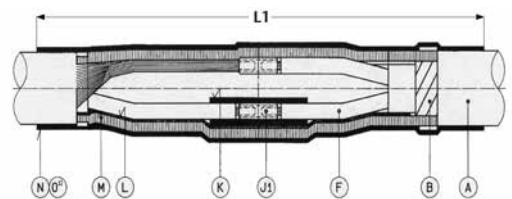

- A = Outer sheath
- B = CL armouring
- F = Conductor
- J1 = Connector
- K = Heat shrinkable tube SRH3
- L = High voltage insulation tape No. 62/38 mm
- M = Copper braid tape No. 63/60 mm
- N/O = Heat shrinkable cuff / Outer sleeve SRH2

Scope of delivery

Outer sleeve, copper braid tape, inner protective sleeve (belt sleeve), inner sleeves, screw connectors (with shear head bolts, cleaning tissue, emery cloth, assembly instructions)



Particularly for the Swiss market

Polymeric cable	
with concentric conductor	
 3x	

Type	L1 mm	Nominal cross section per conductor mm ²	Art.-No.	
SMSV	4-16	400	4 - 16	335141
	16-95	750	16 - 95	335143
	95-240	1000	95 - 240	335144



ZS-PPb Accessory kit

for mass-impregnated paper cables for heat shrinkable universal straight-through joints SM and SM-MA

To build a transition joint for mass-impregnated paper cables for the heat shrinkable universal straight-through joints.

Characteristics

- Compact dimensions
- Wide conductor and cross-section range
- Resistant to chemical agents
- Resistant to alkaline earth elements
- Stabilized against UV rays
- Free from paint-wetting inhibiting substances
- Halogen-free
- High electrical insulating values
- High mechanical strength

Application/Suitability

- For heat shrinkable universal straight-through joints SM and SM-MA

Voltage level

- $U_0/U (U_m)$ 0.6/1 (1.2) kV

Test standards

- DIN EN 50393 (corresponds to VDE 0278)



Scope of delivery

Spreader cap, heat shrinkable tubes, roughening strip



Particularly for the Swiss market

Type	Art.-No.	
ZS-PPb	4-10	126773
	16-35	126769
	25-50	366132
	50-95	126770
	95-150	180761
	120-240	126771

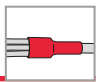

SMDH

Heat shrinkable straight-through joint

for armoured polymeric cables

Universally suitable for connecting light armoured polymeric cables insulated with PVC, PE and XLPE (e.g. GN-CLN). Suitable for compression connectors.

Characteristics

- Compact dimensions
- Wide conductor and cross-section range
- Resistant to chemical agents
- Resistant to alkaline earth elements
- Stabilized against UV rays
- Free from paint-wetting inhibiting substances
- Halogen-free
- Transversely waterproof
- High electrical insulating values
- High mechanical strength
- Ready for immediate operation

Application/Suitability

- Indoor
- Outdoor
- Underground
- Water
- Installation ducts
- Ductwork

Voltage level

- U_0/U_m (U_m) 0.6/1 (1.2) kV

Test standards

- DIN EN 50393 (corresponds to VDE 0278)

Storage conditions/Shelf life

- Unlimited shelf life



Dimensions

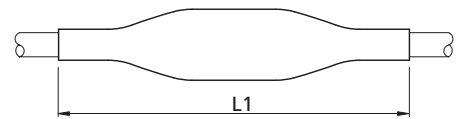

Scope of delivery

Outer sleeve, copper braid tape, inner protective sleeve (belt sleeve), inner sleeves, cleaning tissue, emery cloth, assembly instructions

Optional accessory: Compression connectors (see Connecting technology)



Polymeric cable	
armoured	
 4x	

Type	L1 mm	Nominal cross section per conductor mm ²	Art.-No.	
SMDH	1.5-10	330	1.5 - 10	126740
	16-35	500	16 - 35	126719
	50-95	800	50 - 95	126720
	120-240	1000	120 - 240	126721



EASY-FIX

SRMH Cable repair kit

for damaged cables and conductors

For fast connecting and insulation of drilled or otherwise damaged cables without the necessity to insert the new lines. The cable repair kit restores the electric and mechanical properties in the installed cable.

Characteristics

- With hot melt adhesive
- Resistant to chemical agents
- Stabilized against UV rays
- Free from paint-wetting inhibiting substances
- High flexibility
- High tensile strength
- Resistant to cold flow (thermally stable)
- Self-extinguishing

Application/Suitability

- For repairing of damaged sheaths of all plastic- and rubber-insulated cables and conductors

Storage conditions/Shelf life

- Unlimited shelf life





Scope of delivery

SRMH3: 1 heat shrinkable tube, 3 heat shrinkable crimp connectors, 4 cable ties

SRMH5: 1 heat shrinkable tube, 5 heat shrinkable crimp connectors, 5 cable ties

Note: Sales display with 20 SRMH cable repair kits, packed individually.

		Polymeric cable unarmoured		
		 3x	 5x	
Type		Nominal cross section per conductor mm ²		Art.-No.
SRMH	3	1.5 - 2.5		254684
	5	1.5 - 2.5		345619



SMH4...Pb-RF

Heat shrinkable transition joint

with solderless earthing wire connection, for polymeric cables and mass-impregnated paper cables

Universally suitable for transition from mass-impregnated paper cables to polymeric-insulated cables made of PVC, PE and XLPE, e.g. N(A)KBA on N(A)YY. Suitable for compression connectors on aluminium or copper cables.

Characteristics

- Compact dimensions
- Wide conductor and cross-section range
- Resistant to chemical agents
- Resistant to alkaline earth elements
- Stabilized against UV rays
- Free from paint-wetting inhibiting substances
- Halogen-free
- Transversely waterproof
- High electrical insulating values
- High mechanical strength

Application/Suitability

- Indoor
- Outdoor
- Underground
- Water
- Installation ducts
- Ductwork

Voltage level

- U_0/U_m 0.6/1 (1.2) kV

Test standards

- DIN EN 50393 (corresponds to VDE 0278)

Storage conditions/Shelf life

- Unlimited shelf life



Dimensions

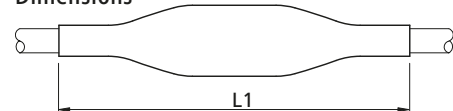

Scope of delivery

Outer sleeve, earthing wire, pressure spring, spreader cap, inner sleeves, core insulating tubes, cleaning tissue, emery cloth, assembly instructions

Optional accessory: Compression connectors (see Connecting technology)

Note: Use only connectors with separator.

Type	L1 mm	Polymeric cable	Mass-impregnated paper cable	Art.-No.	
		unarmoured			
		 4x	 4x		
		Nominal cross section per conductor mm ²			
SMH4	70-150 Pb-RF	1000	70 - 150	70 - 150	145354
	150-300 Pb-RF	1200	150 - 300	150 - 300	150826

**SMHSV4...Pb-RF****Heat shrinkable transition joint**

with screw connectors, with solderless earthing wire connection, for polymeric cables and mass-impregnated paper cables

Universally suitable for transition from mass-impregnated paper cables to polymeric-insulated cables made of PVC, PE and XLPE, e.g. NAKLEY, N(A)KBA on N(A)YY. With mechanical connectors with shear heads bolts suitable for aluminium or copper cables.

Characteristics

- Compact dimensions
- Wide conductor and cross-section range
- Resistant to chemical agents
- Resistant to alkaline earth elements
- Stabilized against UV rays
- Free from paint-wetting inhibiting substances
- Halogen-free
- Transversely waterproof
- High electrical insulating values
- High mechanical strength

Application/Suitability

- Indoor
- Outdoor
- Underground
- Water
- Installation ducts
- Ductwork

Voltage level

- U_0/U_m 0.6/1 (1.2) kV

Test standards

- DIN EN 50393 (corresponds to VDE 0278)

Storage conditions/Shelf life

- Unlimited shelf life

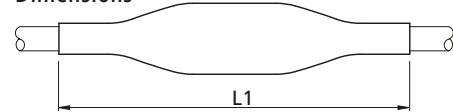
**Dimensions****Scope of delivery**

Outer sleeve, earthing wire, pressure spring, spreader cap, inner sleeves, screw connectors CSV-T with shear head bolts, core insulating tubes, cleaning tissue, emery cloth, assembly instructions

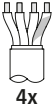
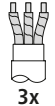
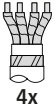
Type	L1 mm	Polymeric cable		Mass-impregnated paper cable		Art.-No.	
		unarmoured		NAKLEY	N(A)KBA		
			4x		3x		4x
		Nominal cross section per conductor					
		mm²					
SMHSV4	6-50 Pb-RF	750	6 - 50	6 - 50	6 - 35	268322	
	25-95 Pb-RF	900	25 - 95	25 - 95	25 - 70	268323	
	50-150 Pb-RF	1000	50 - 150	50 - 150	50 - 120	268324	
	95-240 Pb-RF	1200	95 - 240	95 - 240	95 - 185	307669	



SEMH...-K

Voltage-resistant pot end joint

with inner caps and outer cap, for polymeric cables and conductors

Universal pot end cable terminations of unarmoured polymeric-insulated cables and conductors as well as polymeric-insulated cables with concentric conductors with insulation made of PVC, PE and XLPE, e.g. N(A)YY, N(A)XY, TT, N(A)2Y2Y, N(A)2X2Y, N(A)YC(W)Y.

Characteristics

- Wide conductor and cross-section range
- Resistant to chemical agents
- Resistant to alkaline earth elements
- Stabilized against UV rays
- Free from paint-wetting inhibiting substances
- Halogen-free
- Transversely waterproof
- High electrical insulating values
- High mechanical strength

Application/Suitability

- Indoor
- Outdoor
- Underground
- Water
- Installation ducts
- Ductwork

Voltage level

- U_0/U_m 0.6/1 (1.2) kV

Test standards

- DIN EN 50393 (corresponds to VDE 0278)

Storage conditions/Shelf life

- Unlimited shelf life



Dimensions

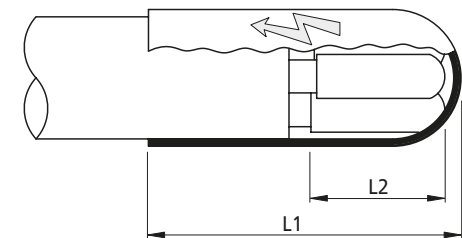

Scope of delivery

Sealing caps, heat shrinkable cap with voltage arrow, cleaning tissue, emery cloth, assembly instructions

Polymeric cable		
unarmoured		with concentric conductor
4x	5x	4x

Type	L1 mm	L2 mm	Nominal cross section per conductor mm ²	Art.-No.
SEMH4-K	6-35	47	6 - 35	145388
	35-150	75	35 - 150	145386
	185-300	100	185 - 300	145391
SEMH5-K	6-35	47	6 - 35	360710



SEMHK4...Pb

Voltage-resistant pot end joint

with inner cap, for mass-impregnated paper cables

Pot end cable terminations for mass-impregnated paper cables (e.g. N(A)KBA, NAKLEY, PPb).

Characteristics

- Wide conductor and cross-section range
- Resistant to chemical agents
- Resistant to alkaline earth elements
- Stabilized against UV rays
- Free from paint-wetting inhibiting substances
- Halogen-free
- Transversely waterproof
- High electrical insulating values
- High mechanical strength

Application/Suitability

- Indoor
- Outdoor
- Underground
- Water
- Installation ducts
- Ductwork

Voltage level

- U_0/U_m 0.6/1 (1.2) kV

Test standards

- DIN EN 50393 (corresponds to VDE 0278)

Storage conditions/Shelf life

- Unlimited shelf life



Dimensions

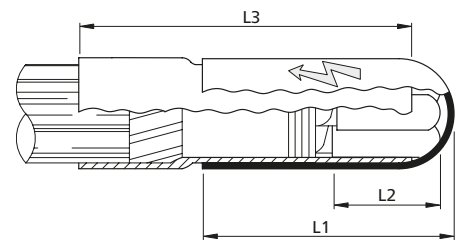

Scope of delivery

Sealing tube, heat shrinkable cap with voltage arrow, sealing caps, cleaning tissue, emery cloth, assembly instructions

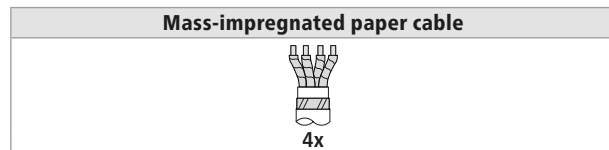

Type	L1 mm	L2 mm	L3 mm	Nominal cross section per conductor mm ²	Art.-No.	
SEMHK4	16-50 Pb	75	50	200	16 - 50	145396
	70-120 Pb	145	70	200	70 - 120	145397
	95-300 Pb	140	100	250	95 - 300	145398

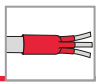

SFEX

Heat shrinkable cable termination

for unarmoured polymeric cables and conductors

Universally suitable for connecting the polymeric-insulated cables to electrical equipment, for cables insulated with PE, XLPE, PVC and cable sheaths insulated with PVC or PE. Suitable for compression cable lugs on aluminium and copper cables.

Characteristics

- Compact dimensions
- Wide conductor and cross-section range
- Resistant to chemical agents
- Stabilized against UV rays
- Free from paint-wetting inhibiting substances
- Halogen-free
- 100 % waterproof
- High electrical insulating values
- High mechanical strength

Application/Suitability

- Outdoor

Voltage level

- U_0/U_m 0.6/1 (1.2) kV

Note

- SFEX4 for power cables and conductors with green-yellow wire marking

Test standards

- DIN EN 50393 (corresponds to VDE 0278)

Storage conditions/Shelf life

- Unlimited shelf life



Dimensions

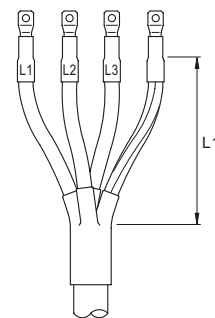

Scope of delivery

Core insulating tubes, spreader cap, sealing tubes, cleaning tissue, emery cloth, assembly instructions

Optional accessory: Compression cable lugs (see Connecting technology)

Note: Waterproof cable lugs must be used for outdoor cable terminations.

		Polymeric cable unarmoured		
		 4x		
Type	L1 mm	Nominal cross section per conductor mm ²		Art.-No.
SFEX4	25-50	25 - 50		145439
	70-150	70 - 150		145444
	150-300	150 - 300		145449



SFEH

Heat shrinkable cable termination

for unarmoured polymeric cables

Universally suitable to terminate polymeric cables and electrical equipment. Suitable for cables insulated with PE, VPE, PVC und cable sheaths insulated with PVC or PE suitable for compression lugs on aluminium and copper conductors.

Characteristics

- Compact dimensions
- Wide conductor and cross-section range
- Resistant to chemical agents
- Stabilized against UV rays
- Free from paint-wetting inhibiting substances
- Halogen-free
- High electrical insulating values
- High mechanical strength

Application/Suitability

- Indoor

Voltage level

- U_0/U_m 0.6/1 (1.2) kV

Test standards

- DIN EN 50393 (corresponds to VDE 0278)

Storage conditions/Shelf life

- Unlimited shelf life



Dimensions

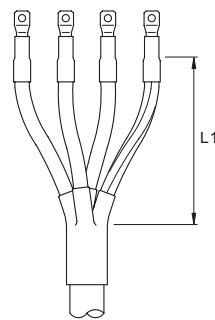

L1 = user-defined

Scope of delivery

Spreader cap, sealing tubes, cleaning tissue, emery cloth, assembly instructions

Optional accessory: Compression cable lugs (see Connecting technology)

Polymeric cable	
unarmoured	
 4x	

Type	Nominal cross section per conductor		Art.-No.
	mm ²		
SFEH4	25-50	25 - 50	145438
	70-150	70 - 150	145443
	150-300	150 - 300	145448

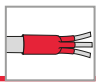

SEH4...V-S

Heat shrinkable indoor cable termination

for armoured polymeric cables

For connecting polymeric cables to distribution cupboards and panels. Suitable for PVC and XLPE insulated cables and PVC and PE cable sheaths with protective armouring (e.g. GN-CLN). Suitable for compression lugs on aluminium and copper conductors.

Characteristics

- Compact dimensions
- Wide conductor and cross-section range
- Resistant to chemical agents
- Stabilized against UV rays
- Free from paint-wetting inhibiting substances
- Halogen-free
- Transversely waterproof
- High electrical insulating values
- High mechanical strength
- Ready for immediate operation

Application/Suitability

- Indoor
- Voltage level**
- U_0/U_m 0.6/1 (1.2) kV
- Test standards**
- DIN EN 50393 (corresponds to VDE 0278)
- Storage conditions/Shelf life**
- Unlimited shelf life

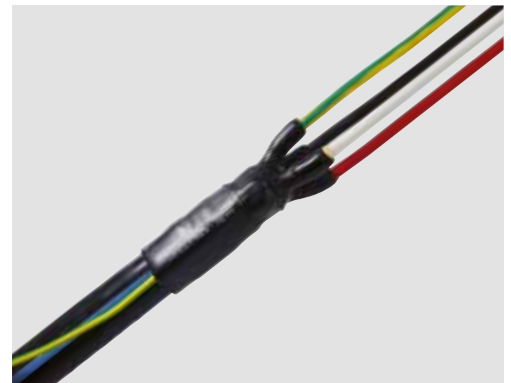

Dimensions

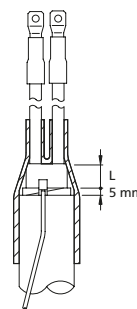

Scope of delivery

Sealing tubes, spreader cap, cleaning tissue, emery cloth, assembly instructions

Optional accessory: Compression cable lugs (see Connecting technology)



Particularly for the
Swiss market

		Polymeric cable armoured		
		 4x		
Type	L mm	Nominal cross section per conductor mm ²		Art.-No.
SEH4	10-35 V-S	10 - 35		131999
	95-150 V-S	95 - 150		126821

**SEH4...V-C****Heat shrinkable indoor cable termination**

for polymeric cables with concentric conductor

For connecting polymeric cables to distribution cupboards and panels. Suitable for PVC and XLPE insulated cables and PVC and PE cable sheaths with concentric conductor (e.g. GKN). Suitable for compression lugs on aluminium and copper conductors.

Characteristics

- Compact dimensions
- Wide conductor and cross-section range
- Resistant to chemical agents
- Stabilized against UV rays
- Free from paint-wetting inhibiting substances
- Halogen-free
- Transversely waterproof
- High electrical insulating values
- High mechanical strength
- Ready for immediate operation

Application/Suitability

- Indoor

Voltage level

- U_0/U_m 0.6/1 (1.2) kV

Test standards

- DIN EN 50393 (corresponds to VDE 0278)

Storage conditions/Shelf life

- Unlimited shelf life

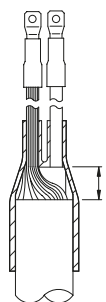
**Dimensions****Scope of delivery**

Sealing tubes, heat shrinkable tube (Green-Yellow), spreader cap, cleaning tissue, emery cloth, assembly instructions

Optional accessory: Compression cable lugs (see Connecting technology)



Particularly for the
Swiss market

**Polymeric cable
with concentric conductor**

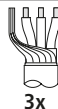

3x

Type	L mm	Nominal cross section per conductor mm ²	Art.-No.
SEH4	10-35 V-C	10/10 - 35/35	126822
	50-95 V-C	50/50 - 95/95	126823
	120-240 V-C	120/70 - 240/120	126824

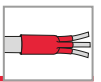

SEH4...S-C

Heat shrinkable indoor cable termination

for polymeric cables with concentric conductor

For connecting polymeric cables to distribution cupboards and panels. Suitable for PVC and XLPE insulated cables and PVC and PE cable sheaths with concentric conductor (e.g. GKN). Suitable for compression lugs on aluminium and copper conductors.

Characteristics

- Compact dimensions
- Wide conductor and cross-section range
- Resistant to chemical agents
- Stabilized against UV rays
- Free from paint-wetting inhibiting substances
- Halogen-free
- Transversely waterproof
- High electrical insulating values
- High mechanical strength
- Ready for immediate operation

Application/Suitability

- Indoor
- Voltage level**
- U_0/U_m 0.6/1 (1.2) kV
- Test standards**
- DIN EN 50393 (corresponds to VDE 0278)
- Storage conditions/Shelf life**
- Unlimited shelf life



Dimensions

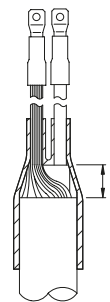

Scope of delivery

Sealing tubes, heat shrinkable tube (Green-Yellow), spreader cap, cleaning tissue, emery cloth, assembly instructions

Optional accessory: Compression cable lugs (see Connecting technology)



Particularly for the
Swiss market

		Polymeric cable with concentric conductor			
		 3x			
Type	L mm	Nominal cross section per conductor mm ²		Art.-No.	
SEH4	10-35 S-C	20	10/10 - 35/35		126855
	50-95 S-C	20	50/50 - 95/95		126856
	95-150 S-C	20	95/50 - 150/70		126847

**SEH4...A+Z****Heat shrinkable indoor and outdoor cable termination**

for polymeric cable with concentric conductor and armoured polymeric cables, with connectors

Universally suitable for connecting polymeric cables and cable sheaths insulated with PVC and PE with concentric conductor (e.g. GKN) or protective armour (e.g. GN-CLN). Suitable for compression lugs or compression connectors on aluminium and copper conductors.

Characteristics

- Compact dimensions
- Wide conductor and cross-section range
- Resistant to chemical agents
- Stabilized against UV rays
- Free from paint-wetting inhibiting substances
- Halogen-free
- Transversely waterproof
- High electrical insulating values
- High mechanical strength
- Ready for immediate operation

Application/Suitability

- Indoor
- Outdoor
- For double compression connectors with separators complying with DIN 46267

Voltage level

- U_0/U_m 0.6/1 (1.2) kV

Test standards

- DIN EN 50393 (corresponds to VDE 0278)

Storage conditions/Shelf life

- Unlimited shelf life

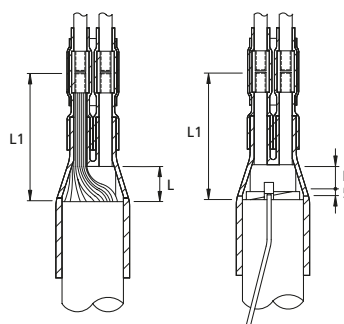
**Dimensions****Scope of delivery**



Sealing tubes, spreader cap, core insulating tubes, double compression connectors (according to type, on choice), cleaning tissue, emery cloth, assembly instructions

Optional accessory: Compression cable lugs (see Connecting technology)
Compression connectors (see Connecting technology)

Note: Use only connectors with separator.



Particularly for the
Swiss market

Polymeric cable	
with concentric conductor	armoured
 3x	 4x

Type	L mm	L1 mm	Nominal cross section per conductor mm ²		Art.-No.	
incl. 4 compression type connectors with separator						
SEH4	25 A+Z	20	85	25/25	25	126805
	35 A+Z	20	105	35/35	35	126806
	50 A+Z	20	105	50/50	50	126807

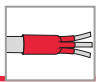

SR2LK, SR2LK-PEN Heat shrinkable tube kit

for phase marking

Universally suitable for phase marking, for polymeric-insulated cables and conductors in connection area.

Characteristics

- Resistant to chemical agents
- Stabilized against UV rays
- Halogen-free
- Non-corrosive
- Infusible
- Superior electrical properties
- High mechanical strength
- Resistant to cold flow (thermally stable)

Application/Suitability

- Phase marking

Material

- Cross-linked polyolefin

- Free of lead and cadmium

Storage conditions/Shelf life

- Unlimited shelf life



Colours



Black

Scope of delivery

SR2LK: Black heat shrinkable tube with white markings,
1 kit = L1, L2, L3, N per each piece

SR2LK-PEN: Black heat shrinkable tube with white markings,
1 kit = L1, L2, L3, PEN per each piece

Note: Green-Yellow heat shrinkable tube with black inscription on request.

Type	L mm	Inner-Ø mm		Recovered wall thickness mm	Art.-No.
		before shrinking	after shrinking		
Imprint: L1, L2, L3, N					
SR2LK	25-70	50	22	6	145093
	70-240	80	40	12	145096
	150-500	125	56	17	145097
Imprint: L1, L2, L3, PEN					
SR2LK-PEN	25-70	50	22	6	165612
	70-240	80	40	12	154982
	150-500	125	56	16	193872

**SHE****Heat shrinkable wall duct**

for cables and conductors

Universally suitable for insertion of all types of cables and conduits through building walls.

Characteristics

- Wide conductor and cross-section range
- Extension possible
- Sealant-coated on the inside
- Resistant to alkaline earth elements
- Stabilized against UV rays
- Free from paint-wetting inhibiting substances
- Halogen-free
- 100 % waterproof
- Longitudinally watertight up to 1.0 bar
- High mechanical strength

Application/Suitability

- Mechanical protection for cables and conduits routed through walls

Note

- For very thick walls two wall ducts may be joined together. To seal the wall duct, we recommend our putty/sealing compound LG or universal sealing compound Duct Seal and to centre the wall duct to use our KZ centering aid, which consists of PE foam.

Storage conditions/Shelf life

- Unlimited shelf life

**Scope of delivery**

Wall duct, assembly instructions

Optional accessory: Putty/sealing compound LG (see Accessories)
 Universal sealing compound DUCT SEAL (see Accessories)
 Centring aid KZ (see Accessories)

Type	L1 mm	Cable-Ø mm	Inner-Ø mm		max. Wall thickness mm	Wall breakthrough mm	Art.-No.	
			before shrinking	after shrinking				
SHE	14-8	800	8 - 14	25	6	500	40	145600
	26-12	800	12 - 26	35	10	500	55	145604
	41-16	800	16 - 41	47	16	500	70	145616
	54-26	800	26 - 54	65	25	500	90	145611
	95-54	800	54 - 95	115	35	500	140	145614



Overview: BBC Cellpack Heat shrinkable tubes

Products	Properties					
	with adhesive	without adhesive	black	coloured	halogen-free	self-extinguishing
Thin wall heat shrinkable tubes						
Shrink ratio 2:1						
SRC1	–	●	●	–	●	–
SR1F	–	●	●	●	–	●
SB	–	●	●	●	–	●
SBS	–	●	●	–	–	●
MBS	–	●	●	– / ●	● / –	– / ●
Shrink ratio 3:1						
SR1F3	–	●	●	●	–	●
SB	–	●	●	●	–	●
Medium wall heat shrinkable tubes						
Shrink ratio 3:1						
SRUM	●	–	●	–	–	●
SR2	–	●	●	●	●	–
SRH2	●	–	●	–	●	–
SRFH2	●	–	●	–	–	●
MMK	●	–	●	–	–	●
Shrink ratio 4:1						
SRUM	●	–	●	–	–	●
Thick wall heat shrinkable tubes						
Shrink ratio 3:1						
SR3	–	●	●	–	●	–
SRH3	●	–	●	–	●	–
SRFH3	●	–	●	–	–	●
SRBK	●	–	●	–	●	–

- available
- not available

**SRC1****Heat shrinkable thin wall tube**

halogen-free, shrink ratio 2 : 1, without adhesive

Characteristics

- Thin wall
- Inscrutable
- Resistant to chemical agents
- Stabilized against UV rays
- Free from paint-wetting inhibiting substances
- Halogen-free
- Non-corrosive
- Infusible
- High flexibility
- Superior electrical properties
- High tensile strength
- Resistant to cold flow (thermally stable)

Application/Suitability

- Insulating
- Bundling
- Marking
- Corrosion protection
- Mechanical protection

Material

- Cross-linked polyolefin
- Free of lead and cadmium

Test standards

- Corresponds to MIL-I-23053/5 class 1 and 2

Storage conditions/Shelf life

- Unlimited shelf life

**Colours**

Black

Scope of delivery

Thin wall heat shrinkable tube, on spool or in lengths

Note: A standard spool may include sections which have been tied together.
Other lengths available on request.

Type	L m	Inner-Ø inch before shrinking	Inner-Ø mm		Recovered wall thickness mm	Art.-No.
			before shrinking	after shrinking		
Spool Colour: Black						
SRC1	1.2-0.6	300	3/64	1,2	0,6	145102
	1.6-0.8	300	1/16	1,6	0,8	145103
	2.4-1.2	300	3/32	2,4	1,2	145104
	3.2-1.6	300	1/8	3,2	1,6	145105
	4.8-2.4	300	3/16	4,8	2,4	145106
	6.4-3.2	300	1/4	6,4	3,2	145107
	9.5-4.8	150	3/8	9,5	4,8	145108
	12.7-6.4	100	1/2	12,7	6,4	145111
	19.1-9.5	50	3/4	19,1	9,5	145115
	25.4-12.7	50	1	25,4	12,7	145116
	38.1-19.1	50	1 1/2	38,1	19,1	145118
51.0-25.4	25	2	51	25,4	145119	
Lengths Colour: Black						
SRC1	1.2-0.6	1	3/64	1,2	0,6	145120
	1.6-0.8	1	1/16	1,6	0,8	145121
	2.4-1.2	1	3/32	2,4	1,2	145122
	3.2-1.6	1	1/8	3,2	1,6	145123
	4.8-2.4	1	3/16	4,8	2,4	145124
	6.4-3.2	1	1/4	6,4	3,2	145125
	9.5-4.8	1	3/8	9,5	4,8	145126
	12.7-6.4	1	1/2	12,7	6,4	145127
	19.1-9.5	1	3/4	19,1	9,5	145128
	25.4-12.7	1	1	25,4	12,7	145129
	38.1-19.1	1	1 1/2	38,1	19,1	145130
51.0-25.4	1	2	51	25,4	145131	

→ Continued on the next page



→ Continuation

SRC1 Heat shrinkable thin wall tube

Technical data	Value	Test standard
Physical properties		
Elongation at break	200 %	ASTM D 638
Tensile strength at break	10 MPa	ASTM D 638
Longitudinal shrinkage	≤ 10 %	ASTM D 2671
Shrink ratio	2:1	
Thermal properties		
Operating temperature range	-30 °C up to 105 °C	IEC 216
Shrinkage temperature	> 90 °C	CPT Test
Flexibility at low temperatures	-30 °C	ASTM-D 2671 C
Electrical properties		
Specific volume resistivity	10 ¹⁴ Ω x cm	ASTM D 257
Chemical properties		
Corrosion	None	ASTM D 2671 B
Resistance to fungus and decay	No growth	AMS-DTL-7444

**SR1F****Heat shrinkable thin wall tube**

self-extinguishing, shrink ratio 2 : 1, without adhesive

Characteristics

- Thin wall
- Inscrutable
- Resistant to chemical agents
- Stabilized against UV rays
- Free from paint-wetting inhibiting substances
- Non-corrosive
- Infusible
- High flexibility
- Superior electrical properties
- High tensile strength
- Resistant to cold flow (thermally stable)
- Self-extinguishing (except transparent)

Application/Suitability

- Insulating
- Bundling
- Marking
- Corrosion protection
- Mechanical protection

Material

- Cross-linked polyolefin
- Free of lead and cadmium

Test standards

- Approved according to UL File No.: E 172094

- Corresponds to MIL-I-23053/5 class 1

Storage conditions/Shelf life

- Unlimited shelf life

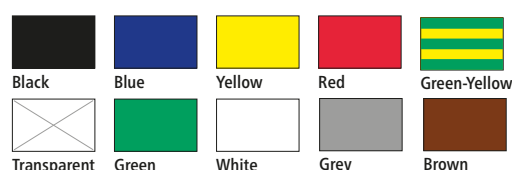
**Colours****Scope of delivery**

Thin wall heat shrinkable tube, on spool or in lengths

Note: A standard spool may include sections which have been tied together.
Other lengths available on request.

Type	L m	Inner-Ø inch before shrinking	Inner-Ø mm		Recovered wall thickness mm	Art.-No.
			before shrinking	after shrinking		
Spool Colour: Black						
SR1F	1.6-0.8	300	1/16	1,6	0,8	126954
	2.4-1.2	300	3/32	2,4	1,2	126960
	3.2-1.6	300	1/8	3,2	1,6	126961
	4.8-2.4	300	3/16	4,8	2,4	126969
	6.4-3.2	300	1/4	6,4	3,2	126891
	9.5-4.8	150	3/8	9,5	4,8	126899
	12.7-6.4	100	1/2	12,7	6,4	126907
	19.1-9.5	50	3/4	19,1	9,5	126916
	25.4-12.7	50	1	25,4	12,7	126924
	38.1-19.1	50	1 1/2	38,1	19,1	126932
	51.0-25.4	25	2	51	25,4	126940
76.0-38.0	25	3	76	38	126945	
102.0-51.0	25	4	102	51	126950	
Lengths Colour: Black						
SR1F	1.2-0.6	1	3/64	1,2	0,6	457265
	1.6-0.8	1	1/16	1,6	0,8	457266
	2.4-1.2	1	3/32	2,4	1,2	457267
	3.2-1.6	1	1/8	3,2	1,6	457268
	4.8-2.4	1	3/16	4,8	2,4	457269
	6.4-3.2	1	1/4	6,4	3,2	457280
	9.5-4.8	1	3/8	9,5	4,8	457281
	12.7-6.4	1	1/2	12,7	6,4	457282
	19.1-9.5	1	3/4	19,1	9,5	457283
	25.4-12.7	1	1	25,4	12,7	457284
	38.1-19.1	1	1 1/2	38,1	19,1	457285
	51.0-25.4	1	2	51	25,4	457286
	76.0-38.0	1	3	76	38	457287
102.0-51.0	1	4	102	51	457288	
Lengths Colour: Green-Yellow						
SR1F	1.2-0.6	1	3/64	1,2	0,6	457289
	1.6-0.8	1	1/16	1,6	0,8	457290

→ Continued on the next page



Type	L m	Inner-Ø inch before shrinking	Inner-Ø mm before shrinking	Inner-Ø mm after shrinking	Recovered wall thickness mm	Art.-No.	
(Continuation) Lengths Colour: Green-Yellow							
SR1F	2.4-1.2	1	3/32	2,4	1,2	0,51	457291
	3.2-1.6	1	1/8	3,2	1,6	0,51	457292
	4.8-2.4	1	3/16	4,8	2,4	0,52	457293
	6.4-3.2	1	1/4	6,4	3,2	0,64	457294
	9.5-4.8	1	3/8	9,5	4,8	0,64	457295
	12.7-6.4	1	1/2	12,7	6,4	0,64	457296
	19.1-9.5	1	3/4	19,1	9,5	0,76	457297
	25.4-12.7	1	1	25,4	12,7	0,89	457298
	38.1-19.1	1	1 1/2	38	19	1,02	457299
51.0-25.4	1	2	51	25	1,14	457300	
Lengths Colour: Red							
SR1F	2.4-1.2	1	3/32	2,4	1,2	0,51	457322
	3.2-1.6	1	1/8	3,2	1,6	0,51	457323
	4.8-2.4	1	3/16	4,8	2,4	0,52	457324
	6.4-3.2	1	1/4	6,4	3,2	0,64	457325
	9.5-4.8	1	3/8	9,5	4,8	0,64	457326
	12.7-6.4	1	1/2	12,7	6,4	0,64	457327
	19.1-9.5	1	3/4	19,1	9,5	0,76	457328
	25.4-12.7	1	1	25,4	12,7	0,89	457329
	38.1-19.1	1	1 1/2	38,1	19,1	1,02	457330
51.0-25.4	1	2	51	25,4	1,14	457331	
Lengths Colour: Blue							
SR1F	2.4-1.2	1	3/32	2,4	1,2	0,51	457312
	3.2-1.6	1	1/8	3,2	1,6	0,51	457313
	4.8-2.4	1	3/16	4,8	2,4	0,52	457314
	6.4-3.2	1	1/4	6,4	3,2	0,64	457315
	9.5-4.8	1	3/8	9,5	4,8	0,64	457316
	12.7-6.4	1	1/2	12,7	6,4	0,64	457317
	19.1-9.5	1	3/4	19,1	9,5	0,76	457318
	25.4-12.7	1	1	25,4	12,7	0,89	457319
	38.1-19.1	1	1 1/2	38,1	19,1	1,02	457320
51.0-25.4	1	2	51	25,4	1,14	457321	
Lengths Colour: Yellow							
SR1F	3.2-1.6	1	1/8	3,2	1,6	0,51	457364
	4.8-2.4	1	3/16	4,8	2,4	0,52	457365
	6.4-3.2	1	1/4	6,4	3,2	0,64	457366
	9.5-4.8	1	3/8	9,5	4,8	0,64	457367
	12.7-6.4	1	1/2	12,7	6,4	0,64	457368
	19.1-9.5	1	3/4	19,1	9,5	0,76	457369
	25.4-12.7	1	1	25,4	12,7	0,89	457370
	38.1-19.1	1	1 1/2	38,1	19,1	1,02	457371
Lengths Colour: Transparent							
SR1F	2.4-1.2	1	3/32	2,4	1,2	0,51	457301
	3.2-1.6	1	1/8	3,2	1,6	0,51	457302
	4.8-2.4	1	3/16	4,8	2,4	0,52	457303
	6.4-3.2	1	1/4	6,4	3,2	0,64	457304
	12.7-6.4	1	1/2	12,7	6,4	0,64	457305
	19.1-9.5	1	3/4	19,1	9,5	0,76	457306
	25.4-12.7	1	1	25,4	12,7	0,89	457307
	38.1-19.1	1	1 1/2	38,1	19,1	1,02	457308
	51.0-25.4	1	2	51	25,4	1,14	457309
	76.0-38.0	1	3	76	38	1,27	457310
	102.0-51.0	1	4	102	51	1,40	457311
Lengths Colour: White							
SR1F	2.4-1.2	1	3/32	2,4	1,2	0,51	457332
	3.2-1.6	1	1/8	3,2	1,6	0,51	457333
	4.8-2.4	1	3/16	4,8	2,4	0,52	457334
	6.4-3.2	1	1/4	6,4	3,2	0,64	457336
	9.5-4.8	1	3/8	9,5	4,8	0,64	457337
	12.7-6.4	1	1/2	12,7	6,4	0,64	457338
	19.1-9.5	1	3/4	19,1	9,5	0,76	457339
	25.4-12.7	1	1	25,4	12,7	0,89	457340

→ Continued on the next page



Type	L m	Inner-Ø inch before shrinking	Inner-Ø mm		Recovered wall thickness mm	Art.-No.	
			before shrinking	after shrinking			
(Continuation) Lengths Colour: White							
SR1F	38.1-19.1	1	1 1/2	38,1	19,1	1,02	457341
	51.0-25.4	1	2	51	25,4	1,14	457342
Lengths Colour: Grey							
SR1F	2.4-1.2	1	3/32	2,4	1,2	0,51	457343
	3.2-1.6	1	1/8	3,2	1,6	0,51	457344
	4.8-2.4	1	3/16	4,8	2,4	0,52	457345
	6.4-3.2	1	1/4	6,4	3,2	0,64	457346
	9.5-4.8	1	3/8	9,5	4,8	0,64	457347
	12.7-6.4	1	1/2	12,7	6,4	0,64	457348
	19.1-9.5	1	3/4	19,1	9,5	0,76	457349
	25.4-12.7	1	1	25,4	12,7	0,89	457350
	38.1-19.1	1	1 1/2	38,1	19,1	1,02	457351
	51.0-25.4	1	2	51	25,4	1,14	457353
Lengths Colour: Brown							
SR1F	3.2-1.6	1	1/8	3,2	1,6	0,51	457356
	4.8-2.4	1	3/16	4,8	2,4	0,52	457357
	6.4-3.2	1	1/4	6,4	3,2	0,64	457358
	9.5-4.8	1	3/8	9,5	4,8	0,64	457359
	12.7-6.4	1	1/2	12,7	6,4	0,64	457360
	19.1-9.5	1	3/4	19,1	9,5	0,76	457361
	25.4-12.7	1	1	25,4	12,7	0,89	457362
	38.1-19.1	1	1 1/2	38,1	19,1	1,02	457363
Lengths Colour: Green							
SR1F	3.2-1.6	1	1/8	3,2	1,6	0,51	457372
	4.8-2.4	1	3/16	4,8	2,4	0,52	457373
	6.4-3.2	1	1/4	6,4	3,2	0,64	457374
	9.5-4.8	1	3/8	9,5	4,8	0,64	457375
	12.7-6.4	1	1/2	12,7	6,4	0,64	457376
	19.1-9.5	1	3/4	19,1	9,5	0,76	457377
	25.4-12.7	1	1	25,4	12,7	0,89	457378
	38.1-19.1	1	1 1/2	38,1	19,1	1,02	457379

Technical data	Value	Test standard
Physical properties		
Elongation at break	350 %	ASTM D 638
Tensile strength at break	13 MPa	ASTM D 638
Longitudinal shrinkage	≤ 10 %	ASTM D 2671
Shrink ratio	2:1	IEC 811-1-1
Thermal properties		
Operating temperature range	-55 °C up to 135 °C	IEC 216
Shrinkage temperature	> 90 °C	CPT Test
Burning behaviour	self-extinguishing	UL 224
Flexibility at low temperatures	-55 °C	ASTM-D 2671 C
Electrical properties		
Dielectric strength	20 kV/mm	ASTM D 2671
Specific volume resistivity	10 ¹⁴ Ω x cm	ASTM D 257
Chemical properties		
Corrosion	None	ASTM D 2671 B
Resistance to fungus and decay	No growth	AMS-DTL-7444



SR1F3

Heat shrinkable thin wall tube

self-extinguishing, shrink ratio 3 : 1, without adhesive

Characteristics

- Thin wall
- Inscrutable
- Resistant to chemical agents
- Stabilized against UV rays
- Free from paint-wetting inhibiting substances
- Non-corrosive
- Infusible
- High flexibility
- Superior electrical properties
- High tensile strength
- Resistant to cold flow (thermally stable)
- Self-extinguishing (except transparent)

Application/Suitability

- Insulating
- Bundling
- Marking
- Corrosion protection
- Mechanical protection

Material

- Cross-linked polyolefin
- Free of lead and cadmium

Test standards

- Approved according to UL File No.: E 172094
- Corresponds to MIL-I-23053/5 class 1

Storage conditions/Shelf life

- Unlimited shelf life



Colours

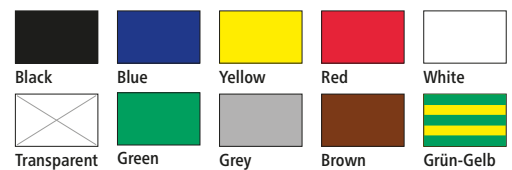

Scope of delivery

Thin wall heat shrinkable tube, on spool or in lengths

Note: A standard spool may include sections which have been tied together. Other lengths available on request.

Type	L m	Inner-Ø mm		Recovered wall thickness mm	Art.-No.	
		before shrinking	after shrinking			
Spool Colour: Black						
SR1F3	1.5-0.5	300	1.5	0.5	0.45	126977
	3.0-1.0	300	3	1	0.55	127242
	6.0-2.0	300	6	2	0.65	126990
	9.0-3.0	150	9	3	0.75	126995
	12.0-4.0	100	12	4	0.75	127000
	18.0-6.0	50	18	6	0.75	127005
	24.0-8.0	50	24	8	1.00	127010
	39.0-13.0	30	39	13	1.15	127015
Lengths Colour: Black						
SR1F3	1.5-0.5	1	1.5	0.5	0.45	144362
	3.0-1.0	1	3	1	0.55	144368
	6.0-2.0	1	6	2	0.65	144378
	9.0-3.0	1	9	3	0.75	144385
	12.0-4.0	1	12	4	0.75	144392
	18.0-6.0	1	18	6	0.75	144399
	24.0-8.0	1	24	8	1.00	144406
	39.0-13.0	1	39	13	1.15	144413
Lengths Colour: Blue						
SR1F3	3.0-1.0	1	3	1	0.55	144371
	6.0-2.0	1	6	2	0.65	144381
	9.0-3.0	1	9	3	0.75	144388
	12.0-4.0	1	12	4	0.75	144395
	18.0-6.0	1	18	6	0.75	144401
	24.0-8.0	1	24	8	1.00	144408
	39.0-13.0	1	39	13	1.15	144415
Lengths Colour: Yellow						
SR1F3	3.0-1.0	1	3	1	0.55	144372
	6.0-2.0	1	6	2	0.65	144382
	9.0-3.0	1	9	3	0.75	144389
	12.0-4.0	1	12	4	0.75	144396
	18.0-6.0	1	18	6	0.75	144402
	24.0-8.0	1	24	8	1.00	144409
	39.0-13.0	1	39	13	1.15	144416

→ Continued on the next page



Heat shrinkable tubes

LOW VOLTAGE
Heat shrink technology

Type	L m	Inner-Ø mm		Recovered wall thickness mm	Art.-No.	
		before shrinking	after shrinking			
Lengths Colour: Red						
SR1F3	1.5-0.5	1,0	1,5	0,5	0,45	144366
	3.0-1.0	1,0	3	1	0,55	144374
	6.0-2.0	1,0	6	2	0,65	144383
	9.0-3.0	1,0	9	3	0,75	144390
	12.0-4.0	1,0	12	4	0,75	144397
	18.0-6.0	1,0	18	6	0,75	144403
	24.0-8.0	1,0	24	8	1,00	144410
	39.0-13.0	1,0	39	13	1,15	144417
Lengths Colour: Green						
SR1F3	1.5-0.5	1,0	1,5	0,5	0,45	204010
	3.0-1.0	1,0	3	1	0,55	204014
	6.0-2.0	1,0	6	2	0,65	154613
	9.0-3.0	1,0	9	3	0,75	204021
	12.0-4.0	1,0	12	4	0,75	204025
	24.0-8.0	1,0	24	8	1,00	204031
	39.0-13.0	1,0	39	13	1,15	144419
	Lengths Colour: White					
SR1F3	1.5-0.5	1,0	1,5	0,5	0,45	144367
	3.0-1.0	1,0	3	1	0,55	144375
	6.0-2.0	1,0	6	2	0,65	144384
	9.0-3.0	1,0	9	3	0,75	144391
	12.0-4.0	1,0	12	4	0,75	144398
	18.0-6.0	1,0	18	6	0,75	144404
	24.0-8.0	1,0	24	8	1,00	144411
	39.0-13.0	1,0	39	13	1,15	144418
Lengths Colour: Grey						
SR1F3	1.5-0.5	1,0	1,5	0,5	0,45	204008
	3.0-1.0	1,0	3	1	0,55	204012
	6.0-2.0	1,0	6	2	0,65	204016
	9.0-3.0	1,0	9	3	0,75	204019
	12.0-4.0	1,0	12	4	0,75	204023
	18.0-6.0	1,0	18	6	0,75	204027
	24.0-8.0	1,0	24	8	1,00	204030
	39.0-13.0	1,0	39	13	1,15	204033
Lengths Colour: Transparent						
SR1F3	1.5-0.5	1	1,5	0,5	0,45	144363
	3.0-1.0	1	3	1	0,55	144369
	6.0-2.0	1	6	2	0,65	144379
	9.0-3.0	1	9	3	0,75	144386
	12.0-4.0	1	12	4	0,75	144393
	18.0-6.0	1	18	6	0,75	144400
	24.0-8.0	1	24	8	1,00	144407
	39.0-13.0	1	39	13	1,15	144414
Lengths Colour: Brown						
SR1F3	3.0-1.0	1	3	1	0,55	204013
	6.0-2.0	1	6	2	0,65	204017
	9.0-3.0	1	9	3	0,75	204020
	12.0-4.0	1	12	4	0,75	204024
	18.0-6.0	1	18	6	0,75	204028
	24.0-8.0	1	24	8	1,00	144412
	39.0-13.0	1	39	13	1,15	204034
Lengths Colour: Green-Yellow						
SR1F3	1.5-0.5	1	1,5	0,5	0,45	204011
	3.0-1.0	1	3	1	0,55	204015
	6.0-2.0	1	6	2	0,65	204018
	9.0-3.0	1	9	3	0,75	204022
	12.0-4.0	1	12	4	0,75	204026
	18.0-6.0	1	18	6	0,75	204029
	24.0-8.0	1	24	8	1,00	204032
	39.0-13.0	1	39	13	1,15	204035



→ Continuation

SR1F3 Heat shrinkable thin wall tube

Technical data	Value	Test standard
Physical properties		
Elongation at break	300 %	ASTM D 638
Tensile strength at break	13 MPa	ASTM D 638
Longitudinal shrinkage	≤ 10 %	ASTM D 2671
Shrink ratio	3:1	IEC 811-1-1
Thermal properties		
Operating temperature range	-55 °C up to 135 °C	IEC 216
Shrinkage temperature	> 90 °C	CPT Test
Burning behaviour	self-extinguishing	UL 224
Flexibility at low temperatures	-55 °C	ASTM-D 2671 C
Electrical properties		
Dielectric strength	20 kV/mm	ASTM D 2671
Specific volume resistivity	10 ¹⁴ Ω x cm	ASTM D 257
Chemical properties		
Corrosion	None	ASTM D 2671 B
Resistance to fungus and decay	No growth	AMS-DTL-7444



SB

Heat shrinkable tube in dispenser box

thin wall, self-extinguishing, shrink ratio 2 : 1, without adhesive

Characteristics

- Back-winding mechanism facilitates rolling up of tube
- User friendly, notch prevents tube from rolling back into the box

Note

- Self-extinguishing (except transparent)
- See „SR1F“ heat shrinkable tube for further information on product properties and technical data

Application/Suitability

- Insulating
- Bundling
- Marking
- Corrosion protection
- Mechanical protection

Material

- Cross-linked polyolefin
- Free of lead and cadmium

Test standards

- Approved according to UL File No.: E 172094
- Corresponds to MIL-I-23053/5 class 1

Storage conditions/Shelf life

- Unlimited shelf life



Colours

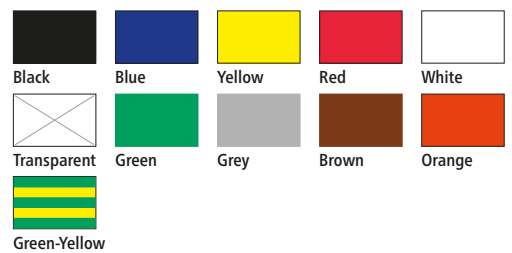

Scope of delivery

Thin wall heat shrinkable tube in dispenser box

Note: A standard spool may include sections which have been tied together.

Type	L m	Inner-Ø inch before shrinking	Inner-Ø mm		Recovered wall thickness mm	Art.-No.
			before shrinking	after shrinking		
Colour: Black						
SB	1.2-0.6	15	3/64	1.2	0.6	127020
	1.6-0.8	15	1/16	1.6	0.8	127027
	2.4-1.2	15	3/32	2.4	1.2	127034
	3.2-1.6	15	1/8	3.2	1.6	127041
	4.8-2.4	10	3/16	4.8	2.4	127049
	6.4-3.2	10	1/4	6.4	3.2	127057
	9.5-4.8	10	3/8	9.5	4.8	127065
	12.7-6.4	8	1/2	12.7	6.4	127073
19.1-9.5	7	3/4	19.1	9.5	127081	
25.4-12.7	4	1	25.4	12.7	127089	
Colour: Blue						
SB	3.2-1.6	15	1/8	3.2	1.6	127044
	4.8-2.4	10	3/16	4.8	2.4	127052
	6.4-3.2	10	1/4	6.4	3.2	127060
	9.5-4.8	10	3/8	9.5	4.8	127068
	12.7-6.4	8	1/2	12.7	6.4	127076
	19.1-9.5	7	3/4	19.1	9.5	127084
	25.4-12.7	4	1	25.4	12.7	127092
Colour: Yellow						
SB	3.2-1.6	15	1/8	3.2	1.6	127045
	4.8-2.4	10	3/16	4.8	2.4	127053
	6.4-3.2	10	1/4	6.4	3.2	127061
	9.5-4.8	10	3/8	9.5	4.8	127069
	12.7-6.4	8	1/2	12.7	6.4	127077
	19.1-9.5	7	3/4	19.1	9.5	127085
	25.4-12.7	4	1	25.4	12.7	127093
Colour: Red						
SB	3.2-1.6	15	1/8	3.2	1.6	127046
	4.8-2.4	10	3/16	4.8	2.4	127054
	6.4-3.2	10	1/4	6.4	3.2	127062
	9.5-4.8	10	3/8	9.5	4.8	127070
	12.7-6.4	8	1/2	12.7	6.4	127078

→ Continued on the next page



Type	L m	Inner-Ø inch before shrinking	Inner-Ø mm		Recovered wall thickness mm	Art.-No.	
			before shrinking	after shrinking			
(Fortsetzung) Farbe: Rot							
SB	19.1-9.5	7	3/4	19,1	9,5	0,76	127086
	25.4-12.7	4	1	25,4	12,7	0,89	127094
Farbe: Weiß							
SB	3.2-1.6	15	1/8	3,2	1,6	0,51	127047
	4.8-2.4	10	3/16	4,8	2,4	0,51	127055
	6.4-3.2	10	1/4	6,4	3,2	0,64	127063
	9.5-4.8	10	3/8	9,5	4,8	0,64	127071
	12.7-6.4	8	1/2	12,7	6,4	0,64	127079
	19.1-9.5	7	3/4	19,1	9,5	0,76	127087
	25.4-12.7	4	1	25,4	12,7	0,89	127095
Farbe: Transparent							
SB	1.2-0.6	15	3/64	1,2	0,6	0,41	127021
	3.2-1.6	15	1/8	3,2	1,6	0,51	127043
	4.8-2.4	10	3/16	4,8	2,4	0,51	127051
	6.4-3.2	10	1/4	6,4	3,2	0,64	127059
	9.5-4.8	10	3/8	9,5	4,8	0,64	127067
	12.7-6.4	8	1/2	12,7	6,4	0,64	127075
	19.1-9.5	7	3/4	19,1	9,5	0,76	127083
25.4-12.7	4	1	25,4	12,7	0,89	127091	
Farbe: Grün							
SB	3.2-1.6	15	1/8	3,2	1,6	0,51	127048
	4.8-2.4	10	3/16	4,8	2,4	0,51	127056
	6.4-3.2	10	1/4	6,4	3,2	0,64	127064
	9.5-4.8	10	3/8	9,5	4,8	0,64	127072
	12.7-6.4	8	1/2	12,7	6,4	0,64	127080
	19.1-9.5	7	3/4	19,1	9,5	0,76	127088
	25.4-12.7	4	1	25,4	12,7	0,89	127096
Farbe: Grau							
SB	3.2-1.6	15	1/8	3,2	1,6	0,51	144429
	4.8-2.4	10	3/16	4,8	2,4	0,51	144433
	6.4-3.2	10	1/4	6,4	3,2	0,64	144438
	9.5-4.8	10	3/8	9,5	4,8	0,64	144444
	12.7-6.4	8	1/2	12,7	6,4	0,64	144449
	19.1-9.5	7	3/4	19,1	9,5	0,76	144455
	25.4-12.7	4	1	25,4	12,7	0,89	144460
Farbe: Braun							
SB	3.2-1.6	15	1/8	3,2	1,6	0,51	144430
	4.8-2.4	10	3/16	4,8	2,4	0,51	144434
	6.4-3.2	10	1/4	6,4	3,2	0,64	144439
	9.5-4.8	10	3/8	9,5	4,8	0,64	144445
	12.7-6.4	8	1/2	12,7	6,4	0,64	144450
	19.1-9.5	7	3/4	19,1	9,5	0,76	144456
	25.4-12.7	4	1	25,4	12,7	0,89	144461
Farbe: Orange							
SB	3.2-1.6	15	1/8	3,2	1,6	0,51	144426
	4.8-2.4	10	3/16	4,8	2,4	0,51	144431
	9.5-4.8	10	3/8	9,5	4,8	0,64	144440
	12.7-6.4	8	1/2	12,7	6,4	0,64	144446
	19.1-9.5	7	3/4	19,1	9,5	0,76	144451
	25.4-12.7	4	1	25,4	12,7	0,89	144457
Farbe: Grün-Gelb							
SB	3.2-1.6	15	1/8	3,2	1,6	0,51	127042
	4.8-2.4	10	3/16	4,8	2,4	0,51	127050
	6.4-3.2	10	1/4	6,4	3,2	0,64	127058
	9.5-4.8	10	3/8	9,5	4,8	0,64	127066
	12.7-6.4	8	1/2	12,7	6,4	0,64	127074
	19.1-9.5	7	3/4	19,1	9,5	0,76	127082
	25.4-12.7	4	1	25,4	12,7	0,89	127090



SB

Heat shrinkable tube in dispenser box

thin wall, self-extinguishing, shrink ratio 3 : 1, without adhesive

Characteristics

- Back-winding mechanism facilitates rolling up of tube
- User friendly, notch prevents tube from rolling back into the box
- Self-extinguishing (except transparent)

Note

- See „SR1F3“ heat shrinkable tube for further information on product properties and technical data

Application/Suitability

- Insulating
- Bundling
- Marking
- Corrosion protection
- Mechanical protection

Material

- Cross-linked polyolefin
- Free of lead and cadmium

Test standards

- Approved according to UL File No.: E 172094
- Corresponds to MIL-I-23053/5 class 1

Storage conditions/Shelf life

- Unlimited shelf life



Colours

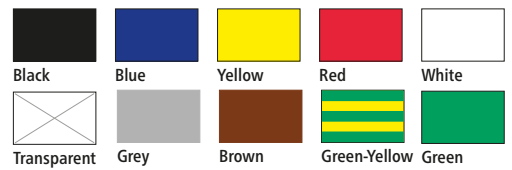

Scope of delivery

Thin wall heat shrinkable tube in dispenser box

Note: A standard spool may include sections which have been tied together.

Type	L m	Inner-Ø mm		Recovered wall thickness mm	Art.-No.
		before shrinking	after shrinking		
Colour: Black					
SB	1.5-0.5	15	1.5	0.5	127097
	3.0-1.0	15	3	1	127104
	6.0-2.0	10	6	2	127111
	9.0-3.0	10	9	3	127118
	12.0-4.0	8	12	4	127125
	18.0-6.0	7	18	6	127132
	24.0-8.0	4	24	8	127139
Colour: Blue					
SB	1.5-0.5	15	1.5	0.5	127099
	3.0-1.0	15	3	1	127106
	6.0-2.0	10	6	2	127113
	9.0-3.0	10	9	3	127120
	12.0-4.0	8	12	4	127127
	18.0-6.0	7	18	6	127134
	24.0-8.0	4	24	8	127141
Colour: Yellow					
SB	1.5-0.5	15	1.5	0.5	127100
	3.0-1.0	15	3	1	127107
	6.0-2.0	10	6	2	127114
	9.0-3.0	10	9	3	127121
	12.0-4.0	8	12	4	127128
	18.0-6.0	7	18	6	127135
	24.0-8.0	4	24	8	127142
Colour: Red					
SB	1.5-0.5	15	1.5	0.5	127101
	3.0-1.0	15	3	1	127108
	6.0-2.0	10	6	2	127115
	9.0-3.0	10	9	3	127122
	12.0-4.0	8	12	4	127129
	18.0-6.0	7	18	6	127136
	24.0-8.0	4	24	8	127143
Colour: White					
SB	1.5-0.5	15	1.5	0.5	127102
	3.0-1.0	15	3	1	127109

→ Continued on the next page



Type	L m	Inner-Ø mm		Recovered wall thickness mm	Art.-No.	
		before shrinking	after shrinking			
(Continuation) Colour: White						
SB	6.0-2.0	10	6	2	0.65	127116
	9.0-3.0	10	9	3	0.75	127123
	12.0-4.0	8	12	4	0.75	127130
	18.0-6.0	7	18	6	0.75	127137
	24.0-8.0	4	24	8	1.00	127144
Colour: Transparent						
SB	1.5-0.5	15	1.5	0.5	0.45	127098
	3.0-1.0	15	3	1	0.55	144462
	6.0-2.0	10	6	2	0.65	127112
	9.0-3.0	10	9	3	0.75	127119
	12.0-4.0	8	12	4	0.75	127126
	18.0-6.0	7	18	6	0.75	127133
	24.0-8.0	4	24	8	1.00	127140
Farbe: Grün						
SB	1.5-0.5	15	1,5	0,5	0,45	200294
	3.0-1.0	15	3	1	0,55	127110
	6.0-2.0	10	6	2	0,65	127117
	9.0-3.0	10	9	3	0,75	200295
	12.0-4.0	8	12	4	0,75	127131
	18.0-6.0	7	18	6	0,75	127131
	24.0-8.0	4	24	8	1,00	127145
Colour: Grey						
SB	1.5-0.5	15	1.5	0.5	0.45	203674
	3.0-1.0	15	3	1	0.55	203675
	6.0-2.0	10	6	2	0.65	203676
	9.0-3.0	10	9	3	0.75	203677
	12.0-4.0	8	12	4	0.75	203678
	18.0-6.0	7	18	6	0.75	203679
	24.0-8.0	4	24	8	1.00	203680
Colour: Brown						
SB	3.0-1.0	15	3	1	0.55	203787
	6.0-2.0	10	6	2	0.65	203788
	9.0-3.0	10	9	3	0.75	203789
	12.0-4.0	8	12	4	0.75	203790
	18.0-6.0	7	18	6	0.75	203791
	24.0-8.0	4	24	8	1.00	203792
Colour: Green-Yellow						
SB	1.5-0.5	15	1.5	0.5	0.45	204297
	3.0-1.0	15	3	1	0.55	204298
	6.0-2.0	10	6	2	0.65	204299
	9.0-3.0	10	9	3	0.75	204310
	12.0-4.0	8	12	4	0.75	204311
	18.0-6.0	7	18	6	0.75	204312
	24.0-8.0	4	24	8	1.00	204313



MBS1 Assortment box

with thin wall heat shrinkable tubes and cable ties

Characteristics

- Practice-oriented product assortment

Note

- See „SR1F“ and „SRC1“ heat shrinkable tubes and „KS“ cable ties for further information on product properties and technical data

Application/Suitability

- For marking and insulation of cables and conductors
- Corrosion protection
- Mechanical protection

Test standards

- Approved according to UL File No.: E 172094
- Corresponds to MIL-I-23053/5 class 1

Storage conditions/Shelf life

- Unlimited shelf life



Scope of delivery

Assortment box, cable ties, heat shrinkable tubes in various dimensions, lengths and colours

Heat shrinkable tubes				
SR1F	1.6-0.8	Red	30 mm	50 pieces
	2.4-1.2	Red	50 mm	10 pieces
	3.2-1.6	Yellow	30 mm	30 pieces
	3.2-1.6	Transparent	50 mm	40 pieces
	4.8-2.4	Yellow	100 mm	10 pieces
	4.8-2.4	Transparent	100 mm	10 pieces
	4.8-2.4	Blue	50 mm	25 pieces
	4.8-2.4	Red	50 mm	25 pieces
	6.4-3.2	Red	100 mm	10 pieces
	6.4-3.2	Blue	100 mm	10 pieces
	6.4-3.2	White	50 mm	10 pieces
	6.4-3.2	Transparent	50 mm	10 pieces
SRC1	2.4-1.2	Black	50 mm	30 pieces
	9.5-4.8	Black	50 mm	10 pieces
	12.7-6.4	Black	100 mm	5 pieces
	12.7-6.4	Black	150 mm	5 pieces
	19.1-9.5	Black	100 mm	5 pieces
	19.1-9.5	Black	200 mm	5 pieces
	25.4-12.7	Black	250 mm	3 pieces
Cable ties				
KS	3.6-140	Black	140 mm	100 pieces

Type	Art.-No.
MBS1	144420



MMK Mini joint case

with medium wall heat shrinkable tubes and heat shrinkable crimp connectors, for joints up to 2.5 mm²

Characteristics

- Practical multi-purpose case with adjustable compartments, containing heat shrinkable tubes and heat shrinkable crimp connectors

Application/Suitability

- Fast-assembly kit for up to 16 straight-through joints ranging between 0.5 and 2.5 mm²

Note

- See „SRUM“ heat shrinkable tube and „DR“ heat shrinkable crimp connectors for further information on product properties and technical data



Scope of delivery

Multi-purpose case, heat shrinkable tubes and heat shrinkable crimp connectors in various dimensions, lengths and colours

Heat shrinkable tubes				
SRUM	18-6	Black	160 mm	10 pieces
	24-8	Black	160 mm	6 pieces
Heat shrinkable crimp connectors				
DR	1	Red		20 pieces
	2	Blue		30 pieces

Type	Art.-No.
MMK	193442



SRUM Heat shrinkable medium wall tube

self-extinguishing, flexible, shrink ratio 3 : 1 or 4 : 1, with adhesive

Characteristics

- Medium wall
- Inscrutable
- Resistant to chemical agents
- Stabilized against UV rays
- Free from paint-wetting inhibiting substances
- Non-corrosive
- Infusible
- High flexibility
- Superior electrical properties
- High tensile strength
- Resistant to cold flow (thermally stable)
- Self-extinguishing

Application/Suitability

- Insulating
- Bundling
- Corrosion protection
- Mechanical protection

Material

- Cross-linked polyolefin
- Free of lead and cadmium

Test standards

- Corresponds to MIL-I-23053/4

Storage conditions/Shelf life

- Unlimited shelf life



Colours



Black

Scope of delivery

Medium wall heat shrinkable tube, on spool or in lengths

Note: A standard spool may include sections which have been tied together. Other lengths available on request.

Type	L m	Inner-Ø mm		Recovered wall thickness mm	Art.-No.	
		before shrinking	after shrinking			
Shrink ratio 3:1						
Spool Colour: Black						
SRUM	3-1	300	3	1	1.4	127471
	6-2	300	6	2	1.7	127472
	9-3	150	9	3	1.9	127473
	12-4	100	12	4	2.3	127474
	18-6	50	18	6	2.7	127475
	24-8	50	24	8	3.1	127476
	39-13	30	39	13	3.1	127477
Lengths Colour: Black						
SRUM	3-1	1	3	1	1.4	148840
	6-2	1	6	2	1.7	149433
	9-3	1	9	3	1.9	152008
	12-4	1	12	4	2.3	148842
	18-6	1	18	6	2.7	150148
	24-8	1	24	8	3.1	150278
	39-13	1	39	13	3.1	150149
Shrink ratio 4:1						
Spool Colour: Black						
SRUM	4-1	300	4	1	1,4	145064
	8-2	150	8	2	1.7	145065
	16-4	100	16	4	2.3	145069
	24-6	50	24	6	2.7	145071
	32-8	30	32	8	3.1	145073
	52-13	30	52	13	3.1	145075
Lengths Colour: Black						
SRUM	4-1	1	4	1	1.4	240160
	8-2	1	8	2	1.7	240163
	16-4	1	16	4	2.3	240167
	24-6	1	24	6	2.7	240168
	32-8	1	32	8	3.1	240170
	52-13	1	52	13	3.1	155962

→ Continued on the next page



→ Continuation

SRUM Heat shrinkable medium wall tube

Technical data	Value	Test standard
Physical properties		
Elongation at break	300 %	ASTM D 638
Tensile strength at break	11 MPa	ASTM D 638
Longitudinal shrinkage	≤ 15 %	ASTM D 2671
Thermal properties		
Operating temperature range	-55 °C up to 110 °C	IEC 216
Shrinkage temperature	> 110 °C	
Burning behaviour	self-extinguishing	UL 224
Flexibility at low temperatures	-55 °C up to + 110 °C	ASTM-D 2671 C
Electrical properties		
Dielectric strength	15 kV/mm	ASTM D 2671
Specific volume resistivity	10 ¹⁴ Ω x cm	ASTM D 257
Chemical properties		
Corrosion	None	ASTM D 2671 B
Resistance to fungus and decay	No growth	AMS-DTL-7444

**SR2, SRH2****Heat shrinkable medium wall tube**

halogen-free, shrink ratio 3 : 1, with or without adhesive

Characteristics

- Medium wall
- Inscrutable
- Resistant to chemical agents
- Stabilized against UV rays (Colour: Black)
- Free from paint-wetting inhibiting substances
- Halogen-free
- Non-corrosive
- Infusible
- Superior electrical properties
- High tensile strength
- Resistant to cold flow (thermally stable)

Application/Suitability

- Insulating
- Protection against moisture and pressure
- Suitable for heat shrinkable joints and terminations

Material

- Cross-linked polyolefin
- Free of lead and cadmium

Test standards

- Corresponds to IEC 60684-2

Storage conditions/Shelf life

- Unlimited shelf life

**Colours**

Black



Green-Yellow

Scope of delivery

Medium wall heat shrinkable tube, on spool or in lengths

Note: A standard spool may include sections which have been tied together. Other lengths available on request.

Type	L m	Inner-Ø mm		Recovered wall thickness mm	Art.-No.	
		before shrinking	after shrinking			
without adhesive						
Spool Colour: Black						
SR2	12-3	30	12	3	2.2	143759
	22-6	30	22	6	2.6	143764
	34-7	30	34	7	2.6	143766
	40-12	30	40	12	2.6	143770
	56-16	30	56	16	2.7	143803
Spool Colour: Green-Yellow						
SR2	12-4	5	12	4	1.5	127383
	12-4	25	12	4	1.5	127384
	27-9	5	27	9	1.5	127386
	27-9	25	27	9	1.5	127387
Lengths Colour: Black						
SR2	12-3	1	12	3	2.2	127391
	22-6	1	22	6	2.6	127394
	34-7	1	34	7	2.6	127397
	40-12	1	40	12	2.6	127400
	56-16	1	56	16	2.7	127403
	63-19	1	63	19	2.8	143818
	75-22	1	75	22	3	127406
	95-26	1	95	26	3.2	127407
	120-34	1	120	34	3.3	127408
	140-42	1	140	42	3.5	143806
	160-50	1	160	50	3.5	143811
with adhesive						
Lengths Colour: Black						
SRH2	8-2	1	8	2	1.7	127416
	12-3	1	12	3	2.2	127417
	22-6	1	22	6	2.6	127418
	34-7	1	34	7	2.6	127421
	40-12	1	40	12	2.6	127423
	56-16	1	56	16	2.7	127425
	63-19	1	63	19	2.8	135859
	75-22	1	75	22	3	127427
	95-26	1	95	26	3.2	127429
	120-34	1	120	34	3.3	127431
	140-42	1	140	42	3.5	144013
	160-50	1	160	50	3.5	144018

→ Continued on the next page



→ Continuation

SR2, SRH2 Heat shrinkable medium wall tube

Technical data	Value	Test standard
Physical properties		
Hardness	55 Shore D	DIN 53 505
Elongation at break	350 %	IEC 60684-2
Tensile strength at break	13 MPa	IEC 60684-2
Longitudinal shrinkage	≤ 10 %	IEC 60684-2
Shrink ratio	3:1	IEC 60684-2
Eccentricity expanded	50 %	IEC 60684-2
recovered	85 %	
Thermal properties		
Operating temperature range	-40 °C up to 120 °C	IEC 60684-2
Shrinkage temperature	> 125 °C	
Burning behaviour	not self-extinguishing	IEC 60684-2 method C
Flexibility at low temperatures	-40 °C	IEC 60684-2
Thermal ageing (168 h at 150 °C)		
Elongation at break	250 %	IEC 60684-2
Tensile strength at break	12 MPa	
Electrical properties		
Dielectric strength	25 kV/mm	IEC 60684-2
Specific volume resistivity	10 ¹⁴ Ω x cm	IEC 60684-2
Chemical properties		
Corrosion	None	IEC 60684-2
Resistance to fungus and decay	Rate 1	IEC 60684-2



SRFH2

Heat shrinkable medium wall tube

self-extinguishing, shrink ratio 3 : 1, with adhesive

Characteristics

- Medium wall
- Inscrutable
- Resistant to chemical agents
- Stabilized against UV rays
- Free from paint-wetting inhibiting substances
- Non-corrosive
- Infusible
- Superior electrical properties
- High tensile strength
- Resistant to cold flow (thermally stable)
- Self-extinguishing

Application/Suitability

- Insulating
- Protection against moisture and pressure
- Suitable for heat shrinkable joints and terminations

Material

- Cross-linked polyolefin
- Free of lead and cadmium

Test standards

- Corresponds to IEC 60684-2

Storage conditions/Shelf life

- Unlimited shelf life



Colours



Black

Scope of delivery

Medium wall heat shrinkable tube in lengths

Note: Other lengths available on request.

Type	L m	Inner-Ø mm		Recovered wall thickness mm	Art.-No.	
		before shrinking	after shrinking			
Lengths Colour: Black						
SRFH2	12-4	1	12	4	2.6	144493
	21-7	1	21	7	2.6	144498

Technical data	Value	Test standard
Physical properties		
Hardness	51 Shore D	DIN 53 505
Elongation at break	350 %	IEC 60684-2
Tensile strength at break	13 MPa	IEC 60684-2
Longitudinal shrinkage	≤ 10 %	IEC 60684-2
Shrink ratio	3:1	IEC 60684-2
Eccentricity expanded recovered	50 % 85 %	IEC 60684-2
Thermal properties		
Operating temperature range	-40 °C up to 120 °C	IEC 60684-2
Shrinkage temperature	> 125 °C	
Burning behaviour	self-extinguishing	IEC 60684-2 method C
Flexibility at low temperatures	-40 °C	IEC 60684-2
Thermal ageing (168 h at 150 °C)		
Elongation at break	250 %	
Tensile strength at break	12 MPa	IEC 60684-2
Electrical properties		
Dielectric strength	25 kV/mm	IEC 60684-2
Specific volume resistivity	10 ¹⁴ Ω x cm	IEC 60684-2
Chemical properties		
Corrosion	None	IEC 60684-2
Resistance to fungus and decay	Rate 1	IEC 60684-2



SR3, SRH3

Heat shrinkable thick wall tube

halogen-free, shrink ratio 3 : 1, with or without adhesive

Characteristics

- Thick wall
- Inscrutable
- Resistant to chemical agents
- Stabilized against UV rays
- Free from paint-wetting inhibiting substances
- Halogen-free
- Non-corrosive
- Infusible
- Superior electrical properties
- High tensile strength
- Resistant to cold flow (thermally stable)

Application/Suitability

- Insulating
- Protection against moisture and pressure
- Suitable for heat shrinkable joints and terminations

Material

- Cross-linked polyolefin
- Free of lead and cadmium

Test standards

- Corresponds to IEC 60684-2

Storage conditions/Shelf life

- Unlimited shelf life



Colours



Black

Scope of delivery

Thick wall heat shrinkable tube in lengths

Note: Other lengths available on request.

Type	L m	Inner-Ø mm		Recovered wall thickness mm	Art.-No.	
		before shrinking	after shrinking			
without adhesive						
Lengths Colour: Black						
SR3	22-6	1	22	6	2.7	127488
	33-8	1	33	8	4	144613
	45-12	1	45	12	4.4	127490
	55-15	1	55	15	4.4	144620
	75-20	1	75	20	4.5	144596
	92-25	1	92	25	4.7	127493
with adhesive						
Lengths Colour: Black						
SRH3	12-3	1	12	3	2,6	127503
	16-4	1	16	4	2,8	135860
	22-5	1	22	5	2,9	443960
	33-8	1	33	8	4	127507
	48-12	1	45	12	4,5	443980
	63-15	1	48	15	4,5	444005
	75-20	1	63	20	4,4	127522
	92-25	1	92	25	4,6	127515
	130-34	1	130	34	4,8	144863
	160-50	1	160	50	4,8	158903

→ Continued on the next page



→ Continuation

SR3, SRH3 Heat shrinkable thick wall tube

Technical data	Value	Test standard
Physical properties		
Hardness	55 Shore D	DIN 53 505
Elongation at break	350 %	IEC 60684-2
Tensile strength at break	13 MPa	IEC 60684-2
Longitudinal shrinkage	≤ 10 %	IEC 60684-2
Shrink ratio	3:1	IEC 60684-2
Eccentricity expanded	50 %	
recovered	85 %	IEC 60684-2
Thermal properties		
Operating temperature range	-40 °C up to 120 °C	IEC 60684-2
Shrinkage temperature	> 125 °C	
Burning behaviour	not self-extinguishing	IEC 60684-2 method C
Flexibility at low temperatures	-40 °C	IEC 60684-2
Thermal ageing (168 h at 150 °C)		
Elongation at break	250 %	
Tensile strength at break	12 MPa	IEC 60684-2
Electrical properties		
Dielectric strength	25 kV/mm	IEC 60684-2
Specific volume resistivity	10 ¹⁴ Ω x cm	IEC 60684-2
Chemical properties		
Corrosion	None	IEC 60684-2
Resistance to fungus and decay	Rate 1	IEC 60684-2



SRFH3

Heat shrinkable thick wall tube

self-extinguishing, shrink ratio 3 : 1, with adhesive

Characteristics

- Thick wall
- Inscrutable
- Resistant to chemical agents
- Stabilized against UV rays
- Free from paint-wetting inhibiting substances
- Non-corrosive
- Infusible
- Superior electrical properties
- High tensile strength
- Resistant to cold flow (thermally stable)
- Self-extinguishing

Application/Suitability

- Insulating
- Protection against moisture and pressure
- Suitable for heat shrinkable joints and terminations

Material

- Cross-linked polyolefin
- Free of lead and cadmium

Test standards

- Corresponds to IEC 60684-2

Storage conditions/Shelf life

- Unlimited shelf life



Colours



Black

Scope of delivery

Thick wall heat shrinkable tube in lengths

Note: Other lengths available on request.

Type	L m	Inner-Ø mm		Recovered wall thickness mm	Art.-No.	
		before shrinking	after shrinking			
Lengths Colour: Black						
SRFH3	30-8	1	30	8	3.5	144527
	40-13	1	40	13	3.5	144536
	55-18	1	55	18	3.8	144545
	80-26	1	80	26	3.8	144559

Technical data	Value	Test standard
Physical properties		
Hardness	51 Shore D	DIN 53 505
Elongation at break	350 %	IEC 60684-2
Tensile strength at break	13 MPa	IEC 60684-2
Longitudinal shrinkage	≤ 10 %	IEC 60684-2
Shrink ratio	3:1	IEC 60684-2
Eccentricity expanded recovered	50 % 85 %	IEC 60684-2
Thermal properties		
Operating temperature range	-40 °C up to 120 °C	IEC 60684-2
Shrinkage temperature	> 125 °C	
Burning behaviour	self-extinguishing	IEC 60684-2 method C
Flexibility at low temperatures	-40 °C	IEC 60684-2
Thermal ageing (168 h at 150 °C)		
Elongation at break	250 %	
Tensile strength at break	12 MPa	IEC 60684-2
Electrical properties		
Dielectric strength	25 kV/mm	IEC 60684-2
Specific volume resistivity	10 ¹⁴ Ω x cm	IEC 60684-2
Chemical properties		
Corrosion	None	IEC 60684-2
Resistance to fungus and decay	Rate 1	IEC 60684-2



SRBK-Set

Heat shrinkable thick wall tube

anti-slip, halogen-free, shrink ratio 3 : 1, with adhesive

Protection and mechanical connection of telecommunication cable plug-in systems.

Characteristics

- Thick wall
- Resistant to chemical agents
- Stabilized against UV rays
- Free from paint-wetting inhibiting substances
- Halogen-free
- Non-corrosive
- Infusible
- Superior electrical properties
- Excellent adhesion to all cable materials
- High tensile strength
- Resistant to cold flow (thermally stable)

Application/Suitability

- Telecommunications terminal block system

Material

- Cross-linked polyolefin
- Free of lead and cadmium

Test standards

- Corresponds to IEC 60684-2

Storage conditions/Shelf life

- Unlimited shelf life



Colours



Black

Scope of delivery

10 thick wall heat shrinkable tubes in lengths, 20 fire protection wrapping, 10 cleaning tissues, 10 emery cloths

Type		L mm	Inner-Ø mm		Recovered wall thickness mm	Art.-No.
			before shrinking	after shrinking		
SRBK-Set	25-7	170	25	7	3.1	146123
	32-8	210	32	8	3.2	146124

Technical data	Value	Test standard
Physical properties		
Hardness	50 Shore D	DIN 53 505
Elongation at break	350 %	IEC 60684-2
Tensile strength at break	13 MPa	IEC 60684-2
Longitudinal shrinkage	≤ 10 %	IEC 60684-2
Shrink ratio	3:1	IEC 60684-2
Eccentricity expanded recovered	50 % 85 %	IEC 60684-2
Thermal properties		
Operating temperature range	-40 °C up to 120 °C	IEC 60684-2
Shrinkage temperature	> 125 °C	
Burning behaviour	self-extinguishing	IEC 60684-2 method C
Flexibility at low temperatures	-40 °C	IEC 60684-2
Thermal ageing (168 h at 150 °C)		
Elongation at break	350 %	
Tensile strength at break	13 MPa	IEC 60684-2
Electrical properties		
Dielectric strength	20 kV/mm	IEC 60684-2
Specific volume resistivity	10 ¹⁴ Ω x cm	IEC 60684-2
Chemical properties		
Corrosion	None	IEC 60684-2
Resistance to fungus and decay	Rate 1	IEC 60684-2



SKH Heat shrinkable end cap

with hot-melt adhesive

Protection against humidity and pressure for cables, conductors and pipes with a diameter of 5 - 105 mm.

Characteristics

- Compliant to REACH and RohS
- Stabilized against UV irradiation by carbon black content $\geq 2.5\%$
- Free from Silicones and other paint-wetting inhibiting substances
- Coated inside with high-quality hot-melt adhesive.
- Superior electrical properties
- High mechanical strength
- Resistant to chemical agents as defined in IEC 62677-2: Insulating oil mineral, Isopropylalcohol, deionized water

Application/Suitability

- Protection against moisture and pressure for cables, conductors and pipes

Note

- Length tolerance max. $\pm 10\%$ in fully recovered condition

Material

- Cross-linked polyolefin

Test standards

- Based on: IEC 62677-3-101

Storage conditions/Shelf life

- Unlimited shelf life



Colours



Black

Dimensions

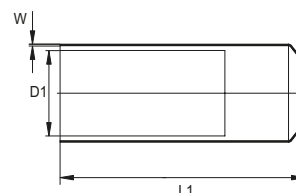

Scope of delivery

Heat shrinkable end cap

Type	L1 mm	L1* mm	Inner-Ø D1 mm		W* Recovered wall thickness mm	Art.-No.	
			before shrinking	after shrinking			
with adhesive							
SKH	10-4	46	45	10	4	2,9	125345
	15-5	47	43	15	5	2,2	125351
	22-9	76	65	22	9	2.8	125334
	35-15	111	103	35	15	3.2	125335
	55-25	165	155	55	25	3.5	125336
	75-30	181	148	75	30	4.4	125337
	95-40	215	183	95	40	3.8	125338
	100-45	176	156	100	45	4.1	368748

*recovered dimension after shrinking

Technical data	Value	Test standard
Physical properties		
Elongation at break	min. 300 %	EN 62677-2 or EN ISO 527-2
Tensile strength at break	min. 10 MPa	EN 62677-2 or EN ISO 527-2
Thermal properties		
Operating temperature range	-40 °C up to 100 °C	EN 62677-2
Shrinkage temperature	> 110 °C	
Burning behaviour	not self-extinguishing	
Flexibility at low temperatures	-40 °C	EN 62677-2
Thermal ageing (168 h at 150 °C)		
Elongation at break	min. 200 %	EN 62677-2 or EN ISO 527-2
Tensile strength at break	min. 8 MPa	
Electrical properties		
Dielectric strength	min. 10 kV/mm	EN 60243-1
Specific volume resistivity	min. $10^{13} \Omega \times \text{cm}$	EN 62677-2



SEH

Heat shrinkable spreader cap

for 2-, 3-, 4-, 5-core cables and conductors, with hot-melt adhesive

Sealing spreader caps for plastic-, rubber- and paper-insulated cables.

Characteristics

- Compliant to REACH and RohS
- Stabilized against UV irradiation by carbon black content $\geq 2.5\%$
- Free from Silicones and other paint-wetting inhibiting substances
- Coated inside with high-quality hot-melt adhesive.
- Superior electrical properties
- High mechanical strength
- Resistant to chemical agents as defined in IEC 62677-2: Insulating oil mineral, Isopropylalcohol, deionized water

Application/Suitability

- Protection against moisture and pressure for cables, conductors and pipes

Note

- Length tolerance max. $\pm 10\%$ in fully recovered condition

Material

- Cross-linked polyolefin

Test standards

- Based on: IEC 62677-3-101

Storage conditions/Shelf life

- Unlimited shelf life



Colours



Black

Dimensions

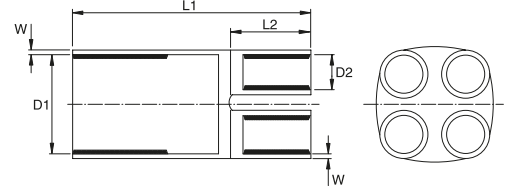

Scope of delivery

Heat shrinkable spreader cap

Type	L1 mm	L1* mm	L2 mm	Inner-Ø D1 mm		Inner-Ø D2 mm		W* Recovered wall thickness mm	Nominal cross section mm ²	Art.-No.
				before shrinking	after shrinking	before shrinking	after shrinking			
2-fingers spreader cap										
SEH2	30-10	67	89	17	30	10	16	3.1	2.5 - 25	125374
	50-24	86	120	24	50	24	21	3	25 - 120	169475
	60-20	103	130	33	60	20	45 / 32	18 / 6	95 - 150	125373
3-fingers spreader cap										
SEH3	25-9	52	70	16	25	9	9	2.5	1.5 - 16	169471
	35-15	87	100	22	35	15	13	2.5	6 - 35	125365
	55-23	134	170	33	55	23	24	3.9	35 - 150	169473
	75-28	175	212	36	75	28	35	4	120 - 300	186615
	110-35	182	218	45	110	35	51	17	185 - 400	169711
	125-59	208	268	51	125	59	67	27	240 - 500	125371
4-fingers spreader cap										
SEH4	28-9	57	72	16	28	9	8	2.5	1.5 - 10	148844
	35-15	81	100	22	35	15	14	3.9	6 - 35	143556
	47-23	134	169	36	47	23	20	4.1	35 - 95	166973
	60-25	155	177	32	60	25	25	3.9	35 - 150	169477
	78-36	172	220	43	78	36	30	3.8	95 - 240	166972
	95-36	172	221	50	95	36	35	3.9	120 - 300	143563
	150-55	190	245	47	150	55	57	4.2	240 - 500	302333
5-fingers spreader cap										
SEH5	65-15	84	108	22	65	15	20	4.4	4 - 70	222242
	80-33	160	179	49	80	33	27	3.4	35 - 150	223131
	100-42	170	198	52	100	42	34	3.6	95 - 240	223132

*recovered dimension after shrinking

→ Continued on the next page



→ Continuation

SEH Heat shrinkable spreader cap

Technical data	Value	Test standard
Physical properties		
Elongation at break	min. 300 %	EN 62677-2 or EN ISO 527-2
Tensile strength at break	min. 10 MPa	EN 62677-2 or EN ISO 527-2
Thermal properties		
Operating temperature range	-40 °C up to 100 °C	EN EN 62677-2
Shrinkage temperature	> 110 °C	
Burning behaviour	not self-extinguishing	
Flexibility at low temperatures	-40 °C	EN 62677-2
Thermal ageing (168 h at 150 °C)		
Elongation at break	min. 200 %	
Tensile strength at break	min. 8 MPa	EN 62677-2 or EN ISO 527-2
Electrical properties		
Dielectric strength	min. 10 kV/mm	EN 60243-1
Specific volume resistivity	min. 10 ¹³ Ω x cm	EN 62677-2



SRMAHV

Heat shrinkable repair sleeve

with adhesive and stainless steel channel

For repairing damaged sheaths of all polymeric- and rubber-insulated cables and conductors.

Characteristics

- Medium wall
- Resistant to chemical agents
- Stabilized against UV rays
- Free from paint-wetting inhibiting substances
- Halogen-free
- Non-corrosive
- Infusible
- Maximum inner pressure: 1.5 bar
- Superior electrical properties
- High tensile strength
- Resistant to cold flow (thermally stable)

Application/Suitability

- Sealing
- Repair of damaged cable sheaths

Material

- Cross-linked polyolefin
- Free of lead and cadmium

Test standards

- Corresponds to IEC 60684-2

Storage conditions/Shelf life

- Unlimited shelf life



Colours



Black

Scope of delivery

Heat shrinkable repair sleeve, stainless steel channel, assembly instructions

Type	Inner-Ø mm		Application range mm		Recovered wall thickness mm	Art.-No.
	before shrinking	after shrinking	min. shrinking	max. shrinking		
SRMAHV	28-10 / 250	32	10	28	2.3	143595
	28-10 / 500	32	10	28	2.3	143601
	28-10 / 750	32	10	28	2.3	143605
	28-10 / 1000	32	10	28	2.3	143592
	43-12 / 250	52	12	43	3.4	165912
	43-12 / 500	52	12	43	3.4	166012
	43-12 / 750	52	12	43	3.4	166013
	43-12 / 1000	52	12	43	3.4	166016
	43-12 / 1500	52	12	43	3.4	143627
	72-18 / 250	82	18	72	3.4	143630
	72-18 / 500	82	18	72	3.4	143632
	72-18 / 750	82	18	72	3.4	143637
	72-18 / 1000	82	18	72	3.4	143628
	72-18 / 1500	82	18	72	3.4	143646
	72-18 / 2000	82	18	72	3.4	143629
	93-26 / 250	105	26	93	3.4	143649
	93-26 / 500	105	26	93	3.4	143650
	93-26 / 750	105	26	93	3.4	143654
	93-26 / 1000	105	26	93	3.4	143647
	93-26 / 2000	105	26	93	3.4	143648
	115-30 / 250	130	30	115	2.3	143661
	115-30 / 500	130	30	115	2.3	143663
	115-30 / 750	130	30	115	2.3	143665
	115-30 / 1000	130	30	115	2.3	143659
	115-30 / 1500	130	30	115	2.3	143669
	125-32 / 500	143	32	125	2.3	143672
	125-32 / 750	143	32	125	2.3	143673
	125-32 / 1000	143	32	125	2.3	143670
	125-32 / 1500	143	32	125	2.3	143679
	198-50 / 1000	220	50	198	2.3	143680

→ Continued on the next page







→ Continuation

SRMAHV Heat shrinkable repair sleeve

Technical data	Value	Test standard
Physical properties		
Hardness	50 Shore D	IEC 60684-2
Elongation at break	300 %	IEC 60684-2
Tensile strength at break	13 MPa	IEC 60684-2
Longitudinal shrinkage	≤ 10 %	IEC 60684-2
Shrink ratio	> 3:1	IEC 60684-2
Thermal properties		
Operating temperature range	-40 °C up to 120 °C	IEC 60684-2
Shrinkage temperature	> 125 °C	
Flexibility at low temperatures	-40 °C	IEC 60684-2
Thermal ageing (168 h at 150 °C)		
Tensile strength at break	12 MPa	IEC 60684-2
Electrical properties		
Dielectric strength	12 kV/mm	IEC 60684-2
Specific volume resistivity	10 ¹⁵ Ω x cm	IEC 60684-2
Dielectric constant	5.0	IEC 60684-2
Chemical properties		
Corrosion	None	IEC 60684-2
Resistance to fungus and decay	Rate 1	IEC 60684-2

LOW VOLTAGE

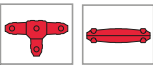
Cast resin technology

	Straight-through joints	73
	Branch joints	82
	Straight-through and branch joints	98
	Universal connection and branch boxes	101
	Cast resins	103

Overview: BBC Cellpack Cast resin straight-through and branch joints / Universal connection and branch boxes

Products	Version		Type of cast resins				
	with screw connector(s)	with branch clamp(s)	EG	GG	CG	FG	UWR
Straight-through joints							
MR 0	-	-	●	-	-	-	-
M...EG	-	-	●	-	-	-	-
M...GG	-	-	-	●	-	-	-
M-Euroline	-	-	●	-	-	-	-
M...V-Euroline	●	-	●	-	-	-	-
MZ	-	-	●	-	-	-	-
MZ...FG	-	-	-	-	-	●	-
PV...EG, PVM...EG, PVS...EG	-	-	●	-	-	-	-
PVS...GG	-	-	-	●	-	-	-
Branch joints							
KAV	-	-	●	-	-	-	-
H	-	-	●	-	-	-	-
H 5-SYS	-	●	-	-	-	-	●
P...EG	-	-	●	-	-	-	-
P...GG	-	-	-	●	-	-	-
T...EG	-	-	●	-	-	-	-
T...GG	-	-	-	●	-	-	-
T...V AK	-	●	●	-	-	-	-
Y...EG	-	-	●	-	-	-	-
Y...GG	-	-	-	●	-	-	-
Y...V AK	-	●	●	-	-	-	-
YCP	-	-	●	-	-	-	-
D1	-	-	●	-	-	-	-
Straight-through and branch joints							
M1	-	●	●	-	-	-	-
T1	-	●	●	-	-	-	-
Y1	-	●	●	-	-	-	-
Universal connection and branch boxes							
Universal Box CG	-	●	-	-	●	-	-

- included in the scope of delivery
- not included in the scope of delivery



MR 0

Cast resin straight-through joint

particularly for small cross sections, for polymeric cables and conductors, control cables and signal cables

Universally suitable for connecting polymeric cables or conductors insulated with PVC, PE, XLPE and EPR (e.g. N(A)YY, NYM, TT). Suitable for compression connectors on copper and aluminium conductors.



Characteristics

- Compact dimensions
- Splice area visible before casting
- High-quality transparent shockproof plastic shell
- Funnel clips for easy casting
- Suitable for vertical casting
- Resistant to chemical agents
- Resistant to alkaline earth elements
- Stabilized against UV rays
- Longitudinally and transversely watertight
- High electrical insulating values
- High mechanical strength
- Ready for immediate operation
- Quick and easy assembly saves time and reduces costs

Application/Suitability

- Indoor
- Outdoor
- Underground
- Water
- Submersible pumps
- Installation ducts

Voltage level

- U_0/U_m 0.6/1 (1.2) kV

Test standards

- DIN EN 50393 (corresponds to VDE 0278)

Storage conditions/Shelf life

- Cast resin up to 40 months



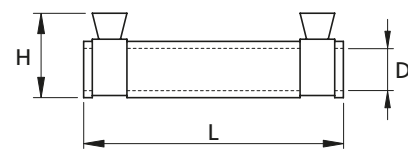

Dimensions



Scope of delivery

Cover, hydrolysis resistance PUR type EG cast resin (containing the correct volume ready for mixing), packed in practical and easy-to-use two-chamber bags, transparent plastic shell, PVC insulation tape, protective gloves, funnel clips, assembly instructions

Optional accessory: Funnel set/Filling in funnel (on request)
Heat shrinkable crimp connector (see Connecting technology)
Cleaner UNIVERSAL CLEANER 121 (see Accessories)

						Polymeric cable					
						unarmoured					
											
Type	L mm	D mm	H mm	max. Cable-Ø mm	Nominal cross section per conductor mm ²					Art.-No.	
MR	02	120	26	40	16	25	6	4	2.5	1.5	124507
	05	180	26	40	16	25	6	4	4	2.5	124508

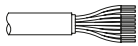
						Control and signal cable			
									
						0.75 mm ²		1.5 mm ²	
Type	L mm	D mm	H mm	max. Cable-Ø mm	Number of conductors			Art.-No.	
MR	02	120	26	40	16	8		5	124507
	05	180	26	40	16	16		8	124508



M...EG

Cast resin straight-through joint

for polymeric cables and conductors, control cables and signal cables

Universally suitable for connecting polymeric cables or conductors insulated with PVC, PE, XLPE and EPR (e.g. N(A)YY, NYM, TT). Suitable for compression or screw connectors on copper and aluminium conductors.

Characteristics

- Compact dimensions
- Splice area visible before casting
- High-quality transparent shockproof plastic shell
- Resistant to chemical agents
- Resistant to alkaline earth elements
- Stabilized against UV rays
- Longitudinally and transversely watertight
- High electrical insulating values
- High mechanical strength
- Ready for immediate operation
- Quick and easy assembly saves time and reduces costs

Application/Suitability

- Indoor
- Outdoor
- Underground
- Water
- Installation ducts

Voltage level

- U_0/U_m 0.6/1 (1.2) kV

Test standards

- DIN EN 50393 (corresponds to VDE 0278)

Storage conditions/Shelf life

- Cast resin up to 40 months



Dimensions

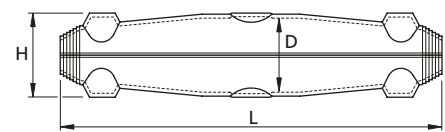

M 0 EG - M 6 EG

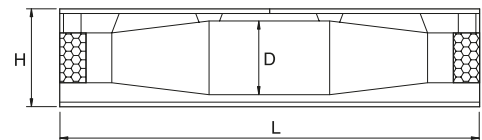

M 7 EG - M 8 EG

Scope of delivery

Hydrolysis resistance PUR type EG cast resin (containing the correct volume ready for mixing), packed in practical and easy-to-use two-chamber bags, transparent plastic shell, fill and air-release funnels, PVC insulation tape, protective gloves, assembly instructions

Optional accessory: Shield continuity wire SVL (see Accessories)
Connectors (see Connecting technology)
Cleaner UNIVERSAL CLEANER 121 (see Accessories)

Note: Armour continuity kit for armoured cable available on request.

Type	L mm	D mm	H mm	max. Cable-Ø mm	Polymeric cable										Art.-No.		
					unarmoured					with concentric conductor		armoured					
					1x	2x	3x	4x	5x	3x	4x	3x	4x				
					max. Nominal cross section per conductor mm ²												
M	0 EG	185	32	37	15	25	10	6	6	4							124293
	1 EG	240	40	45	22	95	25	16	16	10	10/10						124294
	2 EG	265	45	50	30	185	50	35	25	16	25/25	16/16	16	16			124295
	2.5 EG	310	58	65	37	300	70	70	50	35	35/35	25/25	35	16 - 35			124296
	3 EG	355	70	80	42	400	120	95	70	50	50/50	50/25	50	35 - 50			124297
	4 EG	430	90	98	52	500		120	95	70	95/95	70/35	95	50 - 95			124298
	5 EG	550	110	120	62	1000		240	185	120	150/150	120/70	120	95 - 120			124299
	6 EG	660	145	165	80			300	240	185	240/240	240/120	240	120 - 240			124300
	7 EG	900	150	190	90			400	300	240							124308
	8 EG	1100	150	190	90						400/400	300/150	400	300 - 400			124309

Type	L mm	D mm	H mm	max. Cable-Ø mm	Control and signal cable					Art.-No.	
					0,4 mm	0,6 mm	0,8 mm	0,75 mm ²	1,5 mm ²		
					Number of wire pairs						
					Number of conductors						
M	0 EG	185	32	37	15	6 - 20	6 - 10	6	16	8	124293
	1 EG	240	40	45	22	30 - 70	20 - 30	10 - 20	56	21	124294
	2 EG	265	45	50	30	100 - 150	40 - 70	30 - 40	114	56	124295
	2.5 EG	310	58	65	37	200 - 250	100 - 120	50 - 70	154	96	124296
	3 EG	355	70	80	42	300	150	100 - 120	200	133	124297

Shield continuity wire SVL required for telecommunication cables.



M...GG

Cast resin straight-through joint

for polymeric cables and conductors, control cables and signal cables

Universally suitable for connecting polymeric cables or conductors insulated with PVC, PE, XLPE and EPR (e.g. N(A)YY, NYM, TT). Suitable for compression or screw connectors on copper and aluminium conductors.

Characteristics

- Compact dimensions
- Splice area visible before casting
- High-quality transparent shockproof plastic shell
- Resistant to chemical agents
- Resistant to alkaline earth elements
- Stabilized against UV rays
- Longitudinally and transversely watertight
- High electrical insulating values
- High mechanical strength
- Ready for immediate operation
- Quick and easy assembly saves time and reduces costs

Application/Suitability

- Indoor
- Outdoor
- Underground
- Water
- Installation ducts

Voltage level

- U_0/U_m 0.6/1 (1.2) kV

Test standards

- DIN EN 50393 (corresponds to VDE 0278)

Storage conditions/Shelf life

- Cast resin up to 24 months



Dimensions

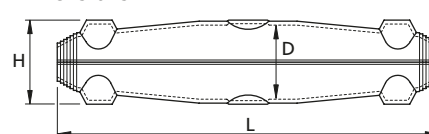

M 0 GG - M 6 GG

Scope of delivery

Hydrolysis resistance PUR type GG cast resin (containing the correct volume ready for mixing), packed in practical and easy-to-use two-chamber bags, transparent plastic shell, fill and air-release funnels, PVC insulation tape, protective gloves, assembly instructions

Optional accessory: Shield continuity wire SVL (see Accessories)
Connectors (see Connecting technology)
Cleaner UNIVERSAL CLEANER 121 (see Accessories)

Note: Armour continuity kit for armoured cable available on request.

		Polymeric cable														
		unarmoured					with concentric conductor		armoured							
		1x	2x	3x	4x	5x	3x	4x	3x	4x						
Type	L mm	D mm	H mm	max. Cable-Ø mm	max. Nominal cross section per conductor mm ²										Art.-No.	
M	0 GG	185	32	37	15	25	10	6	6	4						353703
	1 GG	240	40	45	22	95	25	16	16	10	10/10					353717
	2 GG	265	45	50	30	185	50	35	25	16	25/25	16/16	16	16	353718	
	2.5 GG	310	58	65	37	300	70	70	50	35	35/35	25/25	35	16 - 35	353719	
	3 GG	355	70	80	42	400	120	95	70	50	50/50	50/25	50	35 - 50	353740	
	4 GG	430	90	98	52	500		120	95	70	95/95	70/35	95	50 - 95	353741	
	5 GG	550	110	120	62	1000		240	185	120	150/150	120/70	120	95 - 120	353742	
	6 GG	660	145	165	80			300	240	185	240/240	240/120	240	120 - 240	353743	

		Control and signal cable											
		0,4 mm		0,6 mm		0,8 mm		0,75 mm ²		1,5 mm ²			
Type	L mm	D mm	H mm	max. Cable-Ø mm	Number of wire pairs					Number of conductors		Art.-No.	
M	0 GG	185	32	37	15	6 - 20	6 - 10	6	16	8	353703		
	1 GG	240	40	45	22	30 - 70	20 - 30	10 - 20	56	21	353717		
	2 GG	265	45	50	30	100 - 150	40 - 70	30 - 40	114	56	353718		
	2.5 GG	310	58	65	37	200 - 250	100 - 120	50 - 70	154	96	353719		
	3 GG	355	70	80	42	300	150	100 - 120	200	133	353740		

Shield continuity wire SVL required for telecommunication cables.



M-Euroline Cast resin straight-through joint

for polymeric cables and conductors

Universally suitable for connecting polymeric cables or conductors insulated with PVC, PE, XLPE and EPR (e.g. N(A)YY, NYM, TT). Suitable for compression or screw connectors on copper and aluminium conductors.

Characteristics

- Compact dimensions
- Splice area visible before casting
- High-quality transparent shockproof plastic shell
- Large filler aperture to facilitate casting
- Resistant to chemical agents
- Resistant to alkaline earth elements
- Stabilized against UV rays
- Longitudinally and transversely watertight
- High electrical insulating values
- High mechanical strength
- Ready for immediate operation
- Quick and easy assembly saves time and reduces costs

Application/Suitability

- Indoor
- Outdoor
- Underground
- Water
- Installation ducts

Voltage level

- U_0/U_m 0.6/1 (1.2) kV

Test standards

- DIN EN 50393 (corresponds to VDE 0278)

Storage conditions/Shelf life

- Cast resin up to 40 months

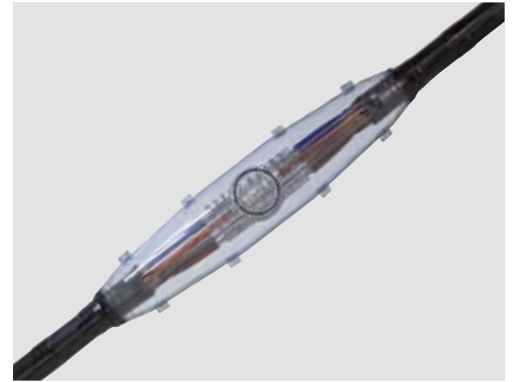

Dimensions

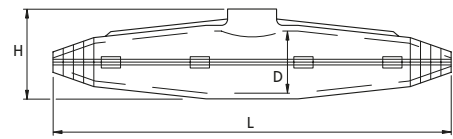

M 11 - M 16

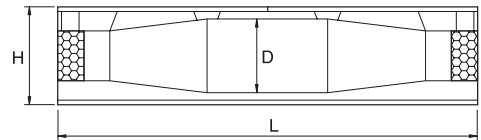

M 17

Scope of delivery

Cover, hydrolysis resistance PUR type EG cast resin (containing the correct volume ready for mixing), packed in practical and easy-to-use two-chamber bags, transparent plastic shell, spacers (up to M13), PVC insulation tape, protective gloves, assembly instructions

Optional accessory: Connectors (see Connecting technology)
Cleaner UNIVERSAL CLEANER 121 (see Accessories)

Note: Armour continuity kit for armoured cable available on request.

Type	L mm	D mm	H mm	max. Cable-Ø mm	Polymeric cable							Art.-No.
					unarmoured				with concentric conductor		armoured	
					1x	3x	4x	5x	3x	4x	4x	
max. Nominal cross section per conductor mm ²												
M 11	190	36	50	26	50	10	10	6	10/10		4	124169
M 12	260	47	63	34	150	25	25	16	25/25	16/16	10	124170
M 13 S	310	55	68	43	240	35	35	25	35/35	25/16	25	124171
M 13	360	55	75	43	400	50	50	35	50/50	25/16	35	124172
M 14 S	350	70	95	48	630	70	70	50	70/70	50/50	50	124173
M 14	400	70	95	48	630	95	95	70	95/95	50/50	70	124174
M 15	530	100	120	63	1000	150	150	120	150/150	120/70	120	124175
M 16	700	125	160	81		240	240	185	240/120	185/70	240	124176
M 17	900	150	190	90		300	400	240	300/300	240/120	240	169406



M...V-Euroline Cast resin straight-through joint

with screw connectors, for polymeric cables and conductors

Universally suitable for connecting polymeric cables or conductors insulated with PVC, PE, XLPE and EPR (e.g. N(A)YY, NYM, TT). With screw connectors, suitable for aluminium or copper conductors.

Characteristics

- Compact dimensions
- Splice area visible before casting
- High-quality transparent shockproof plastic shell
- Large filler aperture to facilitate casting
- Resistant to chemical agents
- Resistant to alkaline earth elements
- Stabilized against UV rays
- Longitudinally and transversely watertight
- High electrical insulating values
- High mechanical strength
- Ready for immediate operation
- Quick and easy assembly saves time and reduces costs

Application/Suitability

- Indoor
- Outdoor
- Underground
- Water
- Installation ducts

Voltage level

- U_0/U_m (U_m) 0.6/1 (1.2) kV

Test standards

- DIN EN 50393 (corresponds to VDE 0278)

Storage conditions/Shelf life

- Cast resin up to 40 months



Dimensions

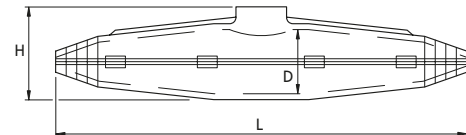

Scope of delivery

Cover, hydrolysis resistance PUR type EG cast resin (containing the correct volume ready for mixing), packed in practical and easy-to-use two-chamber bags, transparent plastic shell, screw connectors, spacers, PVC insulation tape, protective gloves, assembly instructions

Optional accessory: Cleaner UNIVERSAL CLEANER 121 (see Accessories)

Type	L mm	D mm	H mm	max. Cable-Ø mm	Polymeric cable					Art.-No.	
					unarmoured			with concentric conductor			
					3x	4x	5x	3x	4x		
M	11 V	190	36	50	26	1.5 - 6	1.5 - 6	1.5 - 6	1.5/1.5 - 6/6	1.5/1.5 - 6/6	131863
	12 V	260	47	63	34	10 - 16	10 - 16	10 - 16	10/10 - 16/16	10/10 - 16/16	131867
	13 SV	310	55	68	43	16 - 25	16 - 25		16/16 - 25/25		131866
	13 V	360	55	75	43	25 - 35	25 - 35		25/25 - 35/35		131864
	14 V	400	70	95	48	50 - 70	50 - 70		50/50 - 70/70		131865



MZ

Cast resin straight-through joint

for control cables and signal cables

Universally suitable for connecting control cables and signal cables or as a cable sheath repair protection joint. Suitable for compression connectors.

Characteristics

- Compact dimensions
- Splice area visible before casting
- High-quality transparent shockproof plastic shell
- Large filler aperture to facilitate casting
- Resistant to chemical agents
- Resistant to alkaline earth elements
- Stabilized against UV rays
- Longitudinally and transversely watertight
- High electrical insulating values
- High mechanical strength
- Ready for immediate operation
- Quick and easy assembly saves time and reduces costs

Application/Suitability

- Indoor
- Outdoor
- Underground
- Water
- Installation ducts

Voltage level

- U_0/U_m 0.6/1 (1.2) kV

Test standards

- DIN EN 50393 (corresponds to VDE 0278)

Storage conditions/Shelf life

- Cast resin up to 40 months



Dimensions

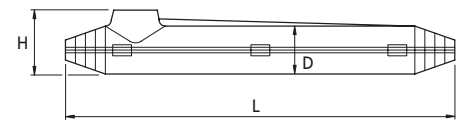

MZ 00 - MZ 0

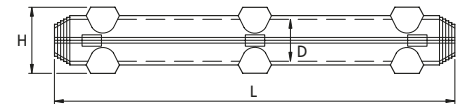

MZ 1 - MZ 3

Scope of delivery

Cover, hydrolysis resistance PUR type EG cast resin (containing the correct volume ready for mixing), packed in practical and easy-to-use two-chamber bags, transparent plastic shell, spacer mesh, fill and air-release funnels, PVC insulation tape, protective gloves, assembly instructions

Optional accessory: Shield continuity wire SVL (see Accessories)
Compression connectors (see Connecting technology)
Cleaner UNIVERSAL CLEANER 121 (see Accessories)

Type	L mm	D mm	H mm	max. Cable-Ø mm	Control and signal cable					Art.-No.	
					0.4 mm	0.6 mm	0.8 mm	1.5 mm ²	2.5 mm ²		
					Number of wire pairs			Number of conductors			
MZ	00	180	23	35	20	10 - 15	5 - 10	5 - 10	7	5	124505
	0	250	35	55	32	15 - 30	10 - 20	10 - 20	15	10	124506
	1	400	33	57	30	30 - 60	20 - 50	20 - 40	30	20	124510
	2	500	41	67	40	70 - 100	60 - 100	50 - 70	50	40	124513
	3	600	51	78	50	150 - 200	150 - 250	100 - 150	60	50	124511

Shield continuity wire SVL required for telecommunication cables.



MZ...FG

Cast resin straight-through joint

drummable, with flexibel cast resin, for unarmoured polymeric cables and conductors

Universally applicable as repair joints for flexible rubber cable.

Characteristics

- Compact dimensions
- Splice area visible before casting
- High-quality transparent shockproof plastic shell
- Resistant to chemical agents
- Resistant to alkaline earth elements
- Stabilized against UV rays
- Longitudinally and transversely watertight
- High electrical insulating values
- High mechanical strength
- Ready for immediate operation
- Quick and easy assembly saves time and reduces costs

Application/Suitability

- Indoor
- Outdoor
- Underground
- Water
- Installation ducts

Voltage level

- U_0/U_m 0.6/1 (1.2) kV

Test standards

- DIN EN 50393 (corresponds to VDE 0278)

Storage conditions/Shelf life

- Cast resin up to 24 months



Dimensions

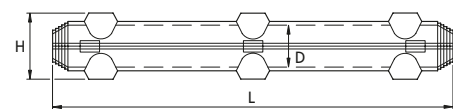

Scope of delivery

Hydrolysis resistance PUR type FG cast resin (containing the correct volume ready for mixing), packed in practical and easy-to-use two-chamber bags, transparent plastic shell, heat shrinkable tubes for connectors, fill and air-release funnels, PVC insulation tape, protective gloves, assembly instructions

Optional accessory: Cleaner UNIVERSAL CLEANER 121 (see Accessories)

		Polymeric cable						
		unarmoured						
		4x			5x			
Type	L mm	D mm	H mm	max. Cable-Ø mm	max. Nominal cross section per conductor mm ²		Art.-No.	
MZ	2 FG	500	41	67	40	25	16	124517
	3 FG	600	51	78	50	50	25	124518



PV...EG, PVM...EG, PVS...EG Cast resin straight-through joint

with integrated strain relief, for polymeric cables and conductors, with cast resin EG

Universally suitable for connecting polymeric cables or conductors insulated with PVC, PE, XLPE and EPR (e.g. N(A)YY, TT). Suitable for compression or screw connectors on copper and aluminium conductors.

Characteristics

- Compact dimensions
- High-quality brown shockproof plastic shell
- Integrated strain relief
- Large filler aperture to facilitate casting
- Resistant to chemical agents
- Resistant to alkaline earth elements
- Stabilized against UV rays
- Longitudinally and transversely watertight
- High electrical insulating values
- High mechanical strength
- Ready for immediate operation
- Quick and easy assembly saves time and reduces costs

Application/Suitability

- Indoor
- Outdoor
- Underground
- Water
- Installation ducts

Voltage level

- U_0/U_m 0.6/1 (1.2) kV

Test standards

- DIN EN 50393 (corresponds to VDE 0278)

Storage conditions/Shelf life

- Cast resin up to 40 months

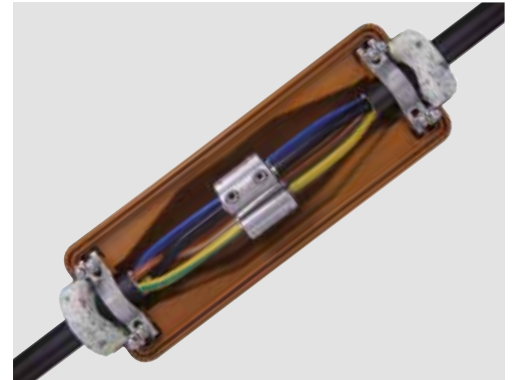



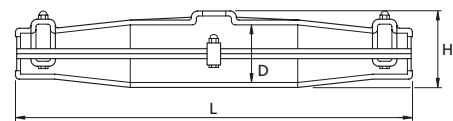

Dimensions



Scope of delivery

Hydrolysis resistance PUR type EG cast resin (containing the correct volume ready for mixing), packed in practical and easy-to-use two-chamber bags, sealing gaskets, plastic shell, protective gloves, strain relief, assembly instructions

Optional accessory: Connectors (see Connecting technology)
Cleaner UNIVERSAL CLEANER 121 (see Accessories)

Polymeric cable			
unarmoured		with concentric conductor	
			
3x	4x	3x	4x

Type	L mm	D mm	H mm	max. Cable-Ø mm	Nominal cross section per conductor mm ²				Art.-No.	
PV	3 EG	427	100	120	40	50 - 95	35 - 70	70/70	50/50	127705
PVM	5 EG	642	116	135	58	95 - 150	95 - 150	150/150	120/120	127706
PVS	5 EG	642	136	160	48	95 - 150	95 - 150	150/150	120/120	127708
PVM	6 EG	850	137	185	58	185 - 300	185 - 240	240/120	185/185	127707



PVS...GG

Cast resin straight-through joint

with integrated strain relief, for polymeric cables and conductors, with cast resin GG (reduced hazard-class)

Universally suitable for connecting polymeric cables or conductors insulated with PVC, PE, XLPE and EPR (e.g. N(A)YY, TT). Suitable for compression or screw connectors on copper and aluminium conductors.

Characteristics

- Compact dimensions
- High-quality brown shockproof plastic shell
- Integrated strain relief
- Large filler aperture to facilitate casting
- Resistant to chemical agents
- Resistant to alkaline earth elements
- Stabilized against UV rays
- Longitudinally and transversely watertight
- High electrical insulating values
- High mechanical strength
- Ready for immediate operation
- Quick and easy assembly saves time and reduces costs

Application/Suitability

- Indoor
- Outdoor
- Underground
- Water
- Installation ducts

Voltage level

- U_0/U_m (U_m) 0.6/1 (1.2) kV

Test standards

- DIN EN 50393 (corresponds to VDE 0278)

Storage conditions/Shelf life

- Cast resin up to 24 months

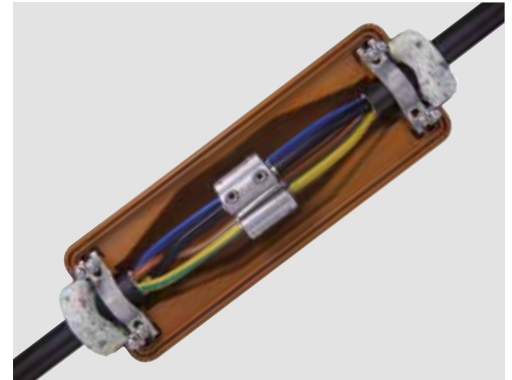

Dimensions

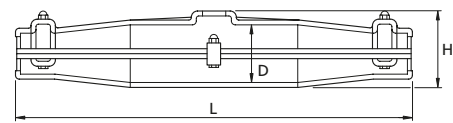

Scope of delivery

Hydrolysis resistance PUR type GG cast resin (containing the correct volume ready for mixing), packed in practical and easy-to-use two-chamber bags, sealing gaskets, plastic shell, protective gloves, strain relief, assembly instructions

Optional accessory: Connectors (see Connecting technology)
Cleaner UNIVERSAL CLEANER 121 (see Accessories)

Type	L mm	D mm	H mm	max. Cable-Ø mm	Polymeric cable				Art.-No.
					unarmoured		with concentric conductor		
					3x	4x	3x	4x	
PVS 5 GG	642	136	160	48	Nominal cross section per conductor mm ²				335567
					95 - 150	95 - 150	150/150	120/120	



KAV

Cast resin branch joint

for polymeric cables and conductors

Universally suitable for branching cables and conductors insulated with PVC, PE and XLPE (e.g. N(A)YY, GKN). Suitable for cable branch clamps / ring clamps and compression connectors on copper and aluminium conductors.

Characteristics

- Compact dimensions
- Splice area visible before casting
- High-quality transparent shockproof plastic shell
- Large filler aperture to facilitate casting
- Resistant to chemical agents
- Resistant to alkaline earth elements
- Stabilized against UV rays
- Longitudinally and transversely watertight
- High electrical insulating values
- High mechanical strength
- Ready for immediate operation
- Quick and easy assembly saves time and reduces costs

Application/Suitability

- Indoor
- Outdoor
- Underground
- Water
- Installation ducts

Voltage level

- U_0/U_m 0.6/1 (1.2) kV

Test standards

- DIN EN 50393 (corresponds to VDE 0278)

Storage conditions/Shelf life

- Cast resin up to 40 months



Dimensions

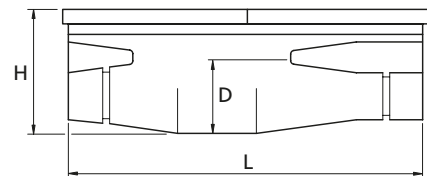

KAV 1 - KAV 2

Scope of delivery

Hydrolysis resistance PUR type EG cast resin (containing the correct volume ready for mixing), packed in practical and easy-to-use two-chamber bags, sealing gaskets, transparent plastic shell with locking bar, sealing tape, protective gloves, assembly instructions

- Optional accessory:
- Ring clamp (see Connecting technology)
 - Screw branch clamp AK (see Connecting technology)
 - Split bolt clamp FK (see Connecting technology)
 - Compression connectors (see Connecting technology)
 - Cleaner UNIVERSAL CLEANER 121 (see Accessories)

Note: Additional earthing set available on request.

Type	L mm	D mm	H mm	max. Cable-Ø mm		Polymeric cable				Art.-No.	
				Main cable	Branch cable	unarmoured		armoured			
						Nominal cross section per conductor mm ²					
						Main cable	Branch cable	Main cable	Branch cable		
KAV	1	230	58	78	30	20	16	6			131095
	2	270	58	78	33	20	25	10	6	4	124861



H

Cast resin branch joint

for polymeric cables and conductors

Universally suitable for branching cables and conductors insulated with PVC, PE and XLPE (e.g. N(A)YY, TT...). Suitable for assembly of individual one-core branch clamps according to type (split bolt clamps for H 1 and H 2) or branch clamps (H 5...and H 6) and compression or screw connectors.

Characteristics

- Compact dimensions
- Splice area visible before casting
- High-quality transparent shockproof plastic shell
- Can be used as double-branch joint (H 1 and H 2)
- Large filler aperture to facilitate casting
- Resistant to chemical agents
- Resistant to alkaline earth elements
- Stabilized against UV rays
- Longitudinally and transversely watertight
- High electrical insulating values
- High mechanical strength
- Ready for immediate operation
- Quick and easy assembly saves time and reduces costs

Application/Suitability

- Indoor
- Outdoor
- Underground
- Water
- Installation ducts

Voltage level

- U_0/U_m 0.6/1 (1.2) kV

Test standards

- DIN EN 50393 (corresponds to VDE 0278)

Storage conditions/Shelf life

- Cast resin up to 40 months



Dimensions

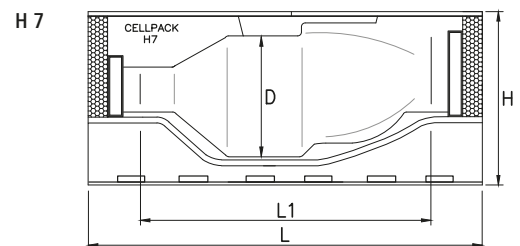
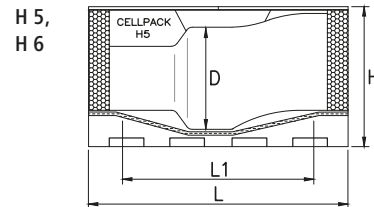
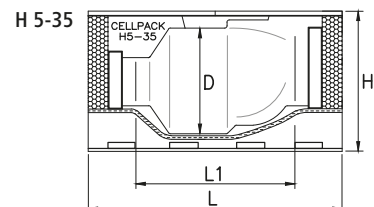
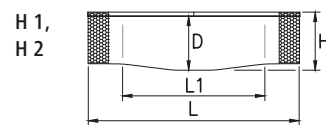

Scope of delivery

Hydrolysis resistance PUR type EG cast resin (containing the correct volume ready for mixing), packed in practical and easy-to-use two-chamber bags, sealing gaskets, transparent plastic shell, centring elements (H 5-35 and H 7), steel clamps (H 5 and H 6), protective gloves, assembly instructions

Optional accessory: Screw branch clamp AK (see Connecting technology)
 Branch clamp HE 1/70/150 (see Connecting technology)
 Split bolt clamp FK (see Connecting technology)
 Connectors (see Connecting technology)
 Cleaner UNIVERSAL CLEANER 121 (see Accessories)

Note: H5 branch joints can be used with branch clamps HE 1/70/150 (see Connecting technology).

Polymeric cable	
unarmoured	with concentric conductor
 4x	 3x

Type	L mm	L1 mm	D mm	H mm	max. Cable-Ø mm		Nominal cross section per conductor mm ²				Art.-No.	
					Main cable	Branch cable	Main cable	Branch cable	Main cable	Branch cable		
H	1	235	155	60	70	25	20	16	6			124789
	2	270	180	60	80	32	22	16 - 25	6 - 10			124790
	5	300	246	115	170	50	32	95 - 150	16 - 50			124787
	5-35	290	180	135	185	52	36	95 - 150	16 - 70			124815
	6	350	296	135	190	55	39	120 - 185	50 - 70	120/70 - 150/70	35/16 - 70/35	124788
	7	490	330	180	230	59	54	95 - 240	70 - 150	95/95 - 240/240	70/70 - 150/150	124786



H 5-SYS

Cast resin branch joint for house connections

with branch clamp, for unarmoured polymeric cables

For branching of cables with insulation made of PVC, PE and XLPE (e.g. N(A)YY, GN-CLN...). With branch clamp, suitable for copper and aluminium conductors.

Characteristics

- High-quality transparent shockproof plastic shell
- Cast resin can be poured in with an angle up to 45° or laterally up to 45°
- Compatible with a branching system with specific contact geometry designed to facilitate connection of branch cable in visible area, ensuring safe handling
- Easy seal application
- Large filler aperture to facilitate casting
- Can be installed / operated while under voltage
- Resistant to chemical agents
- Resistant to alkaline earth elements
- Stabilized against UV rays
- High electrical insulating values
- High mechanical strength
- Ready for immediate operation
- Quick and easy assembly saves time and reduces costs

Application/Suitability

- Indoor
- Outdoor
- Underground
- Water
- Installation ducts

Voltage level

- U_0/U_m 0.6/1 (1.2) kV

Test standards

- DIN EN 50393 (corresponds to VDE 0278)

Storage conditions/Shelf life

- Cast resin up to 24 months

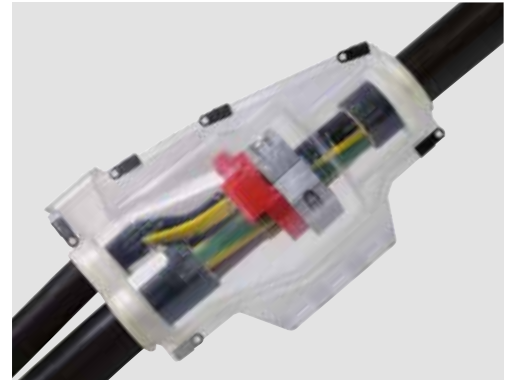

Dimensions

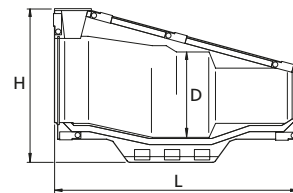

Scope of delivery

Hydrolysis resistance PUR type UWR cast resin (containing the correct volume ready for mixing), packed in practical and easy-to-use two-chamber bags, transparent plastic shell, branch clamp HE 1/70/150, sealing tapes, protective gloves, assembly instructions

Optional accessory: Cleaner UNIVERSAL CLEANER 121 (see Accessories)

Type	L mm	D mm	H mm	max. Cable-Ø mm		Nominal cross section per conductor mm ²			Art.-No.
				Main cable	Branch cable	Main cable SE	Main cable SM	Branch cable	
H 5-SYS 70-150	270	110	180	46	36	95 - 150	70 - 120	16 - 50	195816



P...EG

Cast resin branch joint

with integrated strain relief, for polymeric cables and mass-impregnated paper cables, with cast resin EG

Universally suitable for branching polymeric cables insulated with PVC, PE, XLPE and paper (e.g. N(A)YY, N(A)KBA, GN-CLN, TT) with or without concentric conductor and mass-impregnated paper cables. Suitable for branch clamps on copper and aluminium conductors.

Characteristics

- High-quality brown shockproof plastic shell
- Compact design
- Integrated strain relief
- Large filler aperture to facilitate casting
- Resistant to chemical agents
- Resistant to alkaline earth elements
- Stabilized against UV rays
- Longitudinally and transversely watertight
- High electrical insulating values
- High mechanical strength
- Ready for immediate operation
- Quick and easy assembly saves time and reduces costs

Application/Suitability

- Indoor
- Outdoor
- Underground
- Water
- Installation ducts

Voltage level

- U_0/U_m (U_m) 0.6/1 (1.2) kV

Test standards

- DIN EN 50393 (corresponds to VDE 0278)

Storage conditions/Shelf life

- Cast resin up to 40 months



Dimensions

P 2 EG

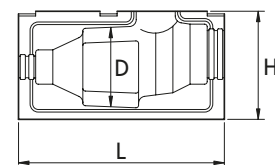

P 3 EG,
PC 5 EG,
PC 7 EG

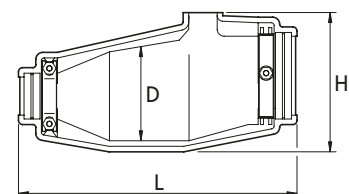

PD 5 EG

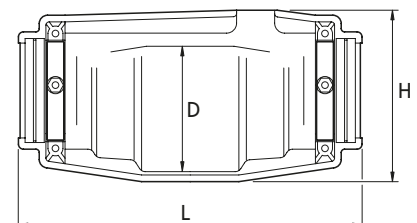

PB 4 EG,
PE 7 EG

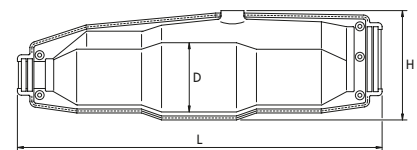

P 4 EG - P 7 EG

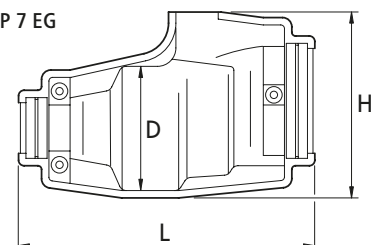

Scope of delivery

Hydrolysis resistance PUR type EG cast resin (containing the correct volume ready for mixing), packed in practical and easy-to-use two-chamber bags, sealing gaskets, plastic shell with integrated strain relief, hexagon head screws and nuts, assembly instructions

Optional accessory: Branch clamp HE 1/70/150 (see Connecting technology)
Branch clamp KP (see Connecting technology)
Cleaner UNIVERSAL CLEANER 121 (see Accessories)

Note: For branch joints sizes larger than P 5 EG, branch clamps HE 1/70/150 can be used (see Connecting technology).



→ Continued on the next page





→ Continuation

P...EG Cast resin branch joint

LOW VOLTAGE
Cast resin technology

Mass-impregnated paper cable		Polymeric cable unarmoured	
 3x	 4x	 4x	

Type	L mm	D mm	H mm	max. Cable-Ø mm		Nominal cross section per conductor mm ²				Art.-No.	
				Main cable	Branch cable	Main cable	Branch cable	Main cable	Branch cable		
P	2 EG	240	90	127	13 - 25	13 - 25			2.5 - 16	2.5 - 16	127697
	3 EG	342	90	160	15 - 35	12 - 30	10 - 16	10 - 16	10 - 25	4 - 16	127703
	4 EG	302	113	200	28 - 45	21 - 34			50 - 95	16 - 35	127698
	5 EG	325	135	200	37 - 54	20 - 36			95 - 150	16 - 50	127733
	6 EG	432	135	210	44 - 59	28 - 45			150 - 185	50 - 95	127695
	7 EG	442	150	245	40 - 59	40 - 59			120 - 185	120 - 150	127696
	PD	5 EG	427	130	212	37 - 54	20 - 36			95 - 150	16 - 50
PC	5 EG	392	130	210	35 - 54	20 - 36			95 - 185	16 - 50	127699
	7 EG	472	150	225	40 - 59	40 - 50			150 - 240	50 - 95	127700
PB	4 EG	532	120	200	30 - 50	27 - 44	95 - 150	95 - 150	95 - 150	50 - 95	127763
PE	7 EG	692	180	285	40 - 59	40 - 59			150 - 240	120 - 185	127709

Polymeric cable with concentric conductor	
 3x	 4x

Type	L mm	D mm	H mm	max. Cable-Ø mm		Nominal cross section per conductor mm ²				Art.-No.	
				Main cable	Branch cable	Main cable	Branch cable	Main cable	Branch cable		
P	2 EG	240	90	127	13 - 25	13 - 25					127697
	3 EG	342	90	160	15 - 35	12 - 30	10/10 - 16/16	4/4 - 16/16	10/10 - 16/16	4/4 - 16/16	127703
	4 EG	302	113	200	28 - 45	21 - 34					127698
	5 EG	325	135	200	37 - 54	20 - 36					127733
	6 EG	432	135	210	44 - 59	28 - 45					127695
	7 EG	442	150	245	40 - 59	40 - 59					127696
	PD	5 EG	427	130	212	37 - 54	20 - 36				
PC	5 EG	392	130	210	35 - 54	20 - 36	95/95 - 150/150	16/16 - 50/50	95/95 - 150/150	16/16 - 50/50	127699
	7 EG	472	150	225	40 - 59	40 - 50	150/150 - 185/185	50/50 - 95/95	150/150 - 185/185	50/50 - 95/95	127700
PB	4 EG	532	120	200	30 - 50	27 - 44		50/50 - 95/95		50/25 - 95/50	127763
PE	7 EG	692	180	285	40 - 59	40 - 59					127709



P...GG

Cast resin branch joint

with integrated strain relief, for polymeric cables and mass-impregnated paper cables, with cast resin GG (reduced hazard-class)

Universally suitable for branching polymeric cables insulated with PVC, PE, XLPE and paper (e.g. N(A)YY, N(A)KBA, GN-CLN, TT) with or without concentric conductor and mass-impregnated paper cables. Suitable for branch clamps on copper and aluminium conductors.

Characteristics

- High-quality brown shockproof plastic shell
- Compact design
- Integrated strain relief
- Large filler aperture to facilitate casting
- Resistant to chemical agents
- Resistant to alkaline earth elements
- Stabilized against UV rays
- Longitudinally and transversely watertight
- High electrical insulating values
- High mechanical strength
- Ready for immediate operation
- Quick and easy assembly saves time and reduces costs

Application/Suitability

- Indoor
- Outdoor
- Underground
- Water
- Installation ducts

Voltage level

- U_0/U_m 0.6/1 (1.2) kV

Test standards

- DIN EN 50393 (corresponds to VDE 0278)

Storage conditions/Shelf life

- Cast resin up to 24 months



Dimensions

P 2 GG

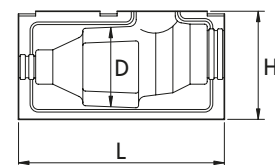

P 3 GG,
PC 5 GG

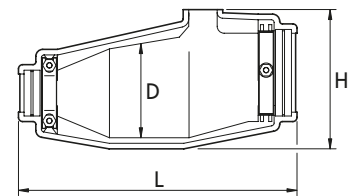

PB 4 GG,
PE 7 GG

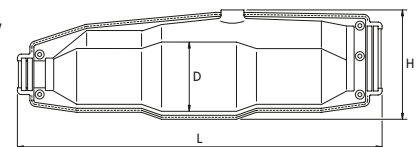

P 5 GG - P 7 GG

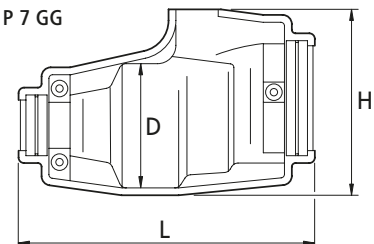

Scope of delivery

Hydrolysis resistance PUR type GG cast resin (containing the correct volume ready for mixing), packed in practical and easy-to-use two-chamber bags, sealing gaskets, plastic shell with integrated strain relief, hexagon head screws and nuts, assembly instructions

Optional accessory: Branch clamp HE 1/70/150 (see Connecting technology)
Branch clamp KP (see Connecting technology)
Cleaner UNIVERSAL CLEANER 121 (see Accessories)

Note: For branch joints sizes larger than P 5 GG, branch clamps HE 1/70/150 can be used (see Connecting technology).

→ Continued on the next page



→ Continuation

P...GG Cast resin branch joint

LOW VOLTAGE
Cast resin technology

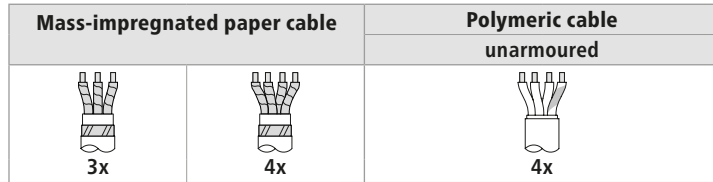

Type	L mm	D mm	H mm	max. Cable-Ø mm		Nominal cross section per conductor mm ²				Art.-No.	
				Main cable	Branch cable	Main cable	Branch cable	Main cable	Branch cable		
P	2 GG	240	90	127	13 - 25	13 - 25			2.5 - 16	2.5 - 16	329587
	3 GG	342	90	160	15 - 35	12 - 30	10 - 16	10 - 16	10 - 25	4 - 16	329589
	5 GG	325	135	200	37 - 54	20 - 36			95 - 150	16 - 50	329567
	6 GG	432	135	210	44 - 59	28 - 45			150 - 185	50 - 95	329569
	7 GG	442	150	245	40 - 59	40 - 59			120 - 185	120 - 150	329588
PC	5 GG	392	130	210	35 - 54	20 - 36			95 - 185	16 - 50	335566
PB	4 GG	532	120	200	30 - 50	27 - 44	95 - 150	95 - 150	95 - 150	50 - 95	329572
PE	7 GG	692	180	285	40 - 59	40 - 59			150 - 240	120 - 185	335565

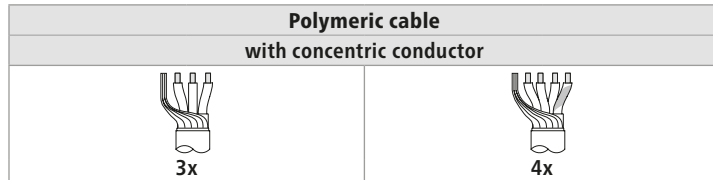

Type	L mm	D mm	H mm	max. Cable-Ø mm		Nominal cross section per conductor mm ²				Art.-No.	
				Main cable	Branch cable	Main cable	Branch cable	Main cable	Branch cable		
P	2 GG	240	90	127	13 - 25	13 - 25					329587
	3 GG	342	90	160	15 - 35	12 - 30	10/10 - 16/16	4/4 - 16/16	10/10 - 16/16	4/4 - 16/16	329589
	5 GG	325	135	200	37 - 54	20 - 36					329567
	6 GG	432	135	210	44 - 59	28 - 45					329569
	7 GG	442	150	245	40 - 59	40 - 59					329588
PC	5 GG	392	130	210	35 - 54	20 - 36	95/95 - 150/150	16/16 - 50/50	95/95 - 150/150	16/16 - 50/50	335566
PB	4 GG	532	120	200	30 - 50	27 - 44		50/50 - 95/95		50/25 - 95/50	329572
PE	7 GG	692	180	285	40 - 59	40 - 59					335565



T...EG

Cast resin branch joint

for polymeric cables and conductors

Universally suitable for branching polymeric cables or conductors insulated with PVC, PE, XLPE and EPR (e.g. N(A)YY, NYM, TT) with or without concentric conductor. Suitable for branch clamps on copper and aluminium conductors.

Characteristics

- Compact dimensions
- Splice area visible before casting
- High-quality transparent shockproof plastic shell
- Large filler aperture to facilitate casting
- Resistant to chemical agents
- Resistant to alkaline earth elements
- Stabilized against UV rays
- Longitudinally and transversely watertight
- High electrical insulating values
- High mechanical strength
- Ready for immediate operation
- Quick and easy assembly saves time and reduces costs

Application/Suitability

- Indoor
- Outdoor
- Underground
- Water
- Installation ducts

Voltage level

- $U_0/U (U_m)$ 0.6/1 (1.2) kV

Test standards

- DIN EN 50393 (corresponds to VDE 0278)

Storage conditions/Shelf life

- Cast resin up to 40 months



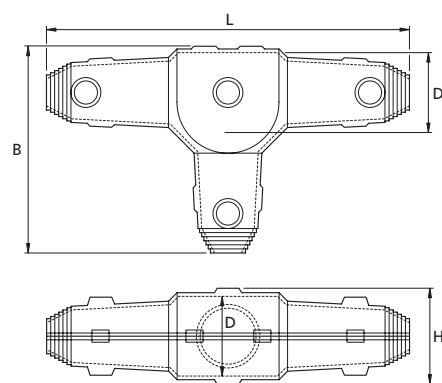

Dimensions



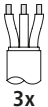

Scope of delivery

Hydrolysis resistance PUR type EG cast resin (containing the correct volume ready for mixing), packed in practical and easy-to-use two-chamber bags, transparent plastic shell, fill and air-release funnels, PVC insulation tape, protective gloves, assembly instructions

Optional accessory: Screw branch clamp AK (see Connecting technology)
Branch clamp KP (see Connecting technology)
Split bolt clamp FK (see Connecting technology)
Cleaner UNIVERSAL CLEANER 121 (see Accessories)

Polymeric cable unarmoured													
  													
Type	L mm	B mm	D mm	H mm	max. Cable-Ø mm	max. Nominal cross section per conductor mm ²						Art.-No.	
						Main cable	Branch cable	Main cable	Branch cable	Main cable	Branch cable		
T	1 EG	240	138	50	60	22	10	10	6	6	4	4	131149
	2 EG	267	154	60	70	30	25	25	16	10	10	10	133024
	2.5 EG	310	183	75	85	37	50	50	35	16	16	10	131855
	3 EG	354	212	90	100	42	70	70	50	25	25	16	131151
	4 EG	432	262	110	125	52	120	120	95	50	50	35	131778
5 EG	550	290	130	155	62	185	150	185	70			131854	

Polymeric cable with concentric conductor												
 												
Type	L mm	B mm	D mm	H mm	max. Cable-Ø mm	max. Nominal cross section per conductor mm ²				Art.-No.		
						Main cable	Branch cable	Main cable	Branch cable			
T	1 EG	240	138	50	60	22	6/6	6/6				131149
	2 EG	267	154	60	70	30	16/16	10/10	16/16	16/16		133024
	2.5 EG	310	183	75	85	37	35/35	16/16	35/16	25/16		131855
	3 EG	354	212	90	100	42	50/50	25/25	50/25	35/16		131151
	4 EG	432	262	110	125	52	95/95	50/50	95/50	70/35		131778
5 EG	550	290	130	155	62	185/185	70/70	150/70	95/50		131854	



T...GG

Cast resin branch joint

for polymeric cables and conductors

Universally suitable for branching polymeric cables or conductors insulated with PVC, PE, XLPE and EPR (e.g. N(A)YY, NYM, TT) with or without concentric conductor. Suitable for branch clamps on copper and aluminium conductors.

Characteristics

- Compact dimensions
- Splice area visible before casting
- High-quality transparent shockproof plastic shell
- Large filler aperture to facilitate casting
- Resistant to chemical agents
- Resistant to alkaline earth elements
- Stabilized against UV rays
- Longitudinally and transversely watertight
- High electrical insulating values
- High mechanical strength
- Ready for immediate operation
- Quick and easy assembly saves time and reduces costs

Application/Suitability

- Indoor
- Outdoor
- Underground
- Water
- Installation ducts

Voltage level

- $U_0/U (U_m)$ 0.6/1 (1.2) kV

Test standards

- DIN EN 50393 (corresponds to VDE 0278)

Storage conditions/Shelf life

- Cast resin up to 24 months



Dimensions

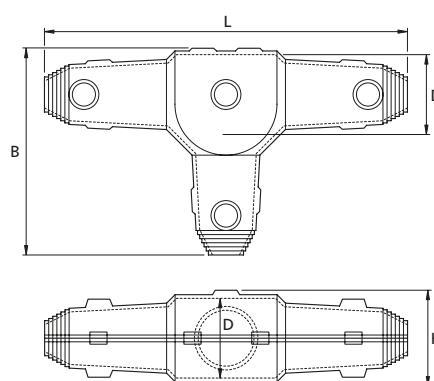

Scope of delivery

Hydrolysis resistance PUR type GG cast resin (containing the correct volume ready for mixing), packed in practical and easy-to-use two-chamber bags, transparent plastic shell, fill and air-release funnels, PVC insulation tape, protective gloves, assembly instructions

- Optional accessory: Screw branch clamp AK (see Connecting technology)
 Branch clamp KP (see Connecting technology)
 Split bolt clamp FK (see Connecting technology)
 Cleaner UNIVERSAL CLEANER 121 (see Accessories)

Polymeric cable unarmoured												
Type	L mm	B mm	D mm	H mm	max. Cable-Ø mm	max. Nominal cross section per conductor mm ²						Art.-No.
						3x		4x		5x		
						Main cable	Branch cable	Main cable	Branch cable	Main cable	Branch cable	
1 GG	240	138	50	60	22	10	10	6	6	4	4	353846
2 GG	267	154	60	70	30	25	25	16	10	10	10	353847
2.5 GG	310	183	75	85	37	50	50	35	16	16	10	353848
3 GG	354	212	90	100	42	70	70	50	25	25	16	353849
4 GG	432	262	110	125	52	120	120	95	50	50	35	353860

Polymeric cable with concentric conductor												
Type	L mm	B mm	D mm	H mm	max. Cable-Ø mm	max. Nominal cross section per conductor mm ²				Art.-No.		
						3x		4x				
						Main cable	Branch cable	Main cable	Branch cable			
1 GG	240	138	50	60	22	6/6	6/6					353846
2 GG	267	154	60	70	30	16/16	10/10	16/16		16/16		353847
2.5 GG	310	183	75	85	37	35/35	16/16	35/16		25/16		353848
3 GG	354	212	90	100	42	50/50	25/25	50/25		35/16		353849
4 GG	432	262	110	125	52	95/95	50/50	95/50		70/35		353860



T...V FKM

Cast resin branch joint

with split bolt branch clamps, for polymeric cables and conductors

Universally suitable for branching polymeric cables or conductors insulated with PVC, PE, XLPE and EPR (e.g. N(A)YY, NYM). With one-core branch clamps, suitable for copper and aluminium conductors.

Characteristics

- Compact dimensions
- Splice area visible before casting
- High-quality transparent shockproof plastic shell
- Large filler aperture to facilitate casting
- Resistant to chemical agents
- Resistant to alkaline earth elements
- Stabilized against UV rays
- Longitudinally and transversely watertight
- High electrical insulating values
- High mechanical strength
- Ready for immediate operation
- Quick and easy assembly saves time and reduces costs

Application/Suitability

- Indoor
- Outdoor
- Underground
- Water
- Installation ducts

Voltage level

- U_0/U_m (U_m) 0.6/1 (1.2) kV

Test standards

- DIN EN 50393

Storage conditions/Shelf life

- Cast resin up to 40 months



Dimensions

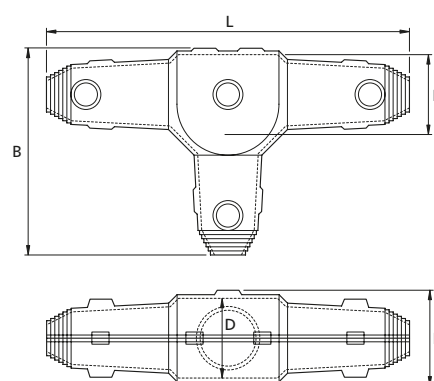

Scope of delivery

Hydrolysis resistance PUR type EG cast resin (containing the correct volume ready for mixing), packed in practical and easy-to-use two-chamber bags, transparent plastic shell, fill and air-release funnels, screw branch clamps, PVC insulation tape, protective gloves, assembly instructions

Optional accessory: Cleaner UNIVERSAL CLEANER 121 (see Accessories)

Type	L mm	B mm	D mm	H mm	Cable-Ø mm		Nominal cross section per conductor mm ²				Art.-No.	
					Main cable	Branch cable	Main cable	Branch cable	Main cable	Branch cable		
												Polymeric cable unarmoured
							4x					
							5x					
T	1 V FKM	240	138	50	60	9-22	9-22	2.5 - 6	1.5 - 6	2.5 - 6	1.5 - 6	436820
	2 V FKM	267	154	60	70	17-30	17-30	4-16	4-16	4-16	4-16	436821
	2.5 V FKM	310	183	75	85	21-37	21-37	6 - 25	6 - 25	6 - 25	6 - 25	436822

**Y...EG****Cast resin branch joint**

for polymeric cables and conductors

Universally suitable for branching polymeric cables or conductors insulated with PVC, PE, XLPE and EPR (e.g. N(A)YY, NYM, TT) with or without concentric conductor. Suitable for branch clamps on copper and aluminium conductors.

Characteristics

- Compact dimensions
- Splice area visible before casting
- High-quality transparent shockproof plastic shell
- Large filler aperture to facilitate casting
- Resistant to chemical agents
- Resistant to alkaline earth elements
- Stabilized against UV rays
- Longitudinally and transversely watertight
- High electrical insulating values
- High mechanical strength
- Ready for immediate operation
- Quick and easy assembly saves time and reduces costs

Application/Suitability

- Indoor
- Outdoor
- Underground
- Water
- Installation ducts

Voltage level

- U_0/U_m 0.6/1 (1.2) kV

Test standards

- DIN EN 50393 (corresponds to VDE 0278)

Storage conditions/Shelf life

- Cast resin up to 40 months

Scope of delivery

Hydrolysis resistance PUR type EG cast resin (containing the correct volume ready for mixing), packed in practical and easy-to-use two-chamber bags, transparent plastic shell, closing stops, fill and air-release funnels, PVC insulation tape, protective gloves, assembly instructions

Optional accessory: Screw branch clamp AK (see Connecting technology)
Branch clamp KP (see Connecting technology)
Branch clamp HE 1/70/150 (see Connecting technology)
Split bolt clamp FK (see Connecting technology)
Cleaner UNIVERSAL CLEANER 121 (see Accessories)

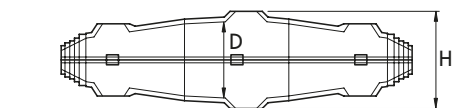
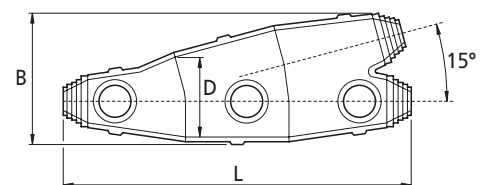
**Dimensions**

Y 0 EG, Y 3.5 EG, Y 6 EG

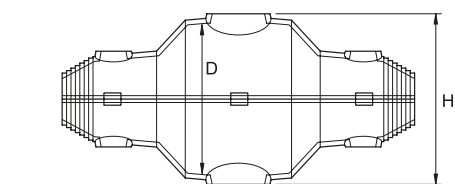
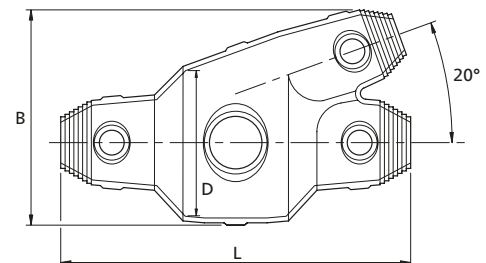

Y 00 EG, Y 1 EG, Y 2 EG, Y 3 EG, Y 4 EG, Y 4.5 EG, Y 5 EG

→ Continued on the next page

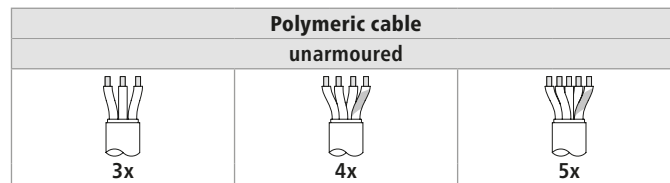

→ Continuation

Y...EG Cast resin branch joint

Type	L mm	B mm	D mm	H mm	max. Cable-Ø mm		max. Nominal cross section per conductor mm ²						Art.-No.
					Main cable	Branch cable	Main cable	Branch cable	Main cable	Branch cable	Main cable	Branch cable	
00 EG	150	75	38	50	19	19	4	2.5	4	2.5	4	2.5	133841
0 EG	185	80	45	55	17	17	6	6	6	6	6	6	152932
1 EG	240	110	60	70	22	22	10	10	10	10	10	10	124730
2 EG	285	120	65	75	34	30	25	25	25	25	25	25	147533
3 EG	240	145	100	110	42	37	50	25	50	35	25	25	131123
3.5 EG	300	150	110	120	54	38	70	25	50	35	35	35	131118
4 EG	285	170	110	120	53	37	95	35	95	50	50	35	124763
4.5 EG	335	193	120	130	56	42	150	70	150	70	120	70	131119
5 EG	382	220	140	150	62	52	240	150	240	95	150	95	157645
6 EG	570	275	180	190	90	80	300	240	300	185	150	150	131126

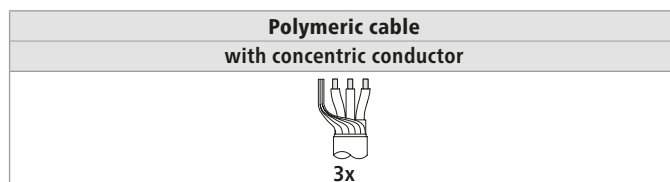

Type	L mm	B mm	D mm	H mm	max. Cable-Ø mm		max. Nominal cross section per conductor mm ²		Art.-No.
					Main cable	Branch cable	Main cable	Branch cable	
00 EG	150	75	38	50	19	19			133841
0 EG	185	80	45	55	17	17	6/6	6/6	152932
1 EG	240	110	60	70	22	22	10/10	10/10	124730
2 EG	285	120	65	75	34	30	16/16	10/10	147533
3 EG	240	145	100	110	42	37	25/25	16/16	131123
3.5 EG	300	150	110	120	54	38	35/35	25/25	131118
4 EG	285	170	110	120	53	37	70/70	25/25	124763
4.5 EG	335	193	120	130	56	42	120/120	95/95	131119
5 EG	382	220	140	150	62	52	150/150	95/95	157645
6 EG	570	275	180	190	90	80	240/120	185/95	131126

**Y...GG****Cast resin branch joint**

for polymeric cables and conductors

Universally suitable for branching polymeric cables or conductors insulated with PVC, PE, XLPE and EPR (e.g. N(A)YY, NYM, TT) with or without concentric conductor. Suitable for branch clamps on copper and aluminium conductors.

Characteristics

- Compact dimensions
- Splice area visible before casting
- High-quality transparent shockproof plastic shell
- Large filler aperture to facilitate casting
- Resistant to chemical agents
- Resistant to alkaline earth elements
- Stabilized against UV rays
- Longitudinally and transversely watertight
- High electrical insulating values
- High mechanical strength
- Ready for immediate operation
- Quick and easy assembly saves time and reduces costs

Application/Suitability

- Indoor
- Outdoor
- Underground
- Water
- Installation ducts

Voltage level

- U_0/U_m 0.6/1 (1.2) kV

Test standards

- DIN EN 50393 (corresponds to VDE 0278)

Storage conditions/Shelf life

- Cast resin up to 24 months

Scope of delivery

Hydrolysis resistance PUR type GG cast resin (containing the correct volume ready for mixing), packed in practical and easy-to-use two-chamber bags, transparent plastic shell, closing stops, fill and air-release funnels, PVC insulation tape, protective gloves, assembly instructions

Optional accessory: Screw branch clamp AK (see Connecting technology)
Branch clamp KP (see Connecting technology)
Branch clamp HE 1/70/150 (see Connecting technology)
Split bolt clamp FK (see Connecting technology)
Cleaner UNIVERSAL CLEANER 121 (see Accessories)

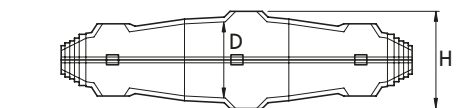
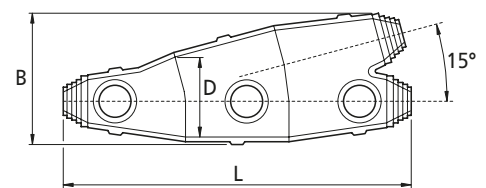
**Dimensions**

Y 0 GG

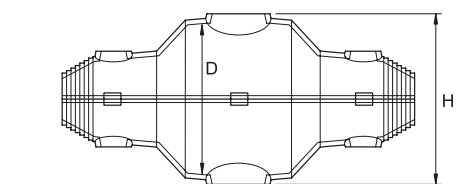
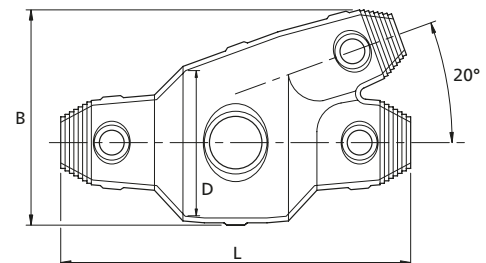

Y 1 GG, Y 2 GG, Y 3 GG, Y 4 GG,

→ Continued on the next page

→ Continuation

Y...GG Cast resin branch joint

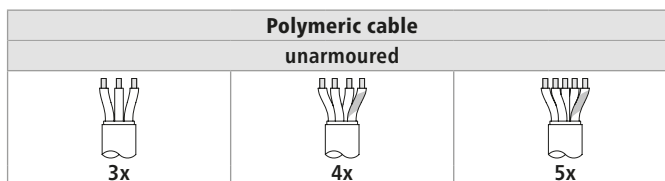

Type	L mm	B mm	D mm	H mm	max. Cable-Ø mm		max. Nominal cross section per conductor mm ²						Art.-No.	
					Main cable	Branch cable	Main cable	Branch cable	Main cable	Branch cable	Main cable	Branch cable		
Y	0 GG	185	80	45	55	17	17	6	6	6	6	6	6	353813
	1 GG	240	110	60	70	22	22	10	10	10	10	10	10	353814
	2 GG	285	120	65	75	34	30	25	25	25	25	25	25	353815
	3 GG	240	145	100	110	42	37	50	25	50	35	25	25	353816
	4 GG	285	170	110	120	53	37	95	35	95	50	50	35	353817

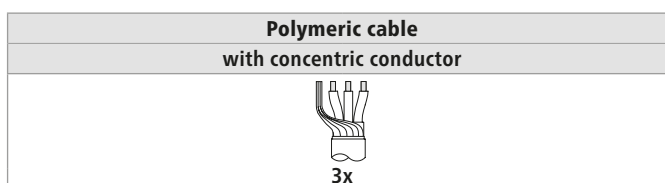

Type	L mm	B mm	D mm	H mm	max. Cable-Ø mm		max. Nominal cross section per conductor mm ²		Art.-No.	
					Main cable	Branch cable	Main cable	Branch cable		
Y	0 GG	185	80	45	55	17	17	6/6	6/6	353813
	1 GG	240	110	60	70	22	22	10/10	10/10	353814
	2 GG	285	120	65	75	34	30	16/16	10/10	353815
	3 GG	240	145	100	110	42	37	25/25	16/16	353816
	4 GG	285	170	110	120	53	37	70/70	25/25	353817



Y...V FKM

Cast resin branch joint

with split bolt branch clamps, for polymeric cables and conductors

Universally suitable for branching polymeric cables or conductors insulated with PVC, PE, XLPE and EPR (e.g. N(A)YY, NYM). With one-core branch clamps, suitable for copper and aluminium conductors.

Characteristics

- Compact dimensions
- Splice area visible before casting
- High-quality transparent shockproof plastic shell
- Large filler aperture to facilitate casting
- Resistant to chemical agents
- Resistant to alkaline earth elements
- Stabilized against UV rays
- Longitudinally and transversely watertight
- High electrical insulating values
- High mechanical strength
- Ready for immediate operation
- Quick and easy assembly saves time and reduces costs

Application/Suitability

- Indoor
- Outdoor
- Underground
- Water
- Installation ducts

Voltage level

- U_0/U_m (U_m) 0.6/1 (1.2) kV

Test standards

- DIN EN 50393

Storage conditions/Shelf life

- Cast resin up to 40 months

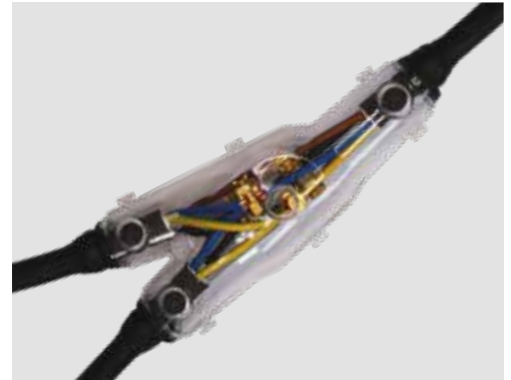

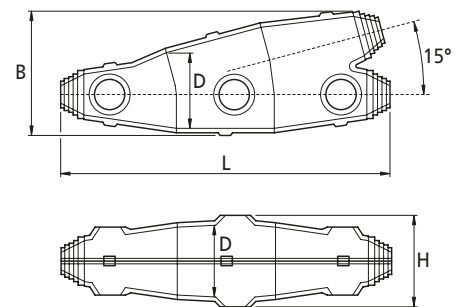

Dimensions



Scope of delivery

Hydrolysis resistance PUR type EG cast resin (containing the correct volume ready for mixing), packed in practical and easy-to-use two-chamber bags, transparent plastic shell, closing stops, fill and air-release funnels, screw branch clamps, PVC insulation tape, protective gloves, assembly instructions

Optional accessory: Cleaner UNIVERSAL CLEANER 121 (see Accessories)

Polymeric cable	
unarmoured	
 4x	 5x

Type	L mm	B mm	D mm	H mm	max. Cable-Ø mm		Nominal cross section per conductor mm ²				Art.-No.	
					Main cable	Branch cable	Main cable	Branch cable	Main cable	Branch cable		
Y	0 V FKM	185	80	45	55	8 - 17	8 - 17	2.5 - 4	1.5 - 4	2.5 - 4	1.5 - 4	436823
	1 V FKM	240	110	60	70	9 - 22	9 - 22	2.5 - 6	1.5 - 6	2.5 - 6	1.5 - 6	436824
	2 V FKM	285	120	65	75	19 - 34	16 - 30	4-16	4-16	4-16	4-16	436825

LOW VOLTAGE
Cast resin technology



YCP

Cast resin branch joint

for polymeric cables and conductors

Suitable for branching the 1-core cables or conductors, e.g. wires for cathodic corrosion protection from chemical and electrochemical reactions in underground area and under water. Pipes, warehouse containers, electric supply lines and other metal constructions are economically and effectively protected against passive corrosion (polymeric casings, mastic glass fibre casings). Suitable for branch clamps on copper and aluminium conductors.

Characteristics

- Compact dimensions
- Splice area visible before casting
- High-quality transparent shockproof plastic shell
- Large filler aperture to facilitate casting
- Resistant to chemical agents
- Resistant to alkaline earth elements
- Stabilized against UV rays
- Longitudinally and transversely watertight
- High electrical insulating values
- High mechanical strength
- Ready for immediate operation
- Quick and easy assembly saves time and reduces costs

Application/Suitability

- Indoor
- Outdoor
- Underground
- Water
- Installation ducts

Voltage level

- U_0/U_m 0.6/1 (1.2) kV

Test standards

- DIN EN 50393 (corresponds to VDE 0278)

Storage conditions/Shelf life

- Cast resin up to 40 months



Dimensions

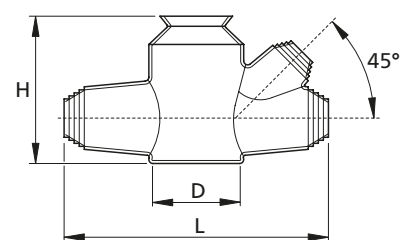

Scope of delivery

Hydrolysis resistance PUR type EG cast resin (containing the correct volume ready for mixing), packed in practical and easy-to-use two-chamber bags, transparent plastic shell, closing stops, PVC insulation tape, protective gloves, assembly instructions

Optional accessory: Screw branch clamp AK (see Connecting technology)
Split bolt clamp FK (see Connecting technology)
Cleaner UNIVERSAL CLEANER 121 (see Accessories)

Type	L mm	B mm	D mm	H mm	max. Cable-Ø mm		Nominal cross section per conductor mm ²		Art.-No.
					Main cable	Branch cable	Main cable	Branch cable	
YCP	135	48	44	75	23	20	10 - 50	4 - 50	124683



D1

Cast resin branch / straight-through joint

particularly for small cross sections for polymeric cables and conductors, control cables and signal cables

The parallel-branch joint (dual connection joint) is suitable for branching polymeric cables or conductors mainly used for 1-core special cables for airport runways lighting. Suitable for compression connectors on copper conductors.

Characteristics

- Compact dimensions
- Splice area visible before casting
- High-quality transparent shockproof plastic shell
- Large filler aperture to facilitate casting
- Resistant to chemical agents
- Resistant to alkaline earth elements
- Stabilized against UV rays
- Longitudinally and transversely watertight
- High electrical insulating values
- High mechanical strength
- Ready for immediate operation
- Quick and easy assembly saves time and reduces costs

Application/Suitability

- Indoor
- Outdoor
- Underground
- Water
- Installation ducts

Voltage level

- U_0/U_m 0,6/1 (1,2) kV - 5KV DC

Test standards

- DIN EN 50393 (corresponds to VDE 0278)

Storage conditions/Shelf life

- Cast resin up to 40 months



Dimensions

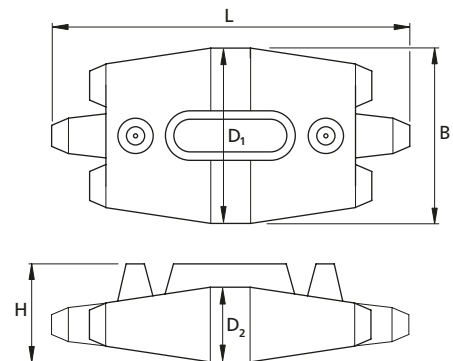

Scope of delivery

Cover, hydrolysis resistance PUR type EG cast resin (containing the correct volume ready for mixing), packed in practical and easy-to-use two-chamber bags, transparent plastic shell, PVC insulation tape, protective gloves, assembly instructions

Optional accessory: Compression connectors (see Connecting technology)
Cleaner UNIVERSAL CLEANER 121 (see Accessories)

							Polymeric cable			
							unarmoured			
							1x	4x		
Type	L mm	B mm	D1 mm	D2 mm	H mm	max. Cable-Ø mm	Nominal cross section per conductor mm ²		Art.-No.	
D1	185	90	84	30	48	16	6	2.5	124685	

							Control and signal cable					
							0.6 mm	0.8 mm	0.75 mm ²	1.5 mm ²		
Type	L mm	B mm	D1 mm	D2 mm	H mm	max. Cable-Ø mm	Number of wire pairs		Number of conductors		Art.-No.	
D1	185	90	84	30	48	16	6 - 10	6 - 6	6	4	124685	

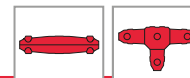

M1, T1 and Y1

Cast resin straight-through and branch joints

with WAGO COMPACT Splicing Connectors of the series 221, for polymeric cables

Universally suitable for connecting polymeric cables or conductors insulated with PVC, PE and XLPE (e.g. N(A)YY, NYM, TT). Suitable for copper cables.

Characteristics

- High-quality transparent shockproof plastic shell
- With WAGO COMPACT Splicing Connectors of the series 221
- Quick and easy assembly saves time and reduces costs
- Ready for immediate operation
- Durable protection from moisture / waterproof
- Splice area visible before casting
- Compact dimensions of the joint
- Large filler aperture to facilitate casting
- Resistant to chemical agents
- Resistant to alkaline earth elements
- Stabilized against UV rays
- Longitudinally and transversely watertight
- High electrical insulating values
- High mechanical strength
- Not harmful to the environment

Application/Suitability

- Outdoor applications
- Interiors with high humidity exposure
- Public buildings, Underground and outdoor

Voltage level

- U_0/U_m 0,6/1 (1,2) kV

Test standards

- DIN EN 50393

Storage conditions/Shelf life

- Cast resin up to 40 months



Dimensions M1

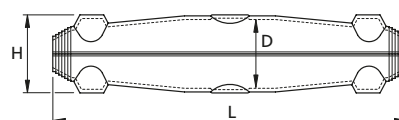

Dimensions T1

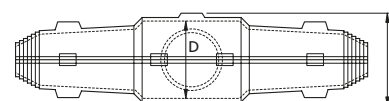
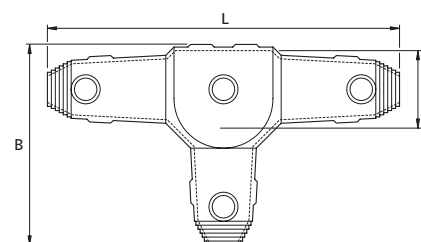

Dimensions T1

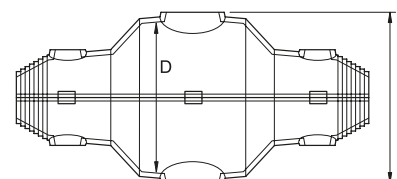
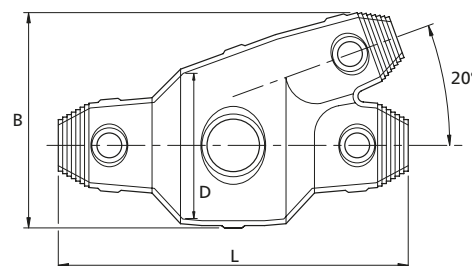

WAGO | inside

Scope of delivery

Cover, hydrolysis resistance PUR type EG cast resin (containing the correct volume ready for mixing), packed in practical and easy-to-use two-chamber bags, WAGO COMPACT Splicing Connectors of the series 221 (T1 and Y1: Type 221 - 413, M1: Type 221 - 2411), transparent plastic shell, PVC insulation tape, protective gloves, funnel clips, assembly instructions

Optional accessory: Funnel set/Filling in funnel (on request)
Heat shrinkable crimp connector (see Connecting technology)
Cleaner UNIVERSAL CLEANER 121 (see Accessories)



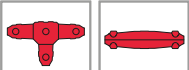

→ Continued on the next page



→ Continuation

M1, T1 and Y1 Cast resin straight-through and branch joints

LOW VOLTAGE
Cast resin technology

Type	Shell Type	WAGO COMPACT-Splicing connector  5 x 221-413	Single, fine or multi-stranded conductors mm ²	max. Cable-Ø mm		min. Cable-Ø mm		EG cast resin ml	Art.-No.
				Main cable	Branch cable	Main cable	Branch cable		
T1 WAGO	T1	 5 x 221-413	0,5 - 4	22	22	9	9	464	425469
Y1 WAGO	Y1	 5 x 221-413	0,5 - 4	22	22	9	9	464	425490
M1 WAGO	M1	 5 x 221-2411	0,5 - 2,5* 0,5 - 4	22	-	9	-	286	425491

* With stranded conductors

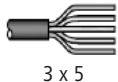
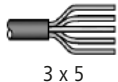
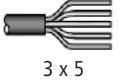
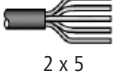
Type	L mm	B mm	D mm	H mm	Max. possible Number of conductors	Number of Cable inputs x Cable/conductor  3 x 5	Assignment with WAGO COMPACT Splicing Connectors	
							221-413	221-2411
T1	240	138	50	60	15	 3 x 5	5	-
Y1	240	110	60	70	15	 3 x 5	5	-
M1	240	-	40	45	10	 2 x 5	-	5



Universal Box CG WAGO Connection and branch box

OBO cable junction box with WAGO COMPACT type 221 splicing connectors, the cast resin does not require a hazard label

The Universal Box CG combines the advantages of a junction and branch box with those of resin cable accessories. It is universally suitable for implementing complex electrical connections in the tightest of spaces.

The system ensures permanent protection against moisture and completely eliminates condensation.

Properties

- High-quality cable junction boxes from OBO BETTERMANN available in various housing sizes
- Fitted with WAGO COMPACT 221 series splicing connectors
- Protection class: IP68 with cast resin
- Halogen-free
- UV-resistant junction box
- CMR, isocyanate and silicone-free, no hazard label required
- Environmentally compatible
- High flexibility thanks to removable cast resin
- Translucent, even after hardening
- Durability, even when exposed to permanent moisture

Application/suitability

- Indoor areas (also with high exposure to moisture)
- Outdoor
- Earth

Voltage level

- 230/400 V

Test standards

- DIN EN 60529 (VDE 0470)
- DIN EN 50393 (VDE 0278)

Storage time/shelf life

- Cast resin up to 24 months



Dimensions

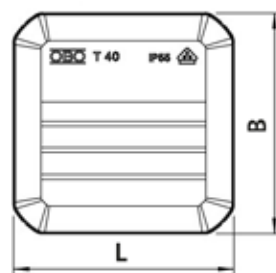
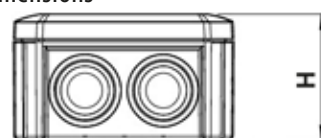

WAGO | inside

Scope of delivery

2-component hydrocarbon resin CG, measured out in a practical two-chamber mixing bag so that it is ready to mix, high-quality cable junction box from OBO BETTERMANN, WAGO COMPACT 221 series splicing connectors, funnel for convenient vertical casting, emery cloth and installation instructions

Optional accessories: UNIVERSAL CLEANER 121 (see accessories)

Note: Cast resin CG can be reordered for refilling.

Type	OBO BETTERMANN cable junction box	WAGO COMPACT splicing connectors	Nominal cross-section per core mm ²	Cast resin does not require a hazard label ml	Art.-no.
Universal Box CG	T40	T40	5 x 221-413	0,14f / 0,2 - 4	425589
	T60	T60	5 x 221-613	0,5 - 6	428123
	T100	T100	5 x 221-615	0,5 - 6	428124

Technical data	OBO BETTERMANN cable junction box type		
	T40	T60	T100
Dimension (LxBxH) mm			
inside	77x77x46	100x100x48	136x102x57
outside	90x90x52	114x114x57	150x116x67
Entry point	7 x M20	7 x M20	10 x M20
Cover catch	Snap closure	Screw cap	Screw cap



Universal Box CG Connection and branch box

with clamps and non-labelled cast resin

The connection and branch box combines the advantages of a traditional box with the well-known professional cast resin technology. Complex connections in a very small volume can be done with this universal box. The system guarantees an absolute waterproof protection, excluding all condensation risks.

Characteristics

- OBO BETTERMANN T40 branch box with plug-in seal
- Practical connection and branch box with 7 x M20 membran entries
- Protection class: IP68 with cast resin
- Halogen Free
- UV-resistant branch box
- 5-pole clamps for conductor crosssections of 0.5 - 2.5 mm²
- Free hazardous labelling (isocyanate and silicon free)
- Not harmful to the environment
- High flexibility due to removable cast resin
- Translucent before and after curing
- Cable retaining rings for additional stabilisation of the cable
- Withstands long-term exposure to moisture

Application/Suitability

- Outdoor
- Indoor areas (also with high humidity level)
- Underground

Voltage level

- 230/400 V

Test standards

- DIN EN 60529 (VDE 0470)
- DIN EN 50393 (VDE 0278)

Storage conditions/Shelf life

- Cast resin up to 24 months

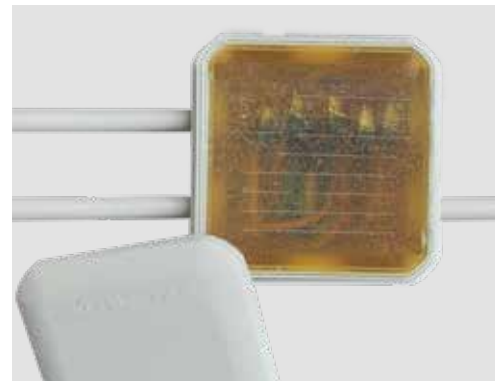

Dimensions

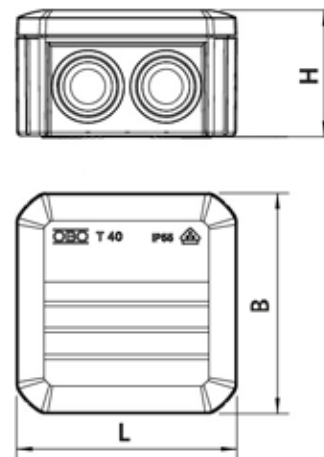

Scope of delivery

250 ml 2-component hydrocarbon resin CG (containing the correct volume ready for mixing), packed in practical and easy-to-use two-chamber bags, box with membran entries, 5 clamps 5-pole 0.5 - 2.5 mm², 12 cable retaining rings CP-Z1, funnel for easy vertical filling, emery cloth, assembly instructions

Optional accessory: Cleaner UNIVERSAL CLEANER 121 (see Accessories)

Note: Type CG cast resin refills may be ordered separately.

Type	L mm	B mm	H mm	max. Cable-Ø mm	Polymeric cable unarmoured		Art.-No.
					Nominal cross section per conductor mm ²		
Universalbox CG	250 ml	90	90	52	20	0,5 - 2,5	420083



EG

Two-component PUR cast resin

universal

Cast resin EG is suitable for the following types of cables: Low voltage polymeric-insulated and mass-impregnated paper cables up to 1 kV, polymeric-insulated and mass-impregnated paper telecommunication and signal cables and medium voltage cables (as mechanical protection and protection against moisture).

Characteristics

- Two-component PUR cast resin
- In practical and easy-to-use two-chamber bags
- Favourable flow properties
- High hydrolysis resistance
- Resistant to alkaline earth elements
- Halogen-free
- Not harmful to the environment
- Flexibility ensures mechanical stress absorption
- No fracturing under electrical stress
- No fracturing under mechanical tension
- Excellent adhesion to all cable materials
- Low hardening temperature

Test standards

- DIN VDE 0278-631-1

Storage conditions/Shelf life

- In aluminium bag 40 months at ambient temperatures between 15 °C and 35 °C



Scope of delivery

1 PU

Note: Other sizes available on request.

Type	Content ml	Art.-No.
80	80	134999
143	143	124909
286	286	124986
370	370	124962
464	464	124989
730	730	124990
1000	1000	124992
1150	1150	124901
1500	1500	124991
2000	2000	132206

→ Continued on the next page

→ Continuation

EG Two-component PUR cast resin

Technical data	Value
Flash point of cast resin component (open cup)	> 200 °C
Flash point of reactant (open cup)	> 200 °C
Processing time (pot life) of 300 ml mixture at	
5 °C	40 minutes
23 °C	23 minutes
35 °C	15 minutes
max. Reaction temperature	80 °C
Total volume shrinkage during curing	4.0 %
Density	1.10 g/cm ³
Impact strength	> 10 kJ/m ²
Hardness	55 Shore D
Water absorption in warm water (42 d at 50 °C)	350 mg
Electrolytic corrosion	A 1
1 minute test voltage at	
23 °C	> 20 kV
80 °C	> 20 kV
Dielectric dissipation factor at	
23 °C and 1 kHz	0.05
23 °C and 50 Hz	0.08
Dielectric constant at	
23 °C and 1 kHz	5.3
23 °C and 50 Hz	5.1
Tracking resistance	KA 3c
Operating temperature range	-40 °C up to +105 °C



GG

Two-component PUR cast resin

reduced hazard-class, diisocyanates training is not required

Cast resin GG is a special development to fulfill reduced hazard-classification. It's labelling identification, according to the CLP-Regulation (EC) No. 1272/2008, does not contain the H351 statement. The cast resin GG has similar properties as the known polyurethane cast resins. Cast resin GG is suitable for low voltage polymeric-insulated and mass-impregnated paper cables up to 1 kV.

Characteristics

- Two-component PUR cast resin
- In practical and easy-to-use two-chamber bags
- Favourable flow properties
- High hydrolysis resistance
- Resistant to alkaline earth elements
- Halogen-free
- Not harmful to the environment
- Flexibility ensures mechanical stress absorption
- No fracturing under electrical stress
- No fracturing under mechanical tension
- Excellent adhesion to all cable materials
- Low hardening temperature
- Reduced hazardous labelling identification according to the CLP-Regulation (EC) No. 1272/2008

Test standards

- DIN VDE 0278-631-1
- #### Storage conditions/Shelf life
- In aluminium bag 24 months at ambient temperatures between 15 °C and 35 °C



Scope of delivery

1 PU

Note: Other sizes available on request.

Type	Content ml	Art.-No.
80	80	353869
143	143	353890
286	286	353891
370	370	353892
464	464	353893
730	730	353894
1000	1000	353818
1700	1700	335750

Technical data	Value
Flash point of cast resin component (open cup)	> 200 °C
Flash point of reactant (open cup)	> 200 °C
Processing time (pot life) 300 ml mixture at	
5 °C	68 minutes
23 °C	24 minutes
35 °C	15 minutes
max. Reaction temperature	60 °C
Total volume shrinkage during curing	< 6.0 %
Density	1.32 g/cm ³
Impact strength	> 10 kJ/m ²
Hardness	30 Shore D
Operating temperature range	-40 °C up to +90 °C

**CG****Two-component hydrocarbon resin**

non-labelled, free of silicone and isocyanate

Cast resin CG is an environment-friendly and removable 2-component cold curing casting compound based on hydrocarbon resins which does not require hazardous label acc. to CLP-Regulation (EC) No. 1272/2008. The translucent cast resin allows a visual inspection even after the casting. The connection is accessible at any time by removing the cast resin. Typical application areas: cable branch-off cabinet, connection boxes, telecommunication cable connections, electronic components.

Characteristics

- Two-component hydrocarbon cast resin
- In practical and easy-to-use two-chamber bags
- Exceptional electrical insulation
- Free hazardous labelling identification according to the CLP-Regulation (EC) No. 1272/2008
- Free of isocyanate and silicon
- Removable
- Translucent before and after curing
- Favourable flow properties
- Low volume shrinkage
- Cold curing (no heat during reaction)
- Halogen free
- No fracturing under electrical stress
- Excellent adhesion to all cable materials

Note

- Due to its soft elastic mechanical properties, which are favourable for removal, it is advised to implement a cable relief, if stresses on the cable are likely to occur.

Test standards

- DIN EN 60455-3-8
- DIN EN 50655-1

Storage conditions/Shelf life

- In aluminium bag 24 months at ambient temperatures between 15 °C and 30 °C

**Scope of delivery**

1 PU

Note: Other sizes available on request.

Type	Content ml	Art.-No.
CG	143	362398
	250	362399
	275	434565
	420	434566
	730	362410
	1000	363564
	2000	362411

Technical data*	Value	Test standard
Processing time (pot life) 300 ml mixture at 5 °C	24 minutes	DIN EN 60455-2
23 °C	21 minutes	
40 °C	16 minutes	
Hardness (PEN/Hardness)	57 1/10 mm	DIN ISO 2137
Resin - Viscosity at 23°C	2010 mPa x s	EN ISO 2555
Hardener - Viscosity at 23°C	7500 mPa x s	EN ISO 2555
Mix viscosity 5 minutes after mixing at 23°C	4200 mPa x s	EN ISO 2555
Density cured casting compound	0,92 g/cm ³	EN ISO 1183-1
Resistance to electrical breakdown	> 25 kV/mm	DIN EN 60243-1
Volume resistance at 23°C	> 10 ¹⁴ Ωcm	DIN IEC 60093
Storage temperature	0 - 40 °C	DIN EN 60455-2
Operating temperature range	< 80 °C	DIN EN 60455-2

*The given values are typical values and not a specification



FG

Two-component PUR cast resin

flexible

Cast resin FG is suitable for repairing damaged cable-sheaths and for connecting flexible cables. It provides an excellent resistance to abrasion.

Characteristics

- Two-component PUR cast resin
- In practical and easy-to-use two-chamber bags
- Favourable flow properties
- High hydrolysis resistance
- Halogen-free
- Not harmful to the environment
- Resin remains highly flexible after hardening
- Flexibility ensures mechanical stress absorption
- No fracturing under electrical stress
- No fracturing under mechanical tension
- Excellent adhesion to all cable materials
- Low hardening temperature

Test standards

- DIN VDE 0278-631-1

Storage conditions/Shelf life

- In aluminium bag 24 months at ambient temperatures between 15 °C and 35 °C



Scope of delivery

1 PU

Note: Other sizes available on request.

Type	Content ml	Art.-No.
FG	143	135534
	286	125153
	464	125154
	1000	125155

Technische Daten	Wert
Gießharzkomponenten: Flammpunkt im offenen Tiegel	> 200 °C
Reaktionsmittel: Flammpunkt im offenen Tiegel	> 200 °C
Verarbeitungszeit (Topfzeit) 300 ml Ansatz	
5 °C	21 Minuten
23 °C	17 Minuten
35 °C	12 Minuten
Max. Reaktionstemperatur	60 °C
Gesamtvolumenschwund bei der Härtung	6,0 %
Dichte	1,10 g/cm ³
Härte	50 Shore A
Reißdehnung	250 %
Wasseraufnahme in warmen Wasser (42 d bei 50 °C)	600 mg
1 Minute Prüfspannung bei	
23 °C	> 20 kV
80 °C	> 10 kV
Dielektrischer Verlustfaktor bei	
23 °C und 50 Hz	0,20
50 °C und 50 Hz	1,40
Dielektrizitätskonstante bei	
23 °C und 50 Hz	7,4
50 °C und 50 Hz	8,9
Kriechstromfestigkeit	KA 3c



UG

Two-component PUR cast resin

flame retardant

Cast resin UG meets the higher fire protection requirements and was specially developed for use in mining. It meets the requirements for cast resin moulding according to DIN VDE 0291 Section 2 on filling the cable sets or parts thereof for the following types of cables: Power cables with a nominal voltage up to 1 kV - GNH, power cables with a nominal voltage up to 10 kV - GMH and telecommunication and signal cables - GFH.

Characteristics

- Two-component PUR cast resin
- In practical and easy-to-use two-chamber bags
- Favourable flow properties
- Fast-hardening
- High hydrolysis resistance
- Resistant to chemical agents
- Resistant to alkaline earth elements
- Halogen-free
- Flame retardant
- Not harmful to the environment
- Low smoke emission in case of fire
- No fracturing under electrical stress
- No fracturing under mechanical tension
- Excellent adhesion to all cable materials

Test standards

- Flame retardation in accordance with DIN VDE 0472 Section 804, test typ C
- Properties of insulation against flames in accordance with DIN VDE 0472 Section 814
- Corrosiveness of combustion gases in accordance with DIN VDE 0472 Section 813
- DIN VDE 0278-631-1

Storage conditions/Shelf life

- In aluminium bag 24 months at ambient temperatures between 15 °C and 35 °C



Scope of delivery

1 PU

Note: Other sizes available on request.

Type	Content ml	Art.-No.
80	80	125286
143	143	125287
286	286	125288
UG 464	464	125289
730	730	125290
1000	1000	125291
2000	2000	135533

→ Continued on the next page



→ Continuation

UG Two-component PUR cast resin

Technical data	Value
Flash point of cast resin component (open cup)	> 200 °C
Flash point of reactant (open cup)	> 200 °C
Processing time (pot life) 300 ml mixture at	
5 °C	23 minutes
23 °C	16 minutes
35 °C	12 minutes
max. Reaction temperature	78 °C
Total volume shrinkage during curing	2.5 %
Density	1.40 g/cm ³
Impact strength	> 20 kJ/m ²
Hardness	80 Shore D
Water absorption in warm water (42 d at 50 °C)	250 mg
Water absorption in cold water (24 h at 23 °C)	18 mg
Electrolytic corrosion	A 1.2
1 minute test voltage at	
23 °C	38 kV
80 °C	35 kV
Dielectric dissipation factor at	
23 °C and 1kHz	0.02
23 °C and 50 Hz	0.03
50 °C and 50 Hz	0.06
80 °C and 50 Hz	0.15
Dielectric constant at	
23 °C and 1 kHz	4.1
23 °C and 50 Hz	4.3
50 °C and 50 Hz	5.5
80 °C and 50 Hz	7.2
Tracking resistance	KA 3c

**UWR****Two-component PUR cast resin**

low reactivity to water

Cast resin UWR has been specially developed for filling the cable joints exposed to high levels of humidity. It is characterised by its resistance to water in the liquid and in the solid state and is suitable for the encapsulation which are exposed to high levels of humidity for the following cable types: low voltage polymeric-insulated and mass-impregnated paper cables up to 1 kV

Characteristics

- Two-component PUR cast resin
- In practical and easy-to-use two-chamber bags
- Favourable flow properties
- High hydrolysis resistance
- Halogen-free
- Not harmful to the environment
- No fracturing under electrical stress
- No fracturing under mechanical tension
- Excellent adhesion to all cable materials

Test standards

- DIN VDE 0278-631-1

Storage conditions/Shelf life

- In aluminium bag 24 months at ambient temperatures between 15 °C and 35 °C

**Scope of delivery**

1 PU

Note: Other sizes available on request.

Type	Content ml	Art.-No.
UWR	143	139163
	464	148876
	1175	137406
	1350	137358
	2000	137877

Technical data	Value
Flash point of cast resin component (open cup)	140 °C
Processing time (pot life) 300 ml mixture at	
5 °C	30 minutes
23 °C	15 minutes
35 °C	8 minutes
max. Reaction temperature	88 °C
Total volume shrinkage during curing	4.2 %
Density	1,20 g/cm ³
Impact strength	> 28 kJ/m ²
Hardness	60 Shore D
Elongation at break	40 %
Effect of long-term warm storage on impact strength (38 d)	15 kJ/m ²
Tear resistance	16 N/mm ²
Tensile strength	15 N/mm ²
Residual deformation (after 24 h)	0,4 %
Pressure required for 30 % deformation	27 N/mm ²
Curing under water	< 10 ml glass
Hydrolysis resistance after water immersion (28 d at 70 °C)	passed
Physical structure	passed (homogeneous and bubble-free)



WG

Two-component PUR cast resin

removable

The unfilled thin two-component polyurethane cast resin (PUR) WG was particularly developed for cable joints. The hardened moulding material is permanently elastic and can be removed at any time with simple tools.

Characteristics

- Two-component PUR cast resin
- In practical and easy-to-use two-chamber bags
- Favourable flow properties
- High hydrolysis resistance
- Halogen-free
- Not harmful to the environment
- No fracturing under electrical stress
- Excellent adhesion to all cable materials
- Low hardening temperature
- Permanently flexible after hardening

Note

- Connection requires mechanical tension relief due to the flexibility of the resin e.g. by means of a mechanically stable joint housing.

Test standards

- DIN VDE 0278-631-1

Storage conditions/Shelf life

- In aluminium bag 18 months at ambient temperatures between 15 °C and 35 °C



Scope of delivery

1 PU

Note: Other sizes available on request.

Type	Content ml	Art.-No.
WG	286	125202
	464	125203
	730	125204
	1000	125205
	1150	125206
	1500	125207
	2000	125208
	2200	125209

Technical data	Value
Flash point of cast resin component (open cup)	200 °C
Flash point of reactant (open cup)	200 °C
Processing time (pot life) 300 ml mixture at	
5 °C	33 minutes
23 °C	24 minutes
35 °C	21 minutes
max. Reaction temperature	60 °C
Total volume shrinkage during curing	1,2 %
Density	1,10 g/cm ³
Hardness	44 Shore A
Elongation at break	60 %
Tensile strength	0,6 N/mm ²
Tracking resistance	KA 3c
Water absorption in warm water (42 d at 50 °C)	450 mg
Electrolytic corrosion	A 1,2
1 minute test voltage at	
23 °C	> 20 kV
80 °C	> 10 kV
Dielectric dissipation factor at 23 °C and 50 Hz	0,04
Dielectric constant at 23 °C and 50 Hz	5,7

**AMX-C****Automatic cast resin mixing system**

with static mixer

Cartridge filled with two-component PUR cast resin for easy casting of connection and branch boxes and cast resin joints in a single operation without time-consuming preparation of cast resin components. Suitable for low voltage polymeric-insulated cables up to 1 kV; ideal for boxes with smaller volume.

Characteristics

- Mixing and casting in one step
- Less workload as no preparatory work such as kneading is necessary
- Safe and automatic mixing of cast resin components during application
- Favourable flow properties for clean application and precise dosing
- Individually dosable
- Reclosable cartridge for multiple use
- Resistant to alkaline earth elements
- Stabilized against UV rays
- Halogen-free
- Not harmful to the environment
- No fracturing under electrical stress
- Excellent adhesion to all cable materials
- No fracturing under mechanical tension
- Low hardening temperature

Application/Suitability

- Indoor
- Outdoor
- Underground
- Connection and branch boxes
- Cast resin joints

Voltage level

- $U_0/U_m (U_m)$ 0.6/1 (1.2) kV

Test standard

- DIN VDE 0278-631-1

Storage conditions/Shelf life

- 24 months at ambient temperatures between 15 °C and 35 °C

Note on multiple use:
Clean cartridge opening and (cartridge) cap after use.
Replace static mixer.

**Scope of delivery**

Cast resin cartridge, static mixer

Note: Static mixer can be ordered separately or as part of the AMX cleaning accessory kit (static mixer, cleaning tissue and gloves).





Optional accessory: Caulking gun AMX-HPT 310 (see Accessories)
Caulking gun AMX-HPT 1200 (see Accessories)
Accu caulking gun AMX-APT 310 (see Accessories)

Typ	Content ml	Art.-No.
AMX-C265-EGK	265	292688
AMX-1200-EGK	1200	249007

Technical data	Value
Density	1.11 g/cm ³
Hardness	50 Shore D
Tensile strength	13 N/mm ²
Elongation at break	60 %
Viscosity (20 °C)	1700 mPa x s
Operating temperature range	-40 °C up to +105 °C

LOW VOLTAGE

Gel technology

	Gelboxes	114
	Straight-through joints	118
	Branch joints	122
	Casting compounds	123

**EASY-PROTECT****Gel box**

with WAGO COMPACT Splicing Connectors

Gel filled housings for easy, fast and safe moisture protection of WAGO COMPACT Splicing Connectors

Characteristics

- Protects the splicing connector against moisture and water ingress according to IPX8
- VDE type-tested system according to EN 60998-2 for approval in conjunction with WAGO COMPACT Splicing Connectors 221
- Rigid, label-free and silicone-free gel
- UV-resistant housing, robust and re-accessible housing
- Fast application, easy mounting and direct commissioning
- Ready to use and immediately operational

Application/Suitability

- Indoor and Outdoor
- Can be used in the low-voltage range without an additional housing
- Can be used in the low-voltage range with additional housing (double insulation / observe protection class II)

Note

- Not reusable

Voltage level

- $U_o/U (U_m)$ 0,6/1 (1,2) kV

Test standards

- VDE type-tested system according to EN 60998-2

Storage conditions/Shelf life

- Unlimited shelf life at ambient temperature between 0 °C und 40 °C

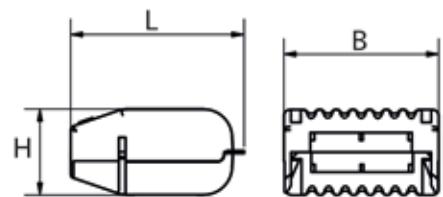
**Dimensions****WAGO** | inside**Scope of delivery**

pre-filled gel box, WAGO COMPACT Splicing Connector type 221



Assignment with WAGO COMPACT Splicing Connectors, type 221

Designation	L mm	B mm	H mm	Assignment with WAGO COMPACT Splicing Connectors, type 221					
				221-412	221-413	221-415	221-612	221-613	221-615
Size 1	33,6	32,0	17,8	1	1	-	-	-	-
Size 2	33,6	45,9	17,8	2	-	1	-	-	-
Size 3	33,6	52,7	17,8	3	2	-	-	-	-
Size 4	40,1	38,0	21,3	-	-	-	1	1	-
Size 5	40,1	49,4	21,3	-	-	-	2	-	1
Size 6	40,1	66,4	21,3	-	-	-	3	2	-

Typ	Housing size	Type WAGO COMPACT Splicing Connector	Nominal cross section mm ²	Number of Gel boxes	Art.-No.
EASY-PROTECT	112	1 x 221-412	0,14 f / 0,2 - 4 mm ²	1	407858
	113	1 x 221-413		1	407859
	222	2 x 221-412		1	407860
	215	1 x 221-415		1	407861
	332	3 x 221-412		1	407862
	323	2 x 221-413		1	407863
	412	1 x 221-612	0,5 - 6 mm ²	1	410356
	413	1 x 221-613		1	410357
	522	2 x 221-612		1	410358
	515	1 x 221-615		1	410359
	632	3 x 221-612		1	410360
	623	2 x 221-613		1	410361
EASY-PROTECT Bulk	113	12 x 221-413	0,14 f / 0,2 - 4 mm ²	12	451511
	332	48 x 221-412		16	451512
	323	24 x 221-413		12	451513

→ Continued on the next page

WAGO is a registered trademark of WAGO Verwaltungsgesellschaft mbH



→ Continuation

EASY-PROTECT Gel box

Technical data	Value	Test standard
Physical properties		
IP protection class	IPX8	EN 60529
Storage period	Indefinite storage capacity	-
Housing colour	Black	-
Housing material	Polypropylene	-
Closure type	Latching	-
Wiring direction	One-sided	-
Gel colour	Translucent amber	-
Gel material	Polyurethan	-
Thermodynamic properties		
Continuous service temperature	105 °C	EN 60998-2
Ambient temperature (operation)	85°C according to T85 marking	EN 60998-2
Working temperature / Storage temperature	0 - 40 °C	
Flammability class housing	V2*	UL 94
Electrical properties**		
Voltage range	450 V	EN 60998-2
Rated surge voltage	4 kV	EN 60998-2
Rated current	32 A respectively 41 A (WAGO COMPACT Splicing Connectors)	EN 60998-2
Resistance to electrical breakdown gel	≥ 15 kV / mm	EN 60243-1

* Approximately comparable to the glow wire test according to EN 60695

** Double insulation / observe protection class II for low voltage



EASY-PROTECT INLINE

Gel box

with WAGO COMPACT-Inline Splicing connectors with lever

Gel filled housings for easy, fast and safe moisture protection of WAGO COMPACT-Inline Splicing Connectors with lever

Characteristics

- Protects the splicing connector against moisture and water ingress according to IPX8
- VDE type-tested system according to EN 60998-2 for approval in conjunction with WAGO COMPACT-Inline Splicing Connectors with lever type 221
- Rigid, label-free and silicone-free gel
- UV-resistant housing, robust and re-accessible housing
- Fast application, easy mounting and direct commissioning
- Ready to use and immediately operational

Application/Suitability

- Indoor and Outdoor
- Can be used in the low-voltage range without an additional housing
- Can be used in the low-voltage range with additional housing (double insulation / observe protection class II)

Note

- Not reusable

Voltage level

- U_o/U_{m} 0,6/1 (1,2) kV

Test standards

- VDE type-tested system according to EN 60998-2

Storage conditions/Shelf life

- Unlimited shelf life at ambient temperature between 0 °C und 40 °C



Dimensions

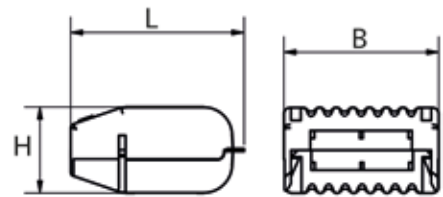

WAGO | inside

Scope of delivery

pre-filled gel box, WAGO COMPACT-Inline Splicing Connector with lever type 221

Assignment with WAGO COMPACT-Inline Splicing Connectors with lever, type 221

Designation	L mm	B mm	H mm	221-2411
Size 2/4	32,7	56,9	17,8	2
Size 3/4	41,7	56,9	17,8	3
Size 5/4	60,7	56,9	17,8	5



Type		L mm	B mm	H mm	Housing size	Type WAGO COMPACT-Inline Splicing Connector with lever	Nominal cross section mm ²	Number of gelboxes	Art.-No.
EASY-PROTECT Inline	2/4	32,7	56,9	17,8	2	2 x 221 - 2411	0,2 - 4 0,2 - 2,5*	1	449749
	3/4	41,7	56,9	17,8	3	3 x 221 - 2411		1	449750
	5/4**	60,7	56,9	17,8	5	5 x 221 - 2411		1	449751
EASY-PROTECT Inline Bulk	2/4	32,7	56,9	17,8	2	24 x 221 - 2411	0,2 - 4 0,2 - 2,5*	12	457772
	3/4	41,7	56,9	17,8	3	36 x 221 - 2411		12	457773
	5/4**	60,7	56,9	17,8	5	60 x 221 - 2411		12	457774

* with stranded conductors

** Announced by the end of 2024

→ Continued on the next page

WAGO is a registered trademark of WAGO Verwaltungsgesellschaft mbH



→ Continuation

EASY-PROTECT INLINE Gel box

Technical data	Value	Test standard
Physical properties		
IP protection class	IPX8	EN 60529
Storage period	Indefinite storage capacity	-
Housing colour	Black	-
Housing material	Polypropylene	-
Closure type	Latching	-
Wiring direction	One-sided	-
Gel colour	Translucent amber	-
Gel material	Polyurethan	-
Thermodynamic properties		
Continuous service temperature	105 °C	EN 60998-2
Ambient temperature (operation)	85°C according to T85 marking	EN 60998-2
Working temperature / Storage temperature	0 - 40 °C	
Flammability class housing	V2*	UL 94
Electrical properties**		
Voltage range	450 V	EN 60998-2
Rated surge voltage	4 kV	EN 60998-2
Rated current	32 A respectively 41 A (WAGO COMPACT Splicing Connectors)	EN 60998-2
Resistance to electrical breakdown gel	≥ 15 kV / mm	EN 60243-1

* Approximately comparable to the glow wire test according to EN 60695

** Double insulation / observe protection class II for low voltage



EASYCELL® COMPACT Gel straight-through joint

with connection block

Universally suitable for connecting 2-core polymeric cables (e.g. NYM-J, H03VVF, H05RR-F, H07RN-F), cross section range from 0.5 mm² to 1.5 mm². Suitable for aluminium and copper conductors.

Characteristics

- Connection block completely sealed by gel - IP 68
- Re-accessible and ready for immediate operation
- New snap closing system, no cable ties required
- Connection block does not require any tool
- High-quality shockproof plastic shells, flame retardant and UV-resistant
- Quick, safe and easy assembly

Application/Suitability

- Indoor
- Outdoor
- Underground without loads
- Cable ducts

Voltage level

- 450 V, 24 A

Test standards

- VDE type-tested system according to EN IEC 60670-1

Storage conditions/Shelf life

- Unlimited shelf life



Dimensions

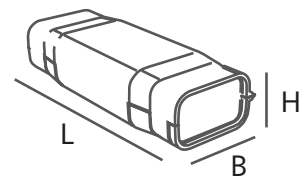

Scope of delivery

Gel straight-through joint, connection block, assembly instruction

Polymeric cable unarmoured	
	
2x	

Type	L mm	B mm	H mm	Cable-Ø mm	PU	Nominal cross section per conductor mm ²	Art.-No.
EASYCELL® COMPACT 1C-V	68	24	22	4,5 - 6,5	24	0,5 - 1,5	472575



EASYCELL® EASY...V

Gel straight-through joint

with connection block

Universally suitable for connecting all polymeric cables and conductors (e.g. N(A)YY, NYM, H05), cross section range from 1.5 mm² to 25 mm². Suitable for aluminium and copper conductors.

Characteristics

- Connector area completely sealed by gel
- Re-accessible and ready for immediate operation
- Multi range one-piece connection block
- High-quality shockproof plastic shells, flame retardant and UV-resistant
- Quick and easy assembly

Application/Suitability

- Indoor
- Outdoor
- Underground
- Water (according to test standard)

Voltage level

- U₀/U (U_m) 0.6/1 (1.2) kV

Test standards

- DIN EN 50393
- DIN EN 60695-2-11

Storage conditions/Shelf life

- Unlimited shelf life



Dimensions

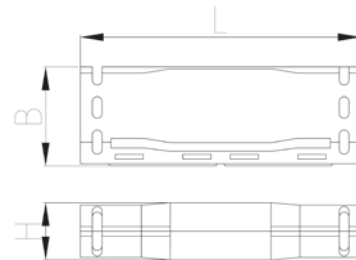

Scope of delivery

EASY 2 V: Gel straight-through joint, lustre terminal, cable ties, assembly instruction

EASY 3 V - 5 V: Gel straight-through joint, connection block, allen key, cable ties, assembly instruction

Optional accessory: EASYCELL® Strain relief, available for connecting joints from 6 mm² to 25 mm² (EASY 4 V and EASY 5 V)

		Polymeric cable unarmoured						
					3x	4x	5x	
Type		L mm	B mm	H mm	Nominal cross section per conductor mm ²			Art.-No.
EASY	2 V	86	47	27	1.5 - 2.5			389676
	3 V	146	55	35	1.5 - 6	1.5 - 6	1.5 - 6	389677
	4 V	180	69	40	6 - 16	6 - 16	6 - 16	389678
	5 V	240	75	44	16 - 25	16 - 25	16 - 25	389679



EASYCELL® EASY... Gel straight-through joint

without connection block

Universally suitable for connecting all polymeric cables and conductors (e.g. N(A)YY, NYM, H05), cross section range from 1.5 mm² to 25 mm². Suitable for aluminium and copper conductors.

Characteristics

- Connector area completely sealed by gel
- Re-accessible and ready for immediate operation
- Multiple type of connectors can be used, e. g. terminal strips, push wire connectors, mechanical blocks and c-crimp connectors
- High-quality shockproof plastic shells, flame retardant and UV-resistant
- Quick and easy assembly

Application/Suitability

- Indoor
- Outdoor
- Underground

Voltage level

- U₀/U (U_m) 0.6/1 (1.2) kV

Test standards

- DIN EN 50393

- DIN EN 60695-2-11

Storage conditions/Shelf life

- Unlimited shelf life



Dimensions

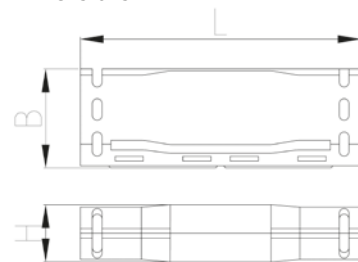



Scope of delivery

EASY 2: Gel straight-through joint, cable ties, assembly instructions

EASY 3 - 5: Gel straight-through joint, spacer, cable ties, assembly instruction

Note: For connections of up to 5-core polymeric cables we recommend to use standard EASYCELL® gel straight through joints (EASY ... V) with connection block.

Polymeric cable unarmoured	
 3x	 4x

Type		L mm	B mm	H mm	Cable-Ø mm	Nominal cross section per conductor mm ²		Art.-No.
EASY	2	86	47	27	11 - 13	1.5 - 2.5		360366
	3	146	55	35	11 - 19	1.5 - 6	1.5 - 6	360368
	4	180	69	40	15 - 23	6 - 16	6 - 16	360369
	5	240	75	44	19 - 28	16 - 25	16 - 25	360400



EASYCELL® Strain relief

for gel straight-through joints EASY 4 V and EASY 5 V

For the application with high mechanical loads and forces.

Characteristics

- Quick and easy assembly

Application/Suitability

- Mechanical protection

Scope of delivery

Strain relief



Type	Art.-No.
Strain relief	310553



EASYCELL® EASY...V Gel branch joint

with branch-off block

Universally applicable for branching all polymeric cables and conductors (e.g. N(A)YY, NYM, H05) cross section range from 6 mm² to 25 mm². Suitable for aluminium and copper conductors.

Characteristics

- Connector area completely sealed by gel
- Re-accessible and ready for immediate operation
- Multi range one-piece branch-off block
- High-quality shockproof plastic shells, flame retardant and UV-resistant
- Quick and easy assembly

Application/Suitability

- Indoor
- Outdoor
- Underground
- Water (according to test standard)

Voltage level

- U₀/U (U_m) 0.6/1 (1.2) kV

Test standards

- DIN EN 50393
- DIN EN 60695-2-11

Storage conditions/Shelf life

- Unlimited shelf life



Dimensions

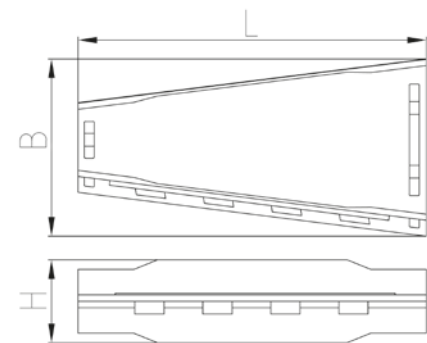

Scope of delivery

Gel branch joint, branch-off block, allen key, cable ties, assembly instruction

Note: Separable, main cable must not be cut.

Type	L mm	B mm	H mm	Polymeric cable unarmoured						Art.-No.	
				3x		4x		5x			
				Nominal cross section per conductor mm ²							
	Main cable	Branch cable	Main cable	Branch cable	Main cable	Branch cable					
EASY	6 V	220	110	53	6	2,5 - 6	6	2,5 - 6	6	2,5 - 6	371166
	7 V	260	130	65	16 - 25	2,5 - 25	16 - 25	2,5 - 25	16 - 25	2,5 - 25	371167



EXPRESS+ GEL

Two-component gel based on silicon

Only 15 seconds of mixing time for extremely fast casting

Innovative bottle with 2-component mixing compound for quick and permanent protection of electrical products. Very fast curing time with colour changing indication.

Characteristics

- Innovative mixing process
- The fastest mixing compound available on the market
- Colour change from white to light blue
- High electrical insulation value
- Non-toxic
- Easy removable
- Halogen free
- Seals and protects all electrical installations

Application/Suitability

- Indoor
- Outdoor
- Protection against moisture (IP 68 protection class in suitable housing, according to EN 60529)
- For electrical systems up to 1 kV

Storage conditions/Shelf life

- Unlimited shelf life at ambient temperatures between 5 °C and 25 °C



Scope of delivery

EXPRESS+ GEL patented mixing bottle

Type	Content ml	Art.-No.
EXPRESS+ GEL 300	300	461305
EXPRESS+ GEL 600	600	461306
EXPRESS+ GEL 900	900	461307

Technical data	Value	Test standard
Viscosity (23 °C)	288 mPa x s	ISO 2555
Pot life (23 °C)	8 min	EN 60684-2
Dielectric strength	≥ 18 kV/mm	EN 60243-1
Specific volume resistivity	1.51 x 10 ¹⁴ Ω x cm	HD 429
Mixing ratio	1 : 1	
Working temperature	5 °C up to 30 °C	
Temperature resistance	-40 °C up to 150 °C	

**POWER GEL****Two-component gel based on silicon**

to cast branch and connection boxes

Individual portioned two-component sealing compound in bottles, measuring cup and spatula, all-in-one solution for a reliable protection of electrical and electronic components.

Characteristics

- Individual portioned
- Reclosable bottles for multiple use
- Easy casting thanks to measuring cup
- Complete system
- Non-labelled and non-toxic
- Vibration damping
- Removable
- Flexible
- Halogen free
- UV rays stable
- Seals and protects all electrical installations

Application/Suitability

- Indoor (also with high humidity levels)
- Outdoor
- Branch and connection boxes
- Protection against moisture (IP 68 protection class in a suitable box)
- For electrical systems up to 1 kV

Storage conditions/Shelf life

- Unlimited shelf life at ambient temperatures between 0 °C and 40 °C

**Scope of delivery**

POWER GEL component A and component B in bottles, measuring cup and spatula

Type	Content ml	Art.-No.
POWER GEL 400	400	335120
POWER GEL 1000	1000	335121

Technical data	Value	Test standard
Viscosity (23 °C)	1000 mPa x s	ISO 2555
Pot life (23 °C)	15 min	EN 60684-2
Dielectric strength	≥ 15 kV/mm	EN 60243-1
Specific volume resistivity	≥ 2 x 10 ¹⁴ Ω x cm	HD 429
Mixing ratio	1 : 1	
Working temperature	15 °C up to 30 °C	
Temperature resistance	-40 °C up to 150 °C	



JUMBO GEL

Two-component gel based on silicon

cost-effective casting for big quantities

Transparent and economic two-component sealing compound in re-closable cans for serial casting and big branch and connection boxes.

Characteristics

- Special cost-effective and efficient
- Reclosable cans for multiple use
- Transparent
- Mix in standard bucket
- Non-labelled and non-toxic
- Vibration damping
- Removable
- Flexible
- Halogen free
- UV rays stable
- Seals and protects all electrical installations

Application/Suitability

- Indoor (also with high humidity level)
- Outdoor
- Serial casting and big boxes
- Protection against moisture (IP 68 protection class in a suitable box)
- For electrical systems up to 1 kV

Storage conditions/Shelf life

- Unlimited shelf life at ambient temperatures between 0 °C and 40 °C



Scope of delivery

JUMBO GEL component A and component B in cans

Type	Content ml	Art.-No.
JUMBO GEL	2000	364306
	5000	364307
	10000	364308
ZS-JUMBO GEL	12000	366513
Accessory kit (12000 ml bucket and spatula)		

Technical data	Value	Test standard
Viscosity (23 °C)	1000 mPa x s	ISO 2555
Pot life (23 °C)	17 min	EN 60684-2
Dielectric strength	≥ 12 kV/mm	EN 60243-1
Specific volume resistivity	≥ 2 x 10 ¹⁴ Ω x cm	HD 429
Mixing ratio	1 : 1	
Working temperature	15 °C up to 30 °C	
Temperature resistance	-25 °C up to 125 °C	

**CLEAR GEL****Two-component gel based on silicon**

to protect electrical components and LEDs

Sealing, high-transparent two-component sealing compound for a reliable protection to electrical components. Suitable for opto-electronic applications like e.g. sealing of LEDs and lighting installations

Characteristics

- Permanently high transparent
- In practical and easy-to-use two-chamber bags
- Favourable flow properties
- Application-oriented variants
- Non-labelled and non-toxic
- Vibration damping
- Removable
- Flexible
- Halogen free
- UV rays stable
- Seals and protects all electrical installations

Application/Suitability

- Indoor (also with high humidity level)
- Outdoor
- Branch and connection boxes
- Protection against moisture (IP 68 protection class in a suitable box)
- For electrical systems up to 1 kV

Storage conditions/Shelf life

- 24 months at ambient temperatures between 0 °C and 40 °C

**Scope of delivery**

CLEAR GEL component A and component B in two-chamber bags

Type		Content ml	Art.-No.
CLEAR GEL	150	150	364032
	250	250	364033
	350	350	364034
	500	500	364035

Technical data	Value	Test standard
Viscosity (23 °C)	1000 mPa x s	ISO 2555
Pot life (23 °C)	15 min	EN 60684-2
Dielectric strength	≥ 15 kV/mm	EN 60243-1
Specific volume resistivity	≥ 2 x 10 ¹⁴ Ω x cm	HD 429
Mixing ratio	1 : 1	
Working temperature	15 °C up to 30 °C	
Temperature resistance	-40 °C up to 150 °C	



SUPRA GEL

Two-component gel based on silicon

ready-to-use, delivered with static mixer for small volume boxes

Standard cartridge, filled with two-component sealing compound. User friendly casting for branch and connection boxes in one-operation without time consuming.

Characteristics

- Ready-to-use
- Mixing and casting in one step
- Clean application and precise dosing
- Reclosable cartridge for multiple use
- Favourable flow properties
- Non-labelled and non-toxic
- Removable
- Flexible
- Halogen free
- UV rays stable
- Seals and protects all electrical installations

Application/Suitability

- Indoor (also with high humidity level)
- Outdoor
- Branch and connection boxes
- Protection against moisture (IP 68 protection class in a suitable box)
- For electrical systems up to 1 kV

Storage conditions/Shelf life

- 24 months at ambient temperatures between 0 °C and 30 °C



Scope of delivery

SUPRA GEL component A and component B in a cartridge with static mixer

Type	Content ml	Art.-No.
SUPRA GEL	250	364036
Static mixer SUPRA GEL		366780

Technical data	Value	Test standard
Viscosity (23 °C)	1000 mPa x s	ISO 2555
Pot life (23 °C)	15 min	EN 60684-2
Dielectric strength	≥ 15 kV/mm	EN 60243-1
Specific volume resistivity	≥ 2 x 10 ¹⁴ Ω x cm	HD 429
Mixing ratio	1 : 1	
Working temperature	15 °C up to 30 °C	
Temperature resistance	-40 °C up to 150 °C	

**SOFT GEL****One-component gel based on silicon**

ready-to-use, suitable for a wide range of applications

Standard cartridge, filled with extremely sticky one-component sealing compound suitable for electrical insulation and protection against corrosion, also recommended for temporal solutions.

Characteristics

- Ready-to-use
- Very sticky, does not drip
- Re-accessible
- Non-labelled and non-toxic
- Reusable
- Halogen free
- UV rays stable

Application/Suitability

- Indoor
- Outdoor
- Plug-in protection
- Protection against corrosion and insects
- For electrical systems up to 1 kV

Storage conditions/Shelf life

- Unlimited shelf life at ambient temperatures between 0 °C and 40 °C
- The cartridge can be stored open

**Scope of delivery**

SOFT GEL in a cartridge with nozzle

Type	Content ml	Art.-No.
SOFT GEL	310	364723

Technical data	Value	Test standard
Viscosity (23 °C)	40000 mPa x s	
Pot life (23 °C)	-	EN 60684-2
Dielectric strength	≥ 10 kV/mm	EN 60243-1
Specific volume resistivity	≥ 2 x 10 ¹⁴ Ω x cm	HD 429
Mixing ratio	-	
Working temperature	0 °C up to 40 °C	
Temperature resistance	-40 °C up to 150 °C	

MEDIUM VOLTAGE

Cable sets for unscreened polymeric cables	131
Cable sets for screened polymeric cables	139
Cable sets for mass-impregnated paper cables	183
Heat shrinkable components	195

MEDIUM VOLTAGE

Cable sets

for unscreened polymeric cables



Straight-through joints 132



Cable terminations 136



SMH3...MS6 3-core straight-through joint

for armoured 3-core polymeric cables without semi-conductive layer up to 7.2 kV

Straight-through joints SMH3...MS6 are suitable for armoured 3-core polymeric-insulated cables (PVC, PE, XLPE, EPR) without an outer semi-conductive layer. They allow the connection of cables with different cross sections and conductor materials even with different cable design. Suitable for compression connectors.

Characteristics

- Compact dimensions
- Wide cross-section range
- Ready for immediate operation
- High mechanical strength
- Quick, safe and easy assembly

Application/Suitability

- Indoor
- Outdoor
- Underground
- Water
- Installation ducts

Voltage level

- U_0/U_m 3.6/6 (7.2) kV - 3.8/6.6 (7.2) kV

Storage conditions/Shelf life

- Unlimited shelf life



Dimensions



Scope of delivery

Thick wall heat shrinkable outer tube with hot melt adhesive, inner sheath sleeve, copper braid tube, pressure spring, cleaning tissue, emery cloth, assembly instructions

MEDIUM VOLTAGE
Cable sets for unscreened polymeric cables

Type	L mm	max. Connector-Ø mm	max. Connector length mm	Polymeric cable armoured		
				Nominal cross section mm ²	Art.-No.	
U_0/U_m 3.6/6 (7.2) kV - 3.8/6.6 (7.2) kV						
SMH3	16-50 MS6	850	16	85	16 - 50	145631
	25-70 MS6	850	20	110	25 - 70	145630
	50-150 MS6	1000	25	135	50 - 150	145633
	120-300 MS6	1200	40	150	120 - 300	145635

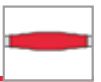

SMHSV3-1...MS6 Straight-through joint

with screw connectors, for connecting from 3-core with three 1-core polymeric cables up to 7.2 kV

Straight-through joints SMHSV3-1...MS6 are suitable for connecting 3-core polymeric cables (PVC, PE, XLPE, EPR) without outer semi-conductive layer with three 1-core polymeric cables (PVC, PE, XLPE, EPR). They allow the connection of cables with different cross sections, conductive materials and structure. With screw connectors.

Characteristics

- Compact dimensions
- Wide cross-section range
- Ready for immediate operation
- High mechanical strength
- Quick, safe and easy assembly
- Suitable for a wide range of applications due to integrated screw connector

Application/Suitability

- Indoor
- Outdoor
- Underground
- Water
- Installation ducts

Voltage level

- U_0/U_m 3.6/6 (7.2) kV - 3.8/6.6 (7.2) kV

Storage conditions/Shelf life

- Unlimited shelf life



Dimensions



Scope of delivery

Thick wall heat shrinkable outer tube with hot melt adhesive, inner sheath sleeve, copper braid tape, screw connectors, assembly material, assembly instructions

Type	L mm	Polymeric cable		Art.-No.
		unarmoured / armoured		
		Nominal cross section mm ²		
U_0/U_m 3.6/6 (7.2) kV - 3.8/6.6 (7.2) kV				
SMHSV3-1	50-150 MS6	750	50 - 150	311594
	120-240 MS6	800	120 - 240	369133

MEDIUM VOLTAGE
Cable sets for unscreened polymeric cables



M...MS6 EG 3-core straight-through joint

for armoured 3-core polymeric cables without semi-conductive layer up to 7.2 kV

Straight-through joints M...MS6 are suitable for armoured 3-core polymeric-insulated cables (PVC, PE, XLPE, EPR) without an outer semi-conductive layer. EG cast resin ensure good mechanical and moisture protection (also for automotive industry).

Characteristics

- Resistant to chemical agents
- Longitudinally and transversely watertight
- High mechanical strength
- Quick, safe and easy assembly

Application/Suitability

- Indoor
- Outdoor
- Underground
- Water
- Installation ducts

Voltage level

- U_0/U_m 3.6/6 (7.2) kV - 3.8/6.6 (7.2) kV

Storage conditions/Shelf life

- EG Cast resin up to 40 months



Dimensions

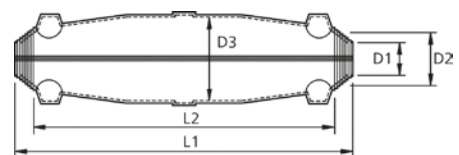

Scope of delivery

Transparent plastic shells, PUR type EG cast resin, spacer sleeve, copper braid tube, hose clamp, fill and air-release funnels, PVC insulation tape, protective gloves, assembly instructions

Note: Compression connectors should be ordered separately

Type	L1 mm	L2 mm	D1 mm	D2 mm	D3 mm	Cable-Ø mm	Polymeric insulated cable		Art.-No.	
							armoured	armoured with concentric conductor		
							Nominal cross section mm ²			
U_0/U_m 3,6/6 (7,2) kV - 3,8/6,6 (7,2) kV										
M4	MS6 EG	432	384	29	52	90	29 - 55	25 - 70	25/25 - 50/50	124318
M5	MS6 EG	550	503	40	62	110	42 - 65	95 - 120	70/70 - 95/95	124319
M6	MS6 EG	660	600	50	78	145	50 - 78	150 - 240	120/120 - 185/185	124320



M...MS6 UG 3-core straight-through joint

for armoured 3-core polymeric cables without semi-conductive layer up to 7.2 kV

Straight-through joints M...MS6 are suitable for armoured 3-core polymeric-insulated cables (PVC, PE, XLPE, EPR) without an outer semi-conductive layer. UG cast resin ensure flame protection (e.g. for mining).



Characteristics

- Resistant to chemical agents
- Longitudinally and transversely watertight
- High mechanical strength
- Quick, safe and easy assembly

Application/Suitability

- Indoor
- Outdoor
- Underground
- Water
- Installation ducts

Voltage level

- U_0/U_m 3.6/6 (7.2) kV - 3.8/6.6 (7.2) kV

Storage conditions/Shelf life

- UG Cast resin up to 24 months

Dimensions

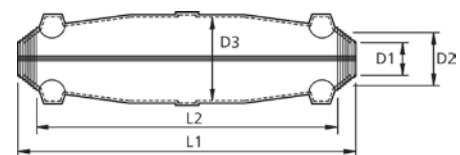

Scope of delivery

Transparent plastic shells, PUR type UG cast resin, spacer sleeve, copper braid tube, hose clamp, fill and air-release funnels, PVC insulation tape, protective gloves, assembly instructions

Note: Compression connectors should be ordered separately

Type	L1 mm	L2 mm	D1 mm	D2 mm	D3 mm	Cable-Ø mm	Polymeric insulated cable		Art.-No.	
							armoured	armoured with concentric conductor		
							Nominal cross section mm ²			
U_0/U_m 3,6/6 (7,2) kV - 3,8/6,6 (7,2) kV										
M4	MS6 UG	432	384	29	52	90	29 - 55	25 - 70	25/25 - 50/50	124359
M5	MS6 UG	550	503	40	62	110	42 - 65	95 - 120	70/70 - 95/95	124360
M6	MS6 UG	660	600	50	78	145	50 - 78	150 - 240	120/120 - 185/185	124361



SEEV

3-core indoor cable termination

for armoured 3-core polymeric cables without semi-conductive layer up to 7.2 kV

Cable terminations SEEV for indoor applications are suitable to cover armoured 3-core polymeric cables (PVC, PE, XLPE, EPR) without semi-conductive layer. Suitable for compression cable lugs.

Characteristics

- Compact dimensions
- Wide conductor and cross-section range
- High mechanical strength
- Quick, safe and easy assembly

Application/Suitability

- Indoor

Voltage level

- U_0/U_m 3.6/6 (7.2) kV - 3.8/6.6 (7.2) kV

Storage conditions/Shelf life

- Unlimited shelf life



Scope of delivery

Core insulating tubes (tracking resistant), spreader cap, filling tape, earthing accessories, sealing tape, assembly instructions

Optional accessory: Cable lugs (see Connecting technology)

Dimensions

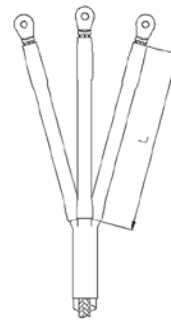

MEDIUM VOLTAGE
Cable sets for unscreened polymeric cables

Type	L mm	Polymeric cable		
		armoured		
		Nominal cross section mm ²	Art.-No.	
U_0/U_m 3.6/6 (7.2) kV - 3.8/6.6 (7.2) kV				
SEEV	16-50	280	16 - 50	145458
	70-120	280	70 - 120	145461
	150-240	280	150 - 240	145464



SEEV-F 3-core outdoor cable termination

for armoured 3-core polymeric cables without semi-conductive layer up to 7.2 kV

Cable terminations SEEV-F for outdoor applications are suitable to cover armoured 3-core polymeric cables (PVC, PE, XLPE, EPR) without semi-conductive layer. Suitable for compression cable lugs.

Characteristics

- Compact dimensions
- Wide conductor and cross-section range
- High mechanical strength
- Quick, safe and easy assembly

Application/Suitability

- Outdoor

Voltage level

- U_0/U_m 3.6/6 (7.2) kV - 3.8/6.6 (7.2) kV

Storage conditions/Shelf life

- Unlimited shelf life



Scope of delivery

Core insulating tubes (tracking resistant), spreader cap (tracking resistant), filling tape, silicone sheds, earthing accessories, sealing tape, assembly instructions

Optional accessory: Cable lugs (see Connecting technology)

Dimensions

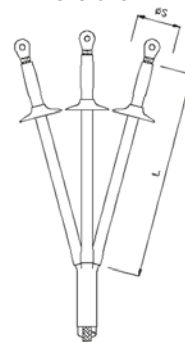

Ø S = Diameter of cable shed

MEDIUM VOLTAGE
Cable sets for unarmoured polymeric cables





Type	L mm	Ø S mm	Polymeric cable armoured		
			Nominal cross section mm ²	Art.-No.	
U_0/U_m 3.6/6 (7.2) kV - 3.8/6.6 (7.2) kV					
SEEV-F	16-50	400	80	16 - 50	148152
	70-120	400	85	70 - 120	182390
	150-240	400	85	150 - 240	148153



MEDIUM VOLTAGE

Cable sets

for screened polymeric cables

	Straight-through joints for 1-core cables.	140
	Cable terminations for 1-core cables.	150
	Separable connectors for 1-core cables.	160
	Straight-through joints for 3-core cables.	174
	Cable terminations for 3-core cables	177



CHMSV

1-core straight-through joint

with screw connector, for all 1-core polymeric cables

Hybrid straight-through joints CHMSV are suitable for all 1-core polymeric-insulated cables (PVC, PE, XLPE, EPR). They allow the connection of cables with different cross sections and conductor materials even with different cable designs concerning the semi-conductive layer (graphite-coated, removable or strippable) and screen design (copper wire or tape screen). With screw connector.

Characteristics

- Reliable stress control due to flexible silicone stress control elements
- For both copper and aluminium conductors
- For all cables with copper wire or tape screen
- Wide conductor and cross-section range
- Quick, safe and easy assembly
- Ready for immediate operation
- Suitable for a wide range of applications due to integrated screw connector

Application/Suitability

- Indoor
- Outdoor
- Underground
- Water
- Installation ducts
- Ductwork

Voltage level

- U_0/U_m 6/10 (12) kV - 19/33 (36) kV

Note

- 12 kV joints must be used for 7.2 kV cables. (Check minimum diameter over conductor insulation.)

Test standards

- CENELEC HD 629.1 (DIN VDE 0278, part 629-1)

Storage conditions/Shelf life

- Unlimited shelf life



Dimensions



MEDIUM VOLTAGE
Cable sets for screened polymeric cables

Scope of delivery

Thick wall heat shrinkable insulation tubes, thick wall heat shrinkable outer tube with hot melt adhesive, silicone stress control elements, copper braid tube, pressure springs, innovative screw connector with conductive cover, field control filling tape (blue), assembly material, assembly instructions

Note: Other straight-through joints available on request.

Type	L mm	min. Ø over core insulation after removal of the outer conductive layer mm	12 kV	17.5 kV	24 kV	36 kV	Art.-No.
			Nominal cross section mm ²				
U_0/U_m 6/10 (12) kV - 6.35/11 (12) kV							
CHMSV 12kV	25-95	600	12.6	25 - 95			258130
	70-150	600	14.7	70 - 150			258131
	95-240	600	17.3	95 - 240			258132
	240-400	650	23.1	240 - 400			258133
U_0/U_m 8.7/15 (17.5) kV							
CHMSV 17kV	25-95	600	14.7		25 - 95		258135
	70-150	600	18.0		70 - 150		258136
	95-240	600	19.9		95 - 240		258137
	240-400	700	24.0		240 - 400		258138
U_0/U_m 12/20 (24) kV - 12.7/22 (24) kV							
CHMSV 24kV	16-95	600	14.7			16 - 95	258140
	50-150	600	17.3			50 - 150	258141
	95-240	600	19.9			95 - 240	258142
	240-400	700	27.3			240 - 400	258143
U_0/U_m 18/30 (36) kV - 19/33 (36) kV							
CHMSV 36kV	50-150	600	20.9				50 - 150 258144
	95-240	600	24.2				95 - 240 258145
	240-400	700	32.0				240 - 400 258146



CHRMSV

1-core repair straight-through joint

with screw connector, for polymeric cables

Hybrid-repair-straight-through joints CHRMSV are suitable for all 1-core polymeric-insulated cables (PVC, PE, XLPE, EPR). They enable the repair of damaged cables without the use of separate cable sections. With screw connector.

Characteristics

- Reliable stress control due to flexible silicone stress control elements
- For both copper and aluminium conductors
- For all cables with copper wire or tape screen
- Wide conductor and cross-section range
- Quick, safe and easy assembly
- Ready for immediate operation
- Suitable for a wide range of applications due to integrated screw connector

Application/Suitability

- Indoor
- Outdoor
- Underground
- Water
- Installation ducts

Voltage level

- U_0/U_m 12/20 (24) kV - 12.7/22 (24) kV

Note

- 12 kV joints must be used for 7.2 kV cables. (Check minimum diameter over conductor insulation.)

Test standards

- CENELEC HD 629.1 (DIN VDE 0278, part 629-1)

Storage conditions/Shelf life

- Unlimited shelf life



Dimensions



Scope of delivery

Thick wall heat shrinkable insulation tubes, thick wall heat shrinkable outer tube with hot melt adhesive, silicone stress control elements, copper braid tube, pressure springs, innovative repair screw connector with conductive cover, field control filling tape (blue), assembly material, assembly instructions

MEDIUM VOLTAGE
Cable sets for screened polymeric cables

Type	L mm	Connector length mm	min. Ø over core insulation after removal of the outer conductive layer mm	12 kV	17,5 kV	24 kV	Art.-No.
				Nominal cross section mm ²			
U_0/U_m 12/20 (24) kV - 12.7/22 (24) kV							
CHRMSV 24kV	95-240	1000	440	150 - 240	120 - 240	95 - 240	304741



CHM...V

1-core straight-through joint

with screw connector, for all 1-core polymeric cables

Hybrid straight-through joints CHM...V are suitable for all 1-core polymeric-insulated cables (PVC, PE, XLPE, EPR). They allow the connection of cables with different cross sections and conductor materials even with different cable designs concerning the semi-conductive layer (graphite-coated, removable or strippable) and screen design (copper wire or tape screen). With screw connector.

Characteristics

- Reliable stress control due to flexible silicone stress control elements
- For both copper and aluminium conductors
- For all cables with copper wire or tape screen
- Wide conductor and cross-section range
- Quick, safe and easy assembly
- Ready for immediate operation
- Suitable for a wide range of applications due to screw connector

Application/Suitability

- Indoor
- Outdoor
- Underground
- Water
- Installation ducts
- Ductwork

Voltage level

- U_0/U_m 12/20 (24) kV - 19/33 (36) kV

Note

- 12 kV joints must be used for 7.2 kV cables. (Check minimum diameter over conductor insulation.)

Test standards

- CENELEC HD 629.1 (DIN VDE 0278, part 629-1)

Storage conditions/Shelf life

- Unlimited shelf life



Dimensions



MEDIUM VOLTAGE
Cable sets for screened polymeric cables

Scope of delivery

Thick wall heat shrinkable insulation tubes, thick wall heat shrinkable outer tube with hot melt adhesive, silicone stress control elements, copper braid tube, pressure springs, screw connector, field control filling tape (blue), assembly material, assembly instructions

Type	L mm	min. Ø over core insulation after removal of the outer conductive layer mm	12 kV	17.5 kV	24 kV	36 kV	Art.-No.
			Nominal cross section mm ²				
U_0/U_m 6/10 (12) kV - 6,35/11 (12) kV							
CHM 12kV	400-630 V	750	27,3	400 - 630			387124
U_0/U_m 12/20 (24) kV - 12.7/22 (24) kV							
CHM 24kV	400-630 V	750	32.7	630	500 - 630	400 - 630	347954
	630-1000 V	750	36.8	800 - 1000	630 - 1000	630 - 1000	308543
	800 V	1000	36.8	800	800	800	331184
U_0/U_m 18/30 (36) kV - 19/33 (36) kV							
CHM 36kV	400-630 V	750	38.5			400 - 630	347081
	630-1000 V	750	38.5			630 - 1000	347118
	800 V	750	38.5	800	800	800	347083



CHM...V

1-core straight-through joint

with screw connector, for all 1-core polymeric cables

Hybrid straight-through joints CHM...V are suitable for all 1-core polymeric-insulated cables (PVC, PE, XLPE, EPR). They allow the connection of cables with different cross sections and conductor materials even with different cable designs concerning the semi-conductive layer (graphite-coated, removable or strippable) and screen design (copper wire or tape screen). With screw connector.

Characteristics

- Reliable stress control due to flexible silicone stress control elements
- For both copper and aluminium conductors
- For all cables with copper wire or tape screen
- Wide conductor and cross-section range
- Quick, safe and easy assembly
- Ready for immediate operation
- Suitable for a wide range of applications due to screw connector

Application/Suitability

- Indoor
- Outdoor
- Underground
- Water
- Installation ducts
- Ductwork

Voltage level

- U_0/U_m 20,8/36 (42) kV

Test standards

- CENELEC HD 629.1 S3

Storage conditions/Shelf life

- Unlimited shelf life



Dimensions



Scope of delivery

Thick wall heat shrinkable insulation tubes, thick wall heat shrinkable outer tube with hot melt adhesive, silicone stress control elements, copper braid tube, pressure springs, screw connector, field control filling tape, assembly material, assembly instructions

Type	L mm	min. - max. Ø over core insulation after removal of the outer conductive layer mm	42 kV		
			Nominal cross section mm ²	Art.-No.	
U_0/U_m 20,8/36 (42) kV					
CHM 42kV	50-150 V	700	25,5 - 33,0	50-150	421451
	95-240 V	700	28,5 - 36,9	95-240	414884
	185-400 V	700	33,0 - 42,1	185-400	421453
	400-630 V	850	40,5 - 48,7	400-630	421454



CHM

1-core straight-through joint

for all 1-core polymeric cables

Hybrid straight-through joints CHM are suitable for all 1-core polymeric-insulated cables (PVC, PE, XLPE, EPR). They allow the connection of cables with different cross sections and conductor materials even with different cable designs concerning the semi-conductive layer (graphite-coated, removable or strippable) and screen design (copper wire or tape screen). Suitable for compression connectors.

Characteristics

- Reliable stress control due to flexible silicone stress control elements
- For both copper and aluminium conductors
- For all cables with copper wire or tape screen
- Wide conductor and cross-section range
- Quick, safe and easy assembly
- Ready for immediate operation

Application/Suitability

- Indoor
- Outdoor
- Underground
- Water
- Installation ducts
- Ductwork

Voltage level

- U_0/U_m 6/10 (12) kV - 19/33 (36) kV

Note

- 12 kV joints must be used for 7.2 kV cables. (Check minimum diameter over conductor insulation.)

Test standards

- CENELEC HD 629.1 (DIN VDE 0278, part 629-1)

Storage conditions/Shelf life

- Unlimited shelf life



Dimensions



MEDIUM VOLTAGE
Cable sets for screened polymeric cables

Scope of delivery

Thick wall heat shrinkable insulation tubes, thick wall heat shrinkable outer tube with hot melt adhesive, silicone stress control elements, copper braid tube, pressure springs, field control filling tape (blue), assembly material, assembly instructions

Optional accessory: Compression connectors (see Connecting technology)

Type	L mm	min. Ø over core insulation after removal of the outer conductive layer mm	max. Connector Ø mm	max. Connector length mm	12 kV	17.5 kV	Art.-No.	
					Nominal cross section mm ²			
U_0/U_m 6/10 (12) kV - 6.35/11 (12) kV								
CHM 12kV	10-25	650	9.9	16	90	10 - 25	194072	
	35-95	650	12.6	25	135	35 - 95	194073	
	95-240	650	17.3	32	145	95 - 240	194074	
	150-300	700	19.9	40	200	150 - 300	194075	
	300-400	700	23.1	40	200	300 - 400	194076	
	500-800	850	27.3	60	360	500 - 800	194077	
	800-1000	850	36.8	60	360	800 - 1000	194078	
U_0/U_m 8.7/15 (17.5) kV								
CHM 17kV	35-95	650	12.6	25	135		35 - 95	194079
	70-240	650	17.3	32	145		70 - 240	194080
	240-400	700	23.1	40	200		240 - 400	194082
	400-630	850	27.3	60	360		400 - 630	194083
	630-1000	850	36.8	60	360		630 - 1000	194085

→ Continued on the next page



→ Continuation

CHM 1-core straight-through joint

Type	L mm	min. Ø over core insulation after removal of the outer conductive layer mm	max. Connector Ø mm	max. Connector length mm	24 kV	36 kV	Art.-No.
					Nominal cross section mm ²		
U₀/U (U_m) 12/20 (24) kV - 12.7/22 (24) kV							
CHM 24kV	10-35	650	12.6	20	100	10 - 35	193339
	50-150	650	17.3	25	135	50 - 150	193370
	70-240	700	19.9	32	145	70 - 240	194086
	150-300	700	23.1	40	200	150 - 300	194087
	400-630	850	27.3	60	360	400 - 630	194088
	630-1000	850	36.8	60	360	630 - 1000	194089
U₀/U (U_m) 18/30 (36) kV - 19/33 (36) kV							
CHM 36kV	35-70	650	19.9	20	110	35 - 70	194090
	50-150	700	23.1	25	135	50 - 150	194091
	150-300	700	27.3	38	200	150 - 300	194092
	300-500	700	27.3	45	200	300 - 500	194093
	500-1000	850	36.8	60	360	500 - 1000	194094



CAM-S

1-core straight-through joint

for all 1-core polymeric cables

Contrax straight-through joints CAM-S are suitable for all 1-core polymeric-insulated cables (PVC, PE, XLPE, EPR). They allow the connection of cables with different cross sections and conductor materials even with different cable designs concerning the semi-conductive layer (graphite-coated, removable or strippable) and screen design (wire or tape screen). Suitable for compression connectors.

Characteristics

- Reliable stress control due to flexible silicone stress control elements
- Wide conductor and cross-section range
- Quick, safe and easy assembly
- Ready for immediate operation

Application/Suitability

- Indoor
- Outdoor
- Underground
- Water
- Installation ducts

Voltage level

- U_0/U_m 6/10 (24) kV - 12,7/22 (24) k

Note

- Check minimum diameter over conductor insulation

Test standards

- CENELEC HD 629.1 (DIN VDE 0278, part 629-1)

Storage conditions/Shelf life

- Unlimited shelf life



Dimensions



MEDIUM VOLTAGE
Cable sets for screened polymeric cables

Scope of delivery

Thick wall heat shrinkable outer tube with hot melt adhesive, silicone stress control elements, silicone joint body with integrated semi-conductive layer (individually tested), roll, pressure springs, semiconductor tape, assembly instructions

Optional accessory: Compression connectors (see Connecting technology)

Type	L mm	min. Ø over core insulation after removal of the outer conductive layer mm	max. Connector Ø mm	max. Connector length mm	Nominal cross section mm ²		Art.-No.	
					12 kV	24 kV		
U_0/U_m 6/10 (12) kV - 6,35/11 (12) kV								
CAM-S 12 kV	50-240	700	14,7	36	160	50-240	-	201386
U_0/U_m 12/20 (24) kV - 12,7/22 (24) kV								
CAM-S 24kV	70-240	700	19,9	36	160	-	70 - 240	201395



CAMSV-C 1-core straight-through joint

with screw connector and cold shrinkable outer protection, for all 1-core polymeric cables

Contrax-Straight-through joints CAMSV-C are suitable for all 1-core polymeric-insulated cables (PVC, PE, XLPE, EPR). They allow the connection of cables with different cross sections and conductor materials even with different cable designs concerning the semi-conductive layer (removable or strippable) and screen design (wire or tape screen). With screw connector.

Characteristics

- Slip-on silicone joint unit with integrated stress control element
- Suitable for a wide range of applications due to included screw connector
- Wide conductor and cross-section range
- For both copper and aluminium conductors
- Few components, compact design and reduced working length
- With cold shrinkable outer protection
- Quick, safe and easy assembly
- Ready for immediate operation

Application/Suitability

- Indoor
- Outdoor
- Underground
- Water
- Installation ducts

Voltage level

- U_0/U_m 6/10 (12) kV - 12.7/22 (24) kV

Note

- Joints can be used also for 7.2 kV cables. (Check minimum diameter over conductor insulation.)

Test standards

- CENELEC HD 629.1 (DIN VDE 0278, part 629-1)

Storage conditions/Shelf life

- 36 months at storage temperature between 0 °C and 40 °C



Dimensions



Scope of delivery

Cold shrinkable outer tube, silicone joint body with integrated inner and outer semi-conductive layer (individually tested), screw connector, roll, pressure springs, sealing tape, assembly instructions

MEDIUM VOLTAGE
Cable sets for screened polymeric cables

Type	L mm	min. Ø over core insulation after removal of the outer conductive layer mm	12 kV	17.5 kV	24 kV	Art.-No.	
			Nominal cross section mm ²				
U_0/U_m 6/10 (12) kV - 12.7/22 (24) kV							
	35-95	530	16,5	70 - 150	50 - 120	35 - 95	370725
CAMSV-C 24kV	95-300	600	22	150 - 300	120 - 300	95 - 300	354998
	400-630	600	29,15	400 - 630	400 - 630	400 - 630	370726



CAMSV-S

1-core straight-through joint

with screw connector and heat shrinkable outer protection, for all 1-core polymeric cables

Contrax-Straight-through joints CAMSV-S are suitable for all 1-core polymeric-insulated cables (PVC, PE, XLPE, EPR). They allow the connection of cables with different cross sections and conductor materials even with different cable designs concerning the semi-conductive layer (removable or strippable) and screen design (wire or tape screen). With screw connector.

Characteristics

- Slip-on silicone joint unit with integrated stress control element
- Suitable for a wide range of applications due to included screw connector
- Wide conductor and cross-section range
- For both copper and aluminium conductors
- Few components, compact design and reduced working length
- With heat shrinkable outer protection
- Quick, safe and easy assembly
- Ready for immediate operation

Application/Suitability

- Indoor
- Outdoor
- Underground
- Water
- Installation ducts

Voltage level

- U_0/U_m 6/10 (12) kV - 12.7/22 (24) kV

Note

- Joints can be used also for 7.2 kV cables. (Check minimum diameter over conductor insulation.)

Test standards

- CENELEC HD 629.1 (DIN VDE 0278, part 629-1)

Storage conditions/Shelf life

- Unlimited shelf life



Dimensions

MEDIUM VOLTAGE
Cable sets for screened polymeric cables

Scope of delivery

Thick wall heat shrinkable outer tube with hot melt adhesive, silicone joint body with integrated inner and outer semi-conductive layer (individually tested), screw connector, roll, pressure springs, assembly instructions

Type	L mm	min. Ø over core insulation after removal of the outer conductive layer mm	12 kV	17.5 kV	24 kV	Art.-No.	
			Nominal cross section mm ²				
U_0/U_m 6/10 (12) kV - 12.7/22 (24) kV							
CAMSV-S 24kV	35-95	600	16,5	70 - 150	50 - 120	35 - 95	370729
	95-300	650	22	150 - 300	120 - 300	95 - 300	354999
	400-630	700	29,15	400 - 630	400 - 630	400 - 630	370730



CCMSV

1-core straight-through joint

All-in-one coldshrink joint with screw connector

BBC Cellpack cold shrink Straight-through joints CCMSV are suitable for all 1-core polymeric insulated cables (with XLPE or (H)EPR insulation and with PVC, PE outer sheath). They allow the connection of cables with copper wire and tape screen with different cross sections and conductor materials even with different cable designs concerning the semi-conductive layer (removable, or strippable). With screw connector.

Characteristics

- Few components, compact design and reduced working length
- Silicon insulation body with integrated electric stress control
- Suitable for a wide range of applications due to included screw connector
- For both copper and aluminium conductors
- With cold shrinkable outer protection
- Quick, safe, and easy assembly
- Ready for immediate operation

Application/Suitability

- Indoor
- Outdoor
- Underground
- Installation ducts

Voltage Level

- U_0/U_m 6/10 (12) kV - 18/30 (36) kV

Test standards

- CENELEC HD 629.1 S3

Storage conditions/Shelf life

- 24 Monate at +5°C to +40°C



Dimensions



Scope of delivery

All-in-one cold shrinkable joint body, screw connector, silicone grease, sealing mastics, sealing MAT, pressure springs, Cu-Tape, field control filling tape, assembly material, assembly instructions

Type	L mm	min. Ø over core insulation after removal of the outer conductive layer mm	Nominal cross section mm ²				Art.-No.	
			6/10 (12) kV - 6.35/11 (12) kV	8.7/15(17.5) kV	12/20 (24) kV - 12.7/22 (24) kV	18/30 (36) kV		
U_0/U_m 6/10 (12) kV - 12.7/22 (24) kV								
CCMSV 24 kV	35-95	650	17 - 24	95	70-95	35 - 95	456087	
	95-240	700	19 - 32	150 - 240	95-240	95 - 240	456088	
	120-300	750	24 - 36	240 - 300	185-300	120 - 300	456089	
	240 RM-400	800	30 - 38	400	300-400	240 RM - 400	456150	
	300-630	800	30 - 42	400 - 630	400-630	300 - 630	456151	
U_0/U_m 12/20 (24) kV - 18/30 (36) kV								
CCMSV 36 kV	25-95	700	21.4 - 32			95	25 - 95	456153
	35-150	700	22.3 - 32			95 - 150	35 - 150	456154
	95-240	750	26 - 36			185 - 240	95 - 240	443213
	240-400	800	30.5 - 42			300 - 400	240 - 400	456155
	300-630	850	35 - 54			400 - 630	300 - 630	456156



CHESK-I

1-core indoor cable termination

with screw cable lugs, for all 1-core polymeric cables

Hybrid cable terminations CHESK-I are suitable for all 1-core polymeric-insulated cables (PVC, PE, XLPE, EPR) with different types of semi-conductive layers (graphite-coated, removable or strippable) and screen design (copper wire or tape). With screw cable lugs for main conductor and copper wire screen.

Characteristics

- Flexible silicone stress control elements ensure reliable stress control under all operating conditions
- Combination of slip-on and heat shrinkable components
- Wide cross-section range
- Quick, safe and easy assembly
- Ready for immediate operation

Application/Suitability

- Indoor

Voltage level

- U_0/U_m 6/10 (12) kV - 19/33 (36) kV

Note

- 12 kV cable terminations must be used for 7.2 kV cables. (Check minimum diameter over conductor insulation.)

Test standards

- CENELEC HD 629.1 (DIN VDE 0278, part 629-1)

Storage conditions/Shelf life

- Unlimited shelf life



Dimensions

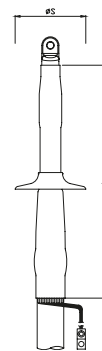

Ø S = Diameter of cable shed

Scope of delivery

1 set for 3 phases, heat shrinkable tube (tracking resistant), silicone stress control elements, silicone sheds, sealing tape, screw cable lugs, assembly material, assembly instructions

Optional accessory: EGA earthing kit for cables with tape screen (see Connecting technology)

→ Continued on the next page



→ Continuation

Type	L mm	min. Ø over core insulation after removal of the outer conductive layer mm	Number of sheds per phase	Ø S mm	12 kV	17.5 kV	24 kV	36 kV	42 kV	Art.-No.
					Nominal cross section mm ²					
U₀/U (U_m) 6/10 (12) kV - 6.35/11 (12) kV										
CHESK-I 12kV	25-95	300	12.6		25 - 95					290443
	70-150	300	17.3		70 - 150					309514
	95-240	300	17.3		95 - 240					290444
	240-400	300	19.9		240 - 400					309516
	400-630	310	27.3		400 - 630					369496
	630-1000	310	36.8		630 - 1000					369497
U₀/U (U_m) 8.7/15 (17.5) kV										
CHESK-I 17kV	35-95	300	17.3	1	85		35 - 95			309517
	50-150	300	17.3	1	85		50 - 150			309519
	95-240	300	19.9	1	85		95 - 240			309520
	240-400	300	23.1	1	85		240 - 400			309521
	400-630	310	27.3	1	115		400 - 630			369505
	630-1000	310	36.8	1	123		630 - 1000			369506
U₀/U (U_m) 12/20 (24) kV - 12.7/22 (24) kV										
CHESK-I 24kV	25-95	300	17.3	1	85		25 - 95			309522
	50-150	300	17.3	1	85		50 - 150			309523
	95-240	300	19.9	1	85		95 - 240			309525
	240-400	300	27.3	1	115		240 - 400			309526
	400-630	310	27.3	1	115		400 - 630			364848
	630-1000	310	36.8	1	123		630 - 1000			369498
U₀/U (U_m) 18/30 (36) kV - 19/33 (36) kV										
CHESK-I 36kV	16-95	500	19.9	2	85			16 - 95		309527
	50-150	500	23.1	2	85			50 - 150		309528
	95-240	500	23.1	2	85			95 - 240		309529
	240-400	500	27.3	2	115			240 - 400		309530
	400-630	500	36.8	2	115			400 - 630		369499
	630-1000	500	36.8	2	123			630 - 1000		369500
U₀/U (U_m) 20,8/36(42) kV										
CHESK-I 42kV	50-150	700	25.3	4	85				50-150	309531
	95-240	700	27.5	4	115				95-240	289708
	240-400	700	32.5	4	115				240-400	309533
	400-630	700	40.3	4	115				400-630	369501
	630-1000	700	40.3	4	123				630-1000	369502



CHE-I 1-core indoor cable termination

for all 1-core polymeric cables

Hybrid cable terminations CHE-I are suitable for all 1-core polymeric-insulated cables (PVC, PE, XLPE, EPR) with different types of semi-conductive layers (graphite-coated, removable or strippable) and screen design (copper wire or tape). Suitable for compression cable lugs.

Characteristics

- Flexible silicone stress control elements ensure reliable stress control under all operating conditions
- Combination of slip-on and heat shrinkable components
- Wide cross-section range
- Quick, safe and easy assembly
- Ready for immediate operation

Application/Suitability

- Indoor
- Voltage level**
- U_0/U_m 6/10 (12) kV - 19/33 (36) kV

Note

- 12 kV cable terminations must be used for 7.2 kV cables. (Check minimum diameter over conductor insulation.)

Test standards

- CENELEC HD 629.1 (DIN VDE 0278, part 629-1)

Storage conditions/Shelf life

- Unlimited shelf life



Dimensions

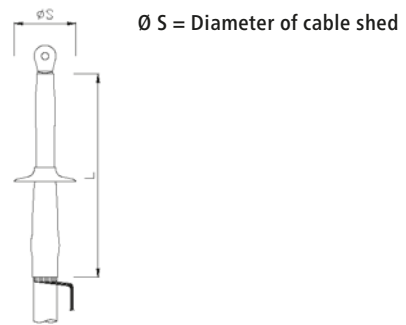

Scope of delivery

1 set for 3 phases, heat shrinkable tube (tracking resistant), silicone stress control elements, silicone sheds, sealing tape, assembly material, assembly instructions

Optional accessory: Cable lugs (see Connecting technology)
EGA earthing kit for cables with tape screen (see Connecting technology)

MEDIUM VOLTAGE
Cable sets for screened polymeric cables

Type	L mm	min. Ø over core insulation after removal of the outer conductive layer mm	Number of sheds per phase	Ø S mm	12 kV	17.5 kV	24 kV	36 kV	42 kV	Art.-No.
					Nominal cross section mm ²					
U_0/U_m 6/10 (12) kV - 6.35/11 (12) kV										
CHE-I 12kV	10-25	300	9.9		10 - 25					193414
	25-95	300	12.6		25 - 95					193416
	95-240	300	17.3		95 - 240					194017
	150-400	300	19.9		150 - 400					194018
	240-500	300	23.1		240 - 500					194019
	400-800	300	27.3		400 - 800					194030
	800-1000	300	36.8		800 - 1000					194031
U_0/U_m 8.7/15 (17.5) kV										
CHE-I 17kV	10-16	300	9.9	1	80	10 - 16				194032
	16-50	300	12.6	1	80	16 - 50				194033
	70-240	300	17.3	1	85	70 - 240				194034
	120-300	300	19.9	1	85	120 - 300				194035
	185-400	300	23.1	1	85	185 - 400				194036
	300-630	300	27.3	1	115	300 - 630				194037
	630-1000	300	36.8	1	123	630 - 1000				194038
U_0/U_m 12/20 (24) kV - 12.7/22 (24) kV										
CHE-I 24kV	10-35	300	12.6	1	85		10 - 35			194039
	25-150	300	17.3	1	85		25 - 150			194040
	70-240	300	19.9	1	85		70 - 240			194041
	120-300	300	23.1	1	85		120 - 300			194042
	240-500	300	27.3	1	115		240 - 500			194043
	630-1000	300	36.8	1	123		630 - 1000			194044
U_0/U_m 18/30 (36) kV - 19/33 (36) kV										
CHE-I 36kV	35-70	500	19.9	2	85			35 - 70		194045
	50-150	500	23.1	2	85			50 - 150		194046
	150-400	500	27.3	2	115			150 - 400		194047
	500-800	500	36.8	2	123			500 - 800		194048
U_0/U_m 20.8/36 (42) kV										
CHE-I 42kV	50-150	700	24.2	4	85				50-150	196508
	120-400	700	28.6	4	115				120-400	196509



CHESK-F

1-core outdoor cable termination

with screw cable lugs, for all 1-core polymeric cables

Hybrid cable terminations CHESK-F are suitable for all 1-core polymeric-insulated cables (PVC, PE, XLPE, EPR) with different types of semi-conductive layers (graphite-coated, removable or strippable) and screen design (copper wire or tape). With screw cable lugs for main conductor and copper wire screen.

Characteristics

- Flexible silicone stress control elements ensure reliable stress control under all operating conditions
- Combination of slip-on and heat shrinkable components
- Wide cross-section range
- Quick, safe and easy assembly
- Ready for immediate operation

Application/Suitability

- Outdoor

Voltage level

- U_0/U_m 6/10 (12) kV - 19/33 (36) kV

Note

- 12 kV cable terminations must be used for 7.2 kV cables. (Check minimum diameter over conductor insulation.)

Test standards

- CENELEC HD 629.1 (DIN VDE 0278, part 629-1)

Storage conditions/Shelf life

- Unlimited shelf life



Dimensions

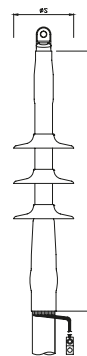

Ø S = Diameter of cable shed

Scope of delivery

1 set for 3 phases, heat shrinkable tube (tracking resistant), silicone stress control elements, silicone sheds, sealing tape, screw cable lugs, assembly material, assembly instructions

Optional accessory: EGA earthing kit for cables with tape screen (see Connecting technology)

→ Continued on the next page



→ Continuation

Type	L mm	min. Ø over core insulation after removal of the outer conductive layer mm	Number of sheds per phase	Ø S mm	12 kV	17.5 kV	24 kV	36 kV	42 kV	Art.-No.
					Nominal cross section mm ²					
U₀/U (U_m) 6/10 (12) kV - 6.35/11 (12) kV										
CHESK-F 12kV	25-95	300	12.6	1	80	25 - 95				309534
	70-150	300	17.3	1	85	70 - 150				309535
	95-240	300	17.3	1	85	95 - 240				309536
	240-400	300	19.9	1	85	240 - 400				309537
	400-630	310	27.3	1	115	400 - 630				369503
	630-1000	310	36.8	1	123	630 - 1000				369504
U₀/U (U_m) 8.7/15 (17.5) kV										
CHESK-F 17kV	35-95	500	17.3	2	85		35 - 95			309539
	50-150	500	17.3	2	85		50 - 150			309540
	95-240	500	19.9	2	85		95 - 240			309541
	240-400	500	23.1	2	85		240 - 400			309542
	400-630	500	27.3	2	115		400 - 630			369508
	630-1000	500	36.8	2	123		630 - 1000			369509
U₀/U (U_m) 12/20 (24) kV - 12.7/22 (24) kV										
CHESK-F 24kV	25-95	500	17.3	3	85			25 - 95		309545
	50-150	500	17.3	3	85			50 - 150		309546
	95-240	500	19.9	3	85			95 - 240		309548
	240-400	500	27.3	3	115			240 - 400		309550
	400-630	500	27.3	3	115			400 - 630		364847
	630-1000	500	36.8	3	123			630 - 1000		369507
U₀/U (U_m) 18/30 (36) kV - 19/33 (36) kV										
CHESK-F 36kV	16-95	700	19.9	4	85				16 - 95	309551
	50-150	700	23.1	4	85				50 - 150	309552
	95-240	700	23.1	4	85				95 - 240	309553
	240-400	700	27.3	4	115				240 - 400	309554
	400-630	700	36.8	4	115				400 - 630	369520
	630-1000	700	36.8	4	123				630 - 1000	369521
U₀/U (U_m) 20,8/36(42) kV										
CHESK-F 42kV	50-150	820	25.3	6	85				50-150	309555
	95-240	820	27.5	6	115				95-240	362230
	240-400	820	32.5	6	115				240-400	309556
	400-630	820	40.3	6	115				400-630	369522
	630-1000	820	40.3	6	123				630-1000	369523

MEDIUM VOLTAGE
Cable sets for screened polymeric cables



CHE-F

1-core outdoor cable termination

for all 1-core polymeric cables

Hybrid cable terminations CHE-F are suitable for all 1-core polymeric-insulated cables (PVC, PE, XLPE, EPR) with different types of semi-conductive layers (graphite-coated, removable or strippable) and screen design (copper wire or tape). Suitable for compression cable lugs.

Characteristics

- Flexible silicone stress control elements ensure reliable stress control under all operating conditions
- Combination of slip-on and heat shrinkable components
- Wide cross-section range
- Quick, safe and easy assembly
- Ready for immediate operation

Application/Suitability

- Outdoor

Voltage level

- $U_0/U (U_m)$ 6/10 (12) kV - 19/33 (36) kV

Note

- 12 kV cable terminations must be used for 7.2 kV cables. (Check minimum diameter over conductor insulation.)

Test standards

- CENELEC HD 629.1 (DIN VDE 0278, part 629-1)

Storage conditions/Shelf life

- Unlimited shelf life



Dimensions

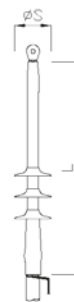

S = Diameter of cable shed

Scope of delivery

1 set for 3 phases, heat shrinkable tube (tracking resistant), silicone stress control elements, silicone sheds, sealing tape, assembly material, assembly instructions

Optional accessory: Cable lugs (see Connecting technology)

EGA earthing kit for cables with tape screen (see Connecting technology)

Type	L mm	min. Ø over core insulation after removal of the outer conductive layer mm	Number of sheds per phase	Ø S mm	12 kV	17.5 kV	24 kV	36 kV	Art.-No.	
					Nominal cross section mm ²					
$U_0/U (U_m)$ 6/10 (12) kV - 6.35/11 (12) kV										
CHE-F 12kV	10-25	300	9.9	1	80	10 - 25				194049
	25-95	300	12.6	1	80	25 - 95				194050
	95-240	300	17.3	1	85	95 - 240				194051
	150-400	300	19.9	1	85	150 - 400				194052
	240-500	300	23.1	1	85	240 - 500				194053
	400-800	300	27.3	1	115	400 - 800				194054
	800-1000	300	36.8	1	123	800 - 1000				194055
$U_0/U (U_m)$ 8.7/15 (17.5) kV										
CHE-F 17kV	10-16	500	9.9	2	80		10 - 16			194056
	16-50	500	12.6	2	80		16 - 50			194057
	70-240	500	17.3	2	85		70 - 240			194058
	120-300	500	19.9	2	85		120 - 300			194059
	185-400	500	23.1	2	85		185 - 400			194061
	300-630	500	27.3	2	115		300 - 630			194062
	630-1000	500	36.8	2	123		630 - 1000			194063
$U_0/U (U_m)$ 12/20 (24) kV - 12,7/22 (24) kV										
CHE-F 24kV	10-35	500	12.6	3	85			10 - 35		193372
	25-150	500	17.3	3	85			25 - 150		193374
	70-240	500	19.9	3	85			70 - 240		194064
	120-300	500	23.1	3	85			120 - 300		194065
	240-500	500	27.3	3	115			240 - 500		194066
	630-1000	500	36.8	3	123			630 - 1000		194067
$U_0/U (U_m)$ 18/30 (36) kV - 19/33 (36) kV										
CHE-F 36kV	35-70	700	19.9	4	85				35 - 70	194068
	50-150	700	23.1	4	85				50 - 150	194069
	150-400	700	27.3	4	115				150 - 400	194070
	500-800	700	36.8	4	123				500 - 800	194071
$U_0/U (U_m)$ 20.8/36 (42) kV										
CHE-F 42kV	50-150	820	24.2	6	85				50-150	196506
	120-400	820	28.6	6	115				120-400	196507



CAESK-I 1-core indoor cable termination

with screw cable lugs, for all 1-core polymeric cables

Contrax cable terminations CAESK-I are suitable for all 1-core polymeric-insulated cables (PVC, PE, XLPE, EPR) with different types of semi-conductive layers (graphite-coated, removable or strippable) and screen design (wire or tape). With screw cable lugs.

Characteristics

- Wide cross-section range
- Silicone slip-on components for quick, safe and easy assembly
- Ready for immediate operation

Application/Suitability

- Indoor
- ### Voltage level
- $U_0/U (U_m)$ 6/10 (12) kV - 19/33 (36) kV

Note

- 12 kV cable terminations must be used for 7.2 kV cables. (Check minimum diameter over conductor insulation.)

Test standards

- CENELEC HD 629.1 (DIN VDE 0278, part 629-1)

Storage conditions/Shelf life

- Unlimited shelf life



Dimensions



Ø S = Diameter of cable shed

Scope of delivery

3 one-piece slip-on silicone cable terminations with integrated stress control element, silicone tubes, sealing tape, screw cable lugs for main conductor, assembly material, assembly instructions

Optional accessory: EGA earthing kit for cables with tape screen (see Connecting technology)

MEDIUM VOLTAGE
Cable sets for screened polymeric cables

Type	L mm	min. Ø over core insulation after removal of the outer conductive layer mm	Number of sheds per phase	Ø S mm	12 kV	24 kV	36 kV	Art.-No.
					Nominal cross section mm ²			
$U_0/U (U_m)$ 6/10 (12) kV - 6.35/11 (12) kV								
CAESK-I 12kV	95-150	310	17.3	1	87	95 - 150		289945
	150-240	330	19.9	1	90	150 - 240		289947
	300-400	340	26.6	1	93	300 - 400		289948
	500-630	360	32.3	1	97	500 - 630		289949
$U_0/U (U_m)$ 12/20 (24) kV - 12.7/22 (24) kV								
CAESK-I 24kV	35-95	310	17.3	1	87		35 - 95	289955
	70-150	310	19.9	1	90		70 - 150	289956
	120-240	330	23.1	1	90		120 - 240	289957
	240-400	340	27.3	1	97		240 - 400	289958
	400-500	360	32.3	1	97		400 - 500	289959
$U_0/U (U_m)$ 18/30 (36) kV - 19/33 (36) kV								
CAESK-I 36kV	16-95	360	20.9	4	93		16 - 95	289960
	70-150	360	24.2	4	93		70 - 150	289961
	120-240	380	28.6	4	97		120 - 240	289962
	240-300	390	32.3	4	97		240 - 300	289963



CAE-I

1-core indoor cable termination

for all 1-core polymeric cables

Contrax cable terminations CAE-I are suitable for all 1-core polymeric-insulated cables (PVC, PE, XLPE, EPR) with different types of semi-conductive layers (graphite-coated, removable or strippable) and screen design (wire or tape). Suitable for compression cable lugs.

Characteristics

- Wide cross-section range
- Silicone slip-on components for quick, safe and easy assembly
- Ready for immediate operation

Application/Suitability

- Indoor

Voltage level

- U_0/U_m 6/10 (12) kV - 19/33 (36) kV

Note

- 12 kV cable terminations must be used for 7.2 kV cables. (Check minimum diameter over conductor insulation.)

Test standards

- CENELEC HD 629.1 (DIN VDE 0278, part 629-1)

Storage conditions/Shelf life

- Unlimited shelf life



Dimensions

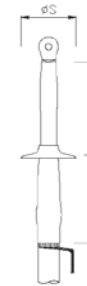

Ø S = Diameter of cable shed

Scope of delivery

3 one-piece slip-on silicone cable terminations with integrated stress control element, sealing tape, assembly material, assembly instructions

Optional accessory: Compression cable lugs (see Connecting technology)
EGA earthing kit for cables with tape screen (see Connecting technology)

Type	L mm	min. Ø over core insulation after removal of the outer conductive layer mm	Number of sheds per phase	Ø S mm	12 kV	24 kV	36 kV	Art.-No.
					Nominal cross section mm ²			
U_0/U_m 6/10 (12) kV - 6.35/11 (12) kV								
CAE-I 12kV	95-240	270	17.3	1	87	95 - 240		199151
	150-400	270	19.9	1	90	150 - 400		199152
	240-500	270	23.1	1	93	240 - 500		199154
	300-800	270	27.3	1	97	300 - 800		199155
U_0/U_m 12/20 (24) kV - 12.7/22 (24) kV								
CAE-I 24kV	35-120	270	17.3	1	87		35 - 120	199162
	70-240	270	19.9	1	90		70 - 240	199163
	120-400	270	23.1	1	93		120 - 400	199164
	240-630	270	27.3	1	97		240 - 630	199165
U_0/U_m 18/30 (36) kV - 19/33 (36) kV								
CAE-I 36kV	16-95	325	19.9	4	90		16 - 95	199166
	50-240	325	23.1	4	93		50 - 240	199167
	120-400	325	27.3	4	97		120 - 400	199168



CAESK-F

1-core outdoor cable termination

with screw cable lugs, for all 1-core polymeric cables

Contrax cable terminations CAESK-F are suitable for all 1-core polymeric-insulated cables (PVC, PE, XLPE, EPR) with different types of semi-conductive layers (graphite-coated, removable or strippable) and screen design (wire or tape). With screw cable lugs.

Characteristics

- Wide cross-section range
- Silicone slip-on components for quick, safe and easy assembly
- Ready for immediate operation

Application/Suitability

- Outdoor

Voltage level

- $U_0/U (U_m)$ 6/10 (12) kV - 19/33 (36) kV

Note

- 12 kV cable terminations must be used for 7.2 kV cables. (Check minimum diameter over conductor insulation.)

Test standards

- CENELEC HD 629.1 (DIN VDE 0278, part 629-1)

Storage conditions/Shelf life

- Unlimited shelf life



Dimensions



Ø S = Diameter of cable shed

Scope of delivery

3 one-piece slip-on silicone cable terminations with integrated stress control element, silicone tubes, sealing tape, screw cable lugs for main conductor, assembly material, assembly instructions

Optional accessory: EGA earthing kit for cables with tape screen (see Connecting technology)

MEDIUM VOLTAGE
Cable sets for screened polymeric cables

Type	L mm	min. Ø over core insulation after removal of the outer conductive layer mm	Number of sheds per phase	Ø S mm	12 kV	24 kV	36 kV	Art.-No.
					Nominal cross section mm ²			
$U_0/U (U_m)$ 6/10 (12) kV - 6.35/11 (12) kV								
CAESK-F 12kV	95-150	360	17.3	4	87	95 - 150		289894
	150-240	390	19.9	4	90	150 - 240		289897
	300-400	390	26.6	4	93	300 - 400		289898
	500-630	410	32.3	4	97	500 - 630		289899
$U_0/U (U_m)$ 12/20 (24) kV - 12.7/22 (24) kV								
CAESK-F 24kV	35-95	360	17.3	4	87		35 - 95	289905
	70-150	360	19.9	4	90		70 - 150	289906
	120-240	390	23.1	4	93		120 - 240	289907
	240-400	410	27.3	4	97		240 - 400	289908
	400-500	410	32.3	4	97		400 - 500	289909
$U_0/U (U_m)$ 18/30 (36) kV - 19/33 (36) kV								
CAESK-F 36kV	70-150	470	24.2	5	93		70 - 150	289910
	120-240	500	28.6	5	97		120 - 240	289911
	240-300	500	32.3	5	97		240 - 300	289912



CAE-F

1-core outdoor cable termination

for all 1-core polymeric cables

Contrax cable terminations CAE-F are suitable for all 1-core polymeric-insulated cables (PVC, PE, XLPE, EPR) with different types of semi-conductive layers (graphite-coated, removable or strippable) and screen design (wire or tape). Suitable for compression cable lugs.

Characteristics

- Wide cross-section range
- Silicone slip-on components for quick, safe and easy assembly
- Ready for immediate operation

Application/Suitability

- Outdoor

Voltage level

- U_0/U_m 6/10 (12) kV - 19/33 (36) kV

Note

- 12 kV cable terminations must be used for 7.2 kV cables. (Check minimum diameter over conductor insulation.)

Test standards

- CENELEC HD 629.1 (DIN VDE 0278, part 629-1)

Storage conditions/Shelf life

- Unlimited shelf life



Dimensions



Ø S = Diameter of cable shed

Scope of delivery

3 one-piece slip-on silicone cable terminations with integrated stress control element, sealing tape, assembly material, assembly instructions

Optional accessory: Compression cable lugs (see Connecting technology)
EGA earthing kit for cables with tape screen (see Connecting technology)

Type	L mm	min. Ø over core insulation after removal of the outer conductive layer mm	Number of sheds per phase	Ø S mm	12 kV	24 kV	36 kV	Art.-No.
					Nominal cross section mm ²			
U_0/U_m 6/10 (12) kV - 6.35/11 (12) kV								
CAE-F 12kV	95-240	325	17.3	4	87	95 - 240		199184
	150-400	325	19.9	4	90	150 - 400		199185
	240-500	325	23.1	4	93	240 - 500		199186
	300-800	325	27.3	4	97	300 - 800		199187
U_0/U_m 12/20 (24) kV - 12.7/22 (24) kV								
CAE-F 24kV	35-120	325	17.3	4	87		35 - 120	199194
	70-240	325	19.9	4	90		70 - 240	199195
	120-400	325	23.1	4	93		120 - 400	199196
	240-630	325	27.3	4	97		240 - 630	199197
U_0/U_m 18/30 (36) kV - 19/33 (36) kV								
CAE-F 36kV	50-240	440	23.1	5	93		50 - 240	199198
	120-400	440	27.3	5	97		120 - 400	199199



CWS 250A Elbow separable connector

for all 1-core polymeric cables, for outer cone system terminals type A

Cellplux elbow separable connectors CWS are suitable for connecting all polymeric-insulated 1-core cables (PVC, PE, XLPE, EPR), with different types of semi-conductive layers (graphite-coated or strippable) and screen design (wire or tape screen), to switching equipment and transformers having an outer cone system type A, up to maximum network voltage of 24 kV in accordance with EN 50180 and EN 50181.

Characteristics

- With capacitive measuring point
- Individually tested
- Outer semi-conductive layer made of semi-conductive EPDM provides protection from exposed electrical parts
- Cable sheath insulation fault test may be performed while under voltage
- For copper and aluminium conductors
- Quick, safe and easy assembly
- Suitable for a wide range of applications due to integrated screw cable lug

Application/Suitability

- Indoor

Voltage level

- U_0/U_m 6/10 (12) kV - 12.7/22 (24) kV

Test standards

- CENELEC HD 629.1 (DIN VDE 0278, part 629-1)

Storage conditions/Shelf life

- Unlimited shelf life



Dimensions

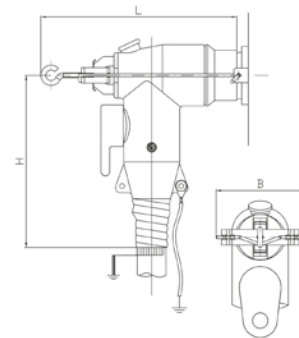

Scope of delivery

Set of 3 separable connectors, silicone stress control elements, earthing set, screw cable lug for main conductor, assembly material, assembly instructions

Optional accessory: EGA earthing kit for cables with tape screen (see Connecting technology)

Note: Elbow separable connections for alternative cross-sections and for class 5 conductors on request

Type	L mm	B mm	H mm	min. Ø over core insulation after removal of the outer conductive layer mm	12 kV	17.5 kV	24 kV	Art.-No.	
					Nominal cross section mm ²				
U_0/U_m 6/10 (12) kV - 12.7/22 (24) kV									
CWS 250A 24kV	16-95 M EGA	200	80	178	14.7	50 - 95	25 - 95	16 - 95	295167
	70-150 M EGA	200	80	178	19.9	120 - 150	95 - 150	70 - 150	293792



CGS 250A

Straight separable connector

for all 1-core polymeric cables, for outer cone system terminals type A

Cellplex straight separable connectors CGS are suitable for connecting all polymeric-insulated 1-core cables (PVC, PE, XLPE, EPR), with different types of semi-conductive layers (graphite-coated or strippable) and screen design (wire or tape screen) for switching equipment and transformers having an outer cone system type A, up to maximum network voltage of 24 kV in accordance with EN 50180 and EN 50181.

Characteristics

- With capacitive measuring point
- Individually tested
- Outer semi-conductive layer made of semi-conductive EPDM provides protection from exposed electrical parts
- Cable sheath insulation fault test may be performed while under voltage
- For copper and aluminium conductors
- Quick, safe and easy assembly
- Suitable for a wide range of applications due to integrated screw cable lug

Application/Suitability

- Indoor

Voltage level

- U_0/U_m 6/10 (12) kV - 12.7/22 (24) kV

Test standards

- CENELEC HD 629.1 (DIN VDE 0278, part 629-1)

Storage conditions/Shelf life

- Unlimited shelf life



Dimensions

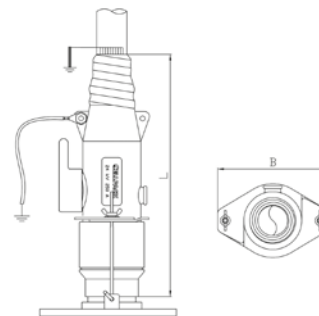

Scope of delivery

Set of 3 separable connectors, silicone stress control elements, earthing set, screw cable lug for main conductor, assembly material, assembly instructions

Optional accessory: EGA earthing kit for cables with tape screen (see Connecting technology)

Note: Straight separable connections for alternative cross-sections and for class 5 conductors on request

Type	L mm	B mm	min. Ø over core insulation after removal of the outer conductive layer mm	12 kV	17.5 kV	24 kV	Art.-No.	
				Nominal cross section mm ²				
U_0/U_m 6/10 (12) kV - 12.7/22 (24) kV								
CGS 250A 24kV	25-95 M EGA	248	110	14.7	50 - 95	25 - 95	25 - 95	295283
	70-150 M EGA	248	110	19.9	120 - 150	95 - 150	70 - 150	293797



CWS 400A Elbow separable connector

for all 1-core polymeric cables, for outer cone system terminals type B

Cellplex elbow separable connectors CWS are suitable for connecting all polymeric-insulated 1-core cables (PVC, PE, XLPE, EPR), with different types of semi-conductive layers (graphite-coated or strippable) and screen design (wire or tape screen), to switching equipment and transformers having an outer cone system type B, up to maximum network voltage of 36 kV in accordance with EN 50180 and EN 50181.

Characteristics

- With capacitive measuring point
- Individually tested
- Outer semi-conductive layer made of semi-conductive EPDM provides protection from exposed electrical parts
- Cable sheath insulation fault test may be performed while under voltage
- For copper and aluminium conductors
- Quick, safe and easy assembly
- Suitable for a wide range of applications due to integrated screw cable lug

Application/Suitability

- Indoor
- Voltage level**
- U_0/U_m (U_m) 6/10 (12) kV - 19/33 (36) kV
- Test standards**
- CENELEC HD 629.1 (DIN VDE 0278, part 629-1)
- Storage conditions/Shelf life**
- Unlimited shelf life



Dimensions

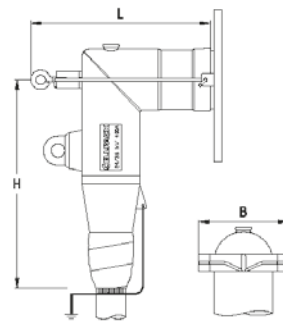

Scope of delivery

Set of 3 separable connectors, silicone stress control elements, earthing set, screw cable lug for main conductor, assembly material, assembly instructions

Optional accessory: EGA earthing kit for cables with tape screen (see Connecting technology)

Note: Elbow separable connections for alternative cross-sections and for class 5 conductors on request

Type	L mm	B mm	H mm	min. Ø over core insulation after removal of the outer conductive layer mm	12 kV	17.5 kV	24 kV	36 kV	Art.-No.	
					Nominal cross section mm ²					
U_0/U_m 6/10 (12) kV - 12.7/22 (24) kV										
CWS 400A 24kV	25-70 EGA	215	107	250	14.7	50 - 95	25 - 95	25 - 70	250720	
	95-240 EGA	215	107	250	22.0	150 - 240	120 - 240	95 - 240	246176	
U_0/U_m 12/20 (24) kV - 19/33 (36) kV										
CWS 400A 36kV	35-95 EGA	215	107	250	22,0			95 - 95	35 - 95	250726
	95-150 EGA	215	107	250	22,0			95-240	95-150	359558
	150-240 EGA	215	107	250	30,8			240 - 240	150 - 240	247102



CTS 630A

T-shaped separable connector

for all 1-core polymeric cables, for outer cone system terminals type C

Cellpack screwable T-shaped separable connectors CTS are suitable for connecting all polymeric-insulated 1-core cables (PVC, PE, XLPE, EPR), with different types of semi-conductive layers (graphite-coated or strippable) and screen design (wire or tape screen) to switching equipment and transformers having an outer cone system type C, up to maximum network voltage of 36 kV in accordance with EN 50180 and EN 50181

Characteristics

- With capacitive measuring point
- Individually tested
- Outer semi-conductive layer made of semi-conductive EPDM provides protection from exposed electrical parts
- Cable sheath insulation fault test may be performed while under voltage
- For copper and aluminium conductors
- Quick, safe and easy assembly
- Suitable for a wide range of applications due to integrated screw cable lug

Application/Suitability

- Indoor
- Outdoor

Voltage level

- U_0/U_m 6/10 (12) kV - 19/33 (36) kV

Test standards

- CENELEC HD 629.1 (DIN VDE 0278, part 629-1)

Storage conditions/Shelf life

- Unlimited shelf life



Dimensions

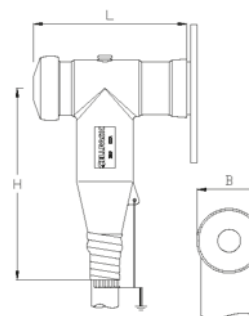

Scope of delivery

Set of 3 separable connectors, silicone stress control elements, earthing set, screw cable lug for main conductor, assembly material, assembly instructions

Optional accessory: EGA earthing kit for cables with tape screen (see Connecting technology)

Note: Other T-shaped separable connectors (cross-sections, class 5) available on request

Type	L mm	B mm	H mm	min. Ø over core insulation after removal of the outer conductive layer mm	12 kV	17.5 kV	24 kV	36 kV	Art.-No.	
					Nominal cross section mm ²					
U_0/U_m 6/10 (12) kV - 12.7/22 (24) kV										
CTS 630A 24kV	25-70	194	85	250	14.7	50 - 95	25 - 95	25 - 70	355434	
	95-240	194	85	250	22.0	150 - 240	120 - 240	95 - 240	355433	
	240-400	194	85	250	23.7	240 - 400	240 - 400	240 - 400	355561	
U_0/U_m 12/20 (24) kV - 19/33 (36) kV										
CTS 630A 36kV	35-95	194	85	250	22.0			95 - 95	35 - 95	355562
	95-120	194	85	250	22.0			95 - 240	95 - 120	355563
	150-240	194	85	250	30.8			240 - 240	150 - 240	355564
	240-400	194	85	265	31.5			300 - 400	240 - 400	356660



CTS 1250A T-shaped separable connector

for all 1-core polymeric cables, for outer cone system terminals type C

Cellplex screwable T-shaped separable connectors CTS are suitable for connecting all polymeric-insulated 1-core cables (PVC, PE, XLPE, EPR), with different types of semi-conductive layers (graphite-coated or strippable) and screen design (wire or tape screen) to switching equipment and transformers having an outer cone system type C, up to maximum network voltage of 36 kV in accordance with EN 50180 and EN 50181.

Characteristics

- With capacitive measuring point
- Individually tested
- Outer semi-conductive layer made of semi-conductive EPDM provides protection from exposed electrical parts
- Cable sheath insulation fault test may be performed while under voltage
- For copper and aluminium conductors
- Quick, safe and easy assembly
- Suitable for a wide range of applications due to integrated screw cable lug

Application/Suitability

- Indoor
- Voltage level**
- U_0/U_m 6/10 (12) kV - 19/33 (36) kV

Test standards

- CENELEC HD 629.1 (DIN VDE 0278, part 629-1)

Storage conditions/Shelf life

- Unlimited shelf life



Dimensions

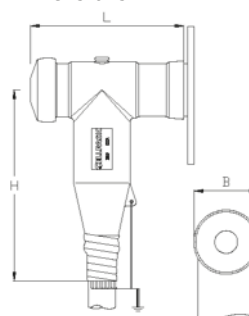

Scope of delivery

Set of 3 separable connectors, silicone stress control elements, earthing set, screw cable lug for main conductor, screw cable lug for wire screen, assembly material, assembly instructions

Optional accessory: EGA earthing kit for cables with tape screen (see Connecting technology)

Note: Other T-shaped separable connectors (cross-sections, class 5) available on request

Type	L mm	B mm	H mm	min. Ø over core insulation after removal of the outer conductive layer mm	12 kV	17.5 kV	24 kV	36 kV	Art.-No.	
					Nominal cross section mm ²					
U_0/U_m 6/10 (12) kV - 12.7/22 (24) kV										
CTS 1250A 24kV	400-630	EGA M12 KS	205	87	310	33.4	500 - 630	400 - 630	400 - 630	309283
U_0/U_m 12/20 (24) kV - 19/33 (36) kV										
CTS 1250A 36kV	400-630	EGA M12 KS	205	87	310	39.1		630	400 - 630	309284



CTKS 630A

T-shaped separable coupling connector

for all 1-core polymeric cables, for separable connector type CTS

Cellpack T-shaped separable coupling connectors CTKS are suitable for connecting all polymeric-insulated 1-core cables (PVC, PE, XLPE, EPR), with different types of semi-conductive layers (graphite-coated or strippable) and screen design (wire or tape screen) to the back of T-shaped separable connectors type CTS.

Characteristics

- With capacitive measuring point
- Individually tested
- Outer semi-conductive layer made of semi-conductive EPDM provides protection from exposed electrical parts
- Cable sheath insulation fault test may be performed while under voltage
- For copper and aluminium conductors
- Quick, safe and easy assembly
- Suitable for a wide range of applications due to integrated screw cable lug

Application/Suitability

- Indoor
- Voltage level**
- $U_0/U (U_m)$ 6/10 (12) kV - 19/33 (36) kV
- Test standards**
- CENELEC HD 629.1 (DIN VDE 0278, part 629-1)
- Storage conditions/Shelf life**
- Unlimited shelf life



Dimensions

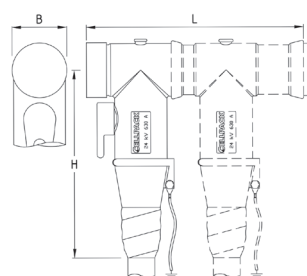

Scope of delivery

Set of 3 separable coupling connectors, silicone stress control elements, earthing set, screw cable lug for main conductor, assembly material, assembly instructions

Optional accessory: EGA earthing kit for cables with tape screen (see Connecting technology)

Note: T-shaped separable coupling connector for alternative cross-sections and for class 5 conductors on request

Type	L mm	B mm	H mm	min. Ø over core insulation after removal of the outer conductive layer mm	12 kV	17.5 kV	24 kV	36 kV	Art.-No.	
					Nominal cross section mm ²					
$U_0/U (U_m)$ 6/10 (12) kV - 12.7/22 (24) kV										
CTKS 630A 24kV	25-70 EGA	290	74	250	14.7	50 - 95	25 - 95	25 - 70		256838
	95-240 EGA	290	74	250	22.0	150 - 240	120 - 240	95 - 240		256839
$U_0/U (U_m)$ 12/20 (24) kV - 19/33 (36) kV										
CTKS 630A 36kV	35-95	310	85	250	22.0			95 - 95	35 - 95	257581
	95-120	310	85	250	22.0			95-240	95-120	479476
	150-240	310	85	250	30.8			240 - 240	150 - 240	257582
	240-400	310	85	250	31.5			300 - 400	240 - 400	353314



CTKSA Coupling surge arrester

Class DH, for separable connector type CTS

The Cellplux surge arrester CTKSA Class DH are designed to protect encapsulated medium voltage systems. The CTKSA coupling surge arresters are specifically designed for mounting on shielded, screw-type Cellpack cable connections and comply with the international standards IEC 60099-4 and IEC 60071.

Characteristics

- With capacitive measuring point
- Individually tested
- Safe-to-touch as the EPDM body is protected by outer semiconductive screen and it is connected to earth
- Quick, safe and easy assembly

Application/Suitability

- Indoor
- Outdoor

Storage conditions/Shelf life

- Unlimited shelf life



Scope of delivery

Set of 3 surge arresters, assembly material, assembly instructions

Power frequency versus time characteristic (TOV)

(maximum temperature: 60°C)

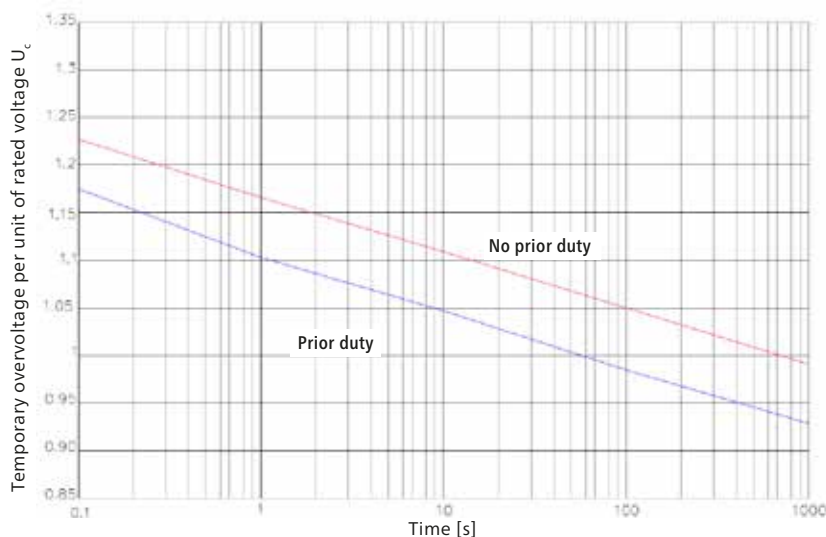

Dimensions

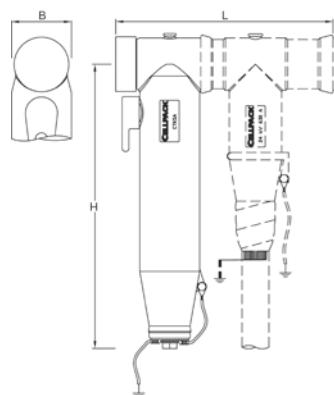

Type		L mm	B mm	H mm	Art.-No.
CTKSA	8 kV	290	80	380	423851
	12 kV	290	80	380	423852
	18 kV	290	80	380	423853
	19,5 kV	290	80	380	423854
	22 kV	290	80	380	423855
	24 kV	290	80	380	423856
	34 kV	290	80	380	423857

Technical Data							
Rated discharge current, I _n [kA]	10						
High current impulse 4/10 μs [kA]	100						
Rated short-circuit current [kA]	20						
Repetitive charge transfer rating, Q _{rs} [C]	0,5						
Thermal charge transfer rating, Q _{th} [C]	1,1						
Technical Data / Type	8 kV	12 kV	18 kV	19,5 kV	22 kV	24 kV	34 kV
Rated voltage, U _r [kV]	10,0	15,0	22,5	24,0	27,0	30,0	42,0
Maximum continuous operating voltage, U _c [kV]	8,0	12,7	18,3	19,5	22,0	24,4	34,0
Residual voltage (IEC 60099-4) [kV] with:							
Steep current impulse (1/T, T < 20 μs)	28,3	42,5	63,8	68,0	76,5	85,0	119,0
Lightning impulse 8/20 μs:							
5 kA	24,8	37,2	55,7	59,6	67,0	74,4	104,0
10 kA	26,9	40,3	60,5	64,4	72,5	80,5	112,8
20 kA	29,3	44,0	66,0	70,4	79,2	88,0	123,2



ZS Accessory kit

for separable connectors

The ZS-CTS accessory set is designed for the reinstallation of T-shaped separable connectors CTS to the switchgears and transformers with an outer cone of type C, in accordance with EN 50180 and EN 50181. The ZS-CTKSA accessory set is designed for the reinstallation of T-shaped surge arrester CTKSA. The ZS-CPS / CPES / CPAS Accessory set is suitable for installation of insulating plugs, Test Kits into the separable connectors of type CTS/CTKS. The ZS-LPVT accessory set is suitable for installation of the voltage sensors into separable connectors of type CTS/CTS-S/CTKS/CTKSA.

Characteristics

- Easy assembly

Application/Suitability

- Re-installation of the separable connectors of type CTS
- Re-installation of the separable surge arresters of type CTKSA
- Re-installation of the insulating plugs/ Installation of CPS, CPES, CPAS.
- Installation of the voltage sensors



Scope of delivery

ZS-CTS: Set of 3 contact bolts with shear heads, 6 Cleaning tissues, 3 grease and filling agent (GM1), 1 applicator AH3, working instructions

ZS-CTKSA: Set of 3 contact bolts with shear heads, 6 Cleaning tissues, 3 grease and filling agent (GM1), 1 applicator AH3, working instructions

ZS-CPS/CPES/CPAS: 9 Cleaning tissues, 6 grease and filling agent (GM1), 3 pairs protective gloves and 1 applicator AH2

ZS-LPVT: 9 Cleaning tissues, 3 grease and filling agent (GM1), 3 pairs protective gloves and 1 applicator AH3

Type	Art.-No.
CTS 630A	257622
CTS 1250A	374292
ZS CTKSA	478149
CPS/CPES/CPAS	365078
LPVT (voltage sensors) (IEC-61869-11)	391083



CIK Voltage-resistant insulating cap

for bushings type A 250A and type C 630A

The voltage-resistant insulating caps CIK are suitable for electrical insulation of bushings (outer cones) type A 250A and type C 630A on transformers and gas-insulated switchgears up to 36 kV, in accordance with EN 50180 and EN 50181.

Characteristics

- Submersible
- Outer semi-conductive layer made of semi-conductive EPDM provides protection from exposed electrical parts
- Easy assembly

Application/Suitability

- Indoor
- Outdoor

Voltage level

- $U_0/U (U_m)$ 6/10 (12) kV - 19/33 (36) kV

Storage conditions/Shelf life

- Unlimited shelf life



Scope of delivery

Set of 3 voltage resistant insulating caps, assembly material, assembly instructions

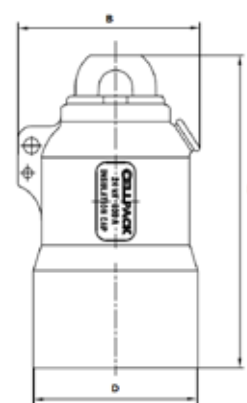

Type	B	D	H	Art.-No.
	mm			
$U_0/U (U_m)$ 6/10 (12) kV - 12,7/22 (24) kV				
CIK 250A 24kV	82	68	116	265023
CIK 630A 24kV	93	82	160	372710
$U_0/U (U_m)$ 6/10 (12) kV - 19/33 (36) kV				
CIK 630A 36kV	93	82	160	265024

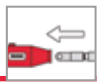

CVS 250A

Connecting element up to 24 kV

for separable connectors type CWS and type CGS, for outer cone system terminals type A

The connecting element CVS is suitable for connecting two elbow separable connectors type CWS 250A and/or straight separable connectors CGS up to 24 kV. Its dimensions correspond to outer cone systems type A, in accordance with EN 50180 and EN 50181.

Characteristics

- Individually tested
- Safe and easy to handle
- Easy assembly

Application/Suitability

- Indoor
- Voltage level**
- U_0/U_m 6/10 (12) kV - 12.7/22 (24) kV
- Storage conditions/Shelf life**
- Unlimited shelf life



Scope of delivery

Set of 3 connecting elements, assembly material, assembly instructions

Dimensions

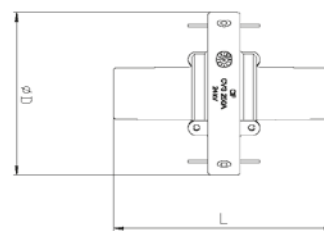

Type	L mm	Ø D mm	Art.-No.
U_0/U_m 6/10 (12) kV - 12.7/22 (24) kV			
CVS 250A 24kV	136	100	225844



CKS 1250A

Coupling element up to 36 kV

for T-shaped separable connectors type CTS

The coupling element CKS is suitable for connecting two T-shaped separable connectors CTS up to 36 kV. It can be used for 630 A and 1250 A applications.

Characteristics

- Individually tested
- Safe and easy to handle
- Easy assembly

Application/Suitability

- Indoor
- Voltage level**
- U_0/U_m 19/33 (36) kV

Test standards

- IEC 60137

Storage conditions/Shelf life

- Unlimited shelf life



Dimensions

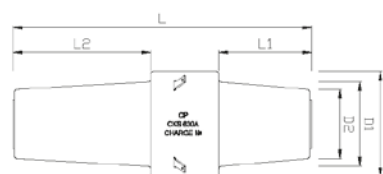

D = Outer diameter

Scope of delivery

Set of 3 coupling elements, assembly material, assembly instructions

Type	L mm	L1 mm	L2 mm	D mm	D1 mm	D2 mm	Art.-No.
U_0/U_m 19/33 (36) kV							
CKS 1250A 36kV	196.5	61.5	91	70	56	46	450152

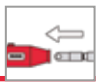

CPAS End-plugs

for Cellplex separable connector type CTS 630A / 1250A

The CPAS End-plug establishes connection on front side of the CTS 630A / 1250A separable connectors. CPAS together with Test and earthing kit CPES makes it possible to carry out testing of cables installed with CTS separable connectors without connecting them to Switchgear.

Characteristics

- Individually tested
- Safe and easy to handle
- Easy Assembly

Application/Suitability

- Indoor
- Outdoor

Voltage level

- $U_0/U (U_m)$ 6/10 (12) kV - 19/33 (36) kV

Storage conditions/ Shelf life

- Unlimited shelf life



Scope of delivery

Set of 3 End-plugs,, assembly material, assembly instructions.

Type	Art.-No.
$U_0/U (U_m)$ 6/10 (12) kV - 19/33 (36) kV	
CPAS	367094



CPES

Test and earthing kit

for Cellplux separable connectors type CTS and type CTKS

The test and grounding set is used on the one hand to connect the respective cable conductors to a test voltage source and on the other hand to establish a reliable grounding of cable conductors on all Cellplux T-connectors type CTS and CTKS.

Characteristics

- Safe and easy to handle

Application/Suitability

- Cable testing
- Cable fault location
- Earthing for work
- Phase comparison

Test standards

- For cables according CENELEC HD 620, VDE 0275 part 620

Voltage level

- $U_0/U (U_m)$ 6/10 (12) kV - 19/33 (36) kV



Scope of delivery

Chest, test adapter (Length = 345 mm, Thread = M12), set of 3 earthing adapters (\emptyset Ball = 20mm), assembly material, assembly instructions

Optional accessory: Accessory kit ZS-CPS/CPES/CPAS (Art.-No. 365078)

Type	Art.-No.
$U_0/U (U_m)$ 6/10 (12) kV - 19/33 (36) kV	
CPES	414307

Test	Test voltage	Test time
AC 45-60 Hz	max 2 U_0	max 60 minutes
VLF 0.1 Hz	max 3 U_0	max 60 minutes

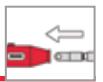

CPS Test kit

for Cellplux separable connectors type CTS and type CTKS

The test set is used to connect the respective cable conductors to a test voltage source on all Cellplux T-connectors type CTS and CTKS.

Characteristics

- Safe and easy to handle

Application/Suitability

- Cable testing
- Cable fault location
- Phase comparison

Test standards

- For cables according CENELEC HD 620, VDE 0275 part 620

Voltage level

- $U_0/U (U_m)$ 6/10 (12) kV - 19/33 (36) kV



Scope of delivery

Chest, set of 3 test adapters (Length = 345 mm, Thread = M12), assembly material, assembly instructions

Optional accessory: Accessory kit ZS-CPS/CPES/CPAS (Art.-No. 365078)

Type	Art.-No.
$U_0/U (U_m)$ 6/10 (12) kV - 19/33 (36) kV	
CPS	302227

Test	Test voltage	Test time
AC 45-60 Hz	max 2 U_0	max 60 minutes
VLF 0.1 Hz	max 3 U_0	max 60 minutes



CHMSV3 3-core straight-through joint

with screw connectors, for all 3-core polymeric cables

Hybrid straight-through joints CHMSV3 are suitable for all 3-core polymeric-insulated cables (PVC, PE, XLPE, EPR). They allow the connection of cables with copper wire screen with different cross sections and conductor materials even with different cable designs concerning the semi-conductive layer (graphite-coated, removable or strippable). With screw connectors.

Characteristics

- Reliable stress control due to flexible silicone stress control elements
- For both copper and aluminium conductors
- For all cables with copper wire screen
- Wide conductor and cross-section range
- Quick, safe and easy assembly
- Ready for immediate operation
- Suitable for a wide range of applications due to integrated screw connector

Application/Suitability

- Indoor
- Outdoor
- Underground
- Water
- Installation ducts
- Ductwork

Voltage level

- U_0/U_m 6/10 (12) kV - 19/33 (36) kV

Test standards

- CENELEC HD 629.1 (DIN VDE 0278, part 629-1)

Storage conditions/Shelf life

- Unlimited shelf life



Dimensions



MEDIUM VOLTAGE
Cable sets for screened polymeric cables

Scope of delivery

Thick wall heat shrinkable insulation tubes, thick wall heat shrinkable outer tube with hot melt adhesive, silicone stress control element, copper braid tape, field control filling tape (blue), innovative screw connectors with conductive cover, screw connector for copper-wire screen, assembly material, assembly instructions

Optional accessory: EGA earthing kit for cables with tape screen (see Connecting technology)

Note: Straight-through joints with larger cross-section available on request.

Type	L mm	min. Ø over core insulation after removal of the outer conductive layer mm	12 kV	17.5 kV	24 kV	36 kV	Art.-No.
			Nominal cross section mm ²				
U_0/U_m 6/10 (12) kV - 6.35/11 (12) kV							
CHMSV3 12kV	25-95	1050	12.6	25 - 95			297348
	70-150	1050	14.7	70 - 150			297350
	95-240	1100	17.3	95 - 240			297260
	240-400	1250	23.1	240 - 400			297358
U_0/U_m 8.7/15 (17.5) kV							
CHMSV3 17kV	25-95	1050	14.7		25 - 95		297349
	70-150	1050	18.0		70 - 150		297351
	95-240	1100	19.9		95 - 240		297310
	240-400	1250	24.0		240 - 400		297360
U_0/U_m 12/20 (24) kV - 12.7/22 (24) kV							
CHMSV3 24kV	16-95	1050	14.7		16 - 95		297433
	50-150	1050	17.3		50 - 150		297352
	95-240	1100	19.9		95 - 240		297104
	240-400	1250	27.3		240 - 400		297361
U_0/U_m 18/30 (36) kV - 19/33 (36) kV							
CHMSV3 36kV	50-150	1050	20.9			50 - 150	297353
	95-240	1100	24.2			95 - 240	297311
	240-400	1250	32.0			240 - 400	297362



CHMSV3-1 Straight-through joint

with screw connectors, for connecting from 3-core with three 1-core polymeric cables

Hybrid straight-through joints CHMSV3-1 are suitable for connecting 3-core polymeric cables with three 1-core polymeric cables (PVC, PE, XLPE, EPR). They allow the connection of cables with copper wire screen with different cross sections and conductor materials even with different cable designs concerning the semi-conductive layer (graphite-coated, removable or strippable). With screw connectors.

Characteristics

- Reliable stress control due to flexible silicone stress control elements
- For both copper and aluminium conductors
- For all cables with copper wire screen
- Wide conductor and cross-section range
- Quick, safe and easy assembly
- Ready for immediate operation
- Suitable for a wide range of applications due to integrated screw connector

Application/Suitability

- Indoor
- Outdoor
- Underground
- Water
- Installation ducts
- Ductwork

Voltage level

- U_0/U_m 6/10 (12) kV - 19/33 (36) kV

Test standards

- CENELEC HD 629.1 (DIN VDE 0278, part 629-1)

Storage conditions/Shelf life

- Unlimited shelf life



Dimensions



Scope of delivery

Thick wall heat shrinkable insulation tubes, thick wall heat shrinkable outer tube with hot melt adhesive, silicone stress control element, copper braid tape, field control filling tape (blue), innovative screw connectors with conductive cover, screw connector for copper-wire screen, assembly material, assembly instructions

Optional accessory: EGA earthing kit for cables with tape screen (see Connecting technology)

Note: Straight-through joints with larger cross-section available on request.

Type	L mm	min. Ø over core insulation after removal of the outer conductive layer mm	12 kV	17.5 kV	24 kV	36 kV	Art.-No.
			Nominal cross section mm ²				
U_0/U_m 6/10 (12) kV - 6.35/11 (12) kV							
CHMSV3-1 12kV	25-95	900	12.6	25 - 95			297449
	70-150	900	14.7	70 - 150			297462
	95-240	900	17.3	95 - 240			297442
	240-400	1000	23.1	240 - 400			297466
U_0/U_m 8.7/15 (17.5) kV							
CHMSV3-1 17kV	25-95	900	14.7	25 - 95			297460
	70-150	900	18.0	70 - 150			297463
	95-240	900	19.9	95 - 240			297443
	240-400	1000	24.0	240 - 400			297467
U_0/U_m 12/20 (24) kV - 12.7/22 (24) kV							
CHMSV3-1 24kV	16-95	900	14.7		16 - 95		297461
	50-150	900	17.3		50 - 150		297464
	95-240	900	19.9		95 - 240		297441
	240-400	1000	27.3		240 - 400		297468
U_0/U_m 18/30 (36) kV - 19/33 (36) kV							
CHMSV3-1 36kV	50-150	900	20.9			50 - 150	297465
	95-240	900	24.2			95 - 240	297444
	240-400	1000	32.0			240 - 400	297469



CHM3 3-core straight-through joint

for all 3-core polymeric cables

Hybrid straight-through joints CHM3 are suitable for all 3-core polymeric-insulated cables (PVC, PE, XLPE, EPR). They allow the connection of cables with different cross sections and conductor materials even with different cable designs concerning the semi-conductive layer (graphite-coated, removable or strippable) and screen design (copper wire or tape screen). Suitable for compression connectors.

Characteristics

- Reliable stress control due to flexible silicone stress control elements
- Wide conductor and cross-section range
- Quick, safe and easy assembly
- Ready for immediate operation

Application/Suitability

- Indoor
- Outdoor
- Underground
- Water
- Installation ducts
- Ductwork

Voltage level

- U_0/U_m 6/10 (12) kV - 19/33 (36) kV

Note

- 12 kV joints must be used for 7.2 kV cables. (Check minimum diameter over conductor insulation.)

Test standards

- CENELEC HD 629.1 (DIN VDE 0278, part 629-1)

Storage conditions/Shelf life

- Unlimited shelf life



Dimensions



MEDIUM VOLTAGE
Cable sets for screened polymeric cables

Scope of delivery

Thick wall heat shrinkable insulation tubes, thick wall heat shrinkable outer tube with hot melt adhesive, silicone stress control element, copper braid tube, pressure springs, field control filling tape (blue), assembly material, assembly instructions

Optional accessory: Compression connectors (see Connecting technology)

Note: Straight-through joints with larger cross-section available on request.

Type	L mm	min. Ø over core insulation after removal of the outer conductive layer mm	max. Connector-Ø mm	max. Connector length mm	12 kV	17.5 kV	24 kV	36 kV	Art.-No.
					Nominal cross section mm ²				
U_0/U_m 6/10 (12) kV - 6.35/11 (12) kV									
CHM3 12kV	10-25	1200	9.9	16	90	10 - 25			194293
	35-95	1200	12.6	25	135	35 - 95			194294
	95-240	1200	17.3	32	145	95 - 240			194295
	150-300	1200	19.9	40	200	150 - 300			194296
U_0/U_m 8.7/15 (17.5) kV									
CHM3 17kV	35-95	1200	12.6	25	135	35 - 95			194297
	70-240	1200	17.3	32	145	70 - 240			194298
	120-300	1200	19.9	34	150	120 - 300			194299
	240-400	1200	23.1	40	200	240 - 400			194300
U_0/U_m 12/20 (24) kV - 12.7/22 (24) kV									
CHM3 24kV	10-35	1200	12.6	20	100		10 - 35		194301
	50-150	1200	17.3	25	135		50 - 150		194302
	70-240	1200	19.9	32	145		70 - 240		194303
	150-300	1200	23.1	40	200		150 - 300		194304
U_0/U_m 18/30 (36) kV - 19/33 (36) kV									
CHM3 36kV	35-70	1200	19.9	20	110			35 - 70	194305
	50-150	1200	23.1	25	135			50 - 150	194306
	150-300	1200	27.3	38	200			150 - 300	194307



CHESK-3I(A)

3-core indoor cable termination

with screw cable lugs, for all 3-core polymeric cables

Hybrid cable terminations CHESK-3I(A) are suitable for all 3-core polymeric-insulated cables (PVC, PE, XLPE, EPR) with different types of semi-conductive layers (graphite-coated, removable or strippable) and screen design (copper wire or tape). With screw cable lugs.

Characteristics

- Flexible silicone stress control elements ensure reliable stress control under all operating conditions
- Combination of slip-on and heat shrinkable components
- Wide cross-section range
- Quick, safe and easy assembly
- Ready for immediate operation

Application/Suitability

- Indoor
- Voltage level**
- $U_0/U (U_m)$ 6/10 (12) kV - 19/33 (36) kV

Note

- 12 kV cable terminations must be used for 7.2 kV cables. (Check minimum diameter over conductor insulation.)

Test standards

- CENELEC HD 629.1 (DIN VDE 0278, part 629-1)

Storage conditions/Shelf life

- Unlimited shelf life



Dimensions

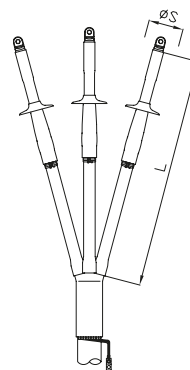

Ø S = Diameter of cable shed

Scope of delivery

Spreader cap, heat shrinkable tube (tracking resistant), heat shrinkable tube, silicone stress control elements, silicone sheds, binding wire, sealing tape, screw cable lugs, assembly material, assembly instructions

Optional accessory: EGA earthing kit for cables with tape screen (see Connecting technology)

Type	L mm	min. Ø over core insulation after removal of the outer conductive layer mm	Number of sheds per phase	Ø S mm	12 kV	17.5 kV	24 kV	36 kV	Art.-No.
					Nominal cross section mm ²				
$U_0/U (U_m)$ 6/10 (12) kV - 6.35/11 (12) kV									
CHESK-3I(A) 12kV	25-95	600	12.6		25 - 95				309800
	95-240	600	17.3		95 - 240				309801
	240-400	600	19.9		240 - 400				309802
$U_0/U (U_m)$ 12/20 (24) kV - 12.7/22 (24) kV									
CHESK-3I(A) 24kV	25-95	600	17.3	1	85	25 - 95	25 - 95		309806
	95-240	600	19.9	1	85	95 - 240	95 - 240		309807
	240-400	600	27.3	1	115	240 - 400	240 - 400		309808
$U_0/U (U_m)$ 18/30 (36) kV - 19/33 (36) kV									
CHESK-3I(A) 36kV	25-95	800	19.9	2	85			25 - 95	309810
	95-240	800	23.1	2	85			95 - 240	309811
	240-400	800	27.3	2	115			240 - 400	309812



CHE-3I(A) 3-core indoor cable termination

for all 3-core polymeric cables

Hybrid cable terminations CHE-3I(A) are suitable for all 3-core polymeric-insulated cables (PVC, PE, XLPE, EPR) with different types of semi-conductive layers (graphite-coated, removable or strippable) and screen design (copper wire or tape). Suitable for compression cable lugs.

Characteristics

- Flexible silicone stress control elements ensure reliable stress control under all operating conditions
- Combination of slip-on and heat shrinkable components
- Wide cross-section range
- Quick, safe and easy assembly
- Ready for immediate operation

Application/Suitability

- Indoor

Voltage level

- U_0/U_m 6/10 (12) kV - 19/33 (36) kV

Note

- 12 kV cable terminations must be used for 7.2 kV cables. (Check minimum diameter over conductor insulation.)

Test standards

- CENELEC HD 629.1 (DIN VDE 0278, part 629-1)

Storage conditions/Shelf life

- Unlimited shelf life



Dimensions

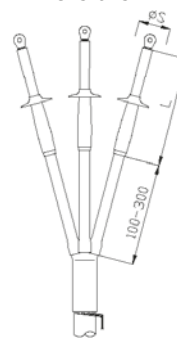

Ø S = Diameter of cable shed

Scope of delivery

Spreader cap, heat shrinkable tube (tracking resistant), heat shrinkable tube, silicone stress control elements, silicone sheds, pressure spring, sealing tape, assembly material, assembly instructions

Optional accessory: Cable lugs (see Connecting technology)

EGA earthing kit for cables with tape screen (see Connecting technology)

Note: Other cable terminations available on request.

Type	L mm	min. Ø over core insulation after removal of the outer conductive layer mm	Number of sheds per phase	Ø S mm	12 kV	17.5 kV	24 kV	36 kV	Art.-No.
					Nominal cross section mm ²				
U_0/U_m 6/10 (12) kV - 6.35/11 (12) kV									
CHE-3I(A) 12kV	10-25	300	9.9		10 - 25				146228
	25-95	300	12.6		25 - 95				146216
	95-240	300	17.3		95 - 240				146217
	150-400	300	19.9		150 - 400				146218
U_0/U_m 8.7/15 (17.5) kV									
CHE-3I(A) 17kV	16-50	300	12.6	1	85	16 - 50			195365
	70-240	300	17.3	1	85	70 - 240			171761
	150-300	300	19.9	1	85	150 - 300			171762
	185-400	300	23.1	1	85	185 - 400			171763
U_0/U_m 12/20 (24) kV - 12.7/22 (24) kV									
CHE-3I(A) 24kV	10-35	300	12.6	1	85		10 - 35		146300
	25-95	300	17.3	1	85		25 - 95		146302
	70-240	300	19.9	1	85		70 - 240		146301
	120-300	300	23.1	1	85		120 - 300		146297
U_0/U_m 18/30 (36) kV - 19/33 (36) kV									
CHE-3I(A) 36kV	35-70	500	19.9	2	85			35 - 70	146158
	50-150	500	23.1	2	85			50 - 150	146159
	150-400	500	27.3	2	115			150 - 400	146160



CHE-3I-T

3-core indoor cable termination

for 3-core polymeric flexible cables

Hybrid cable terminations CHE-3I are suitable for 3-core polymeric-insulated flexible cables of type: EpN 78, NTSCGEW0EU. Suitable for compression cable lugs.

Characteristics

- Flexible silicone stress control elements ensure reliable stress control under all operating conditions
- Combination of slip-on and heat shrinkable components
- Wide cross-section range
- Quick, safe and easy assembly
- Ready for immediate operation

Application/Suitability

- Indoor
- Voltage level**
- U_0/U_m 3,6/6 (7,2) - 12/20 (24) kV
- Test standards**
- CENELEC HD 629.1
- Storage conditions/Shelf life**
- Unlimited shelf life



Dimensions

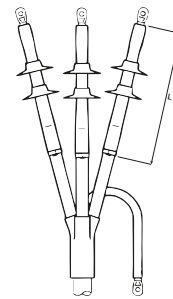

Ø S = Diameter of cable shed

Scope of delivery

Spreader cap, heat shrinkable tube (tracking resistant), heat shrinkable tube, silicone stress control elements, silicone sheds, pressure spring, sealing tape, assembly material, working instructions

Optional accessory: Cable lugs (see Connecting technology)

Note: Other customised terminations available on request

Type	L mm	min. Ø over core insulation after removal of the outer conductive layer mm	Number of sheds per phase	Ø S mm	7.2 kV	12 kV	24 kV	Art.-No.
					Nominal cross section, class 5 (IEC 60228) mm ²			
U_0/U_m 3,6/6 (7,2) kV - 3,8/6,6 (7,2) kV								
CHE-3I-T 7.2 kV	300	18.2	-	-	70-120			169459
U_0/U_m 6/10 (12) kV - 6,35/11 (12) kV								
CHE-3I-T 12 kV	300	13.2	-	-		25-50		146309
	300	18.2	-	-		70-120		146310
U_0/U_m 12/20 (24) kV - 12,7/22 (24) kV								
CHE-3I-T 24 kV	400	18.2	1	21			25-70	167690



CHESK-3F(A)

3-core outdoor cable termination

with screw cable lugs, for all 3-core polymeric cables

Hybrid cable terminations CHESK-3F(A) are suitable for all 3-core polymeric-insulated cables (PVC, PE, XLPE, EPR) with different types of semi-conductive layers (graphite-coated, removable or strippable) and screen design (copper wire or tape). With screw cable lugs.

Characteristics

- Flexible silicone stress control elements ensure reliable stress control under all operating conditions
- Combination of slip-on and heat shrinkable components
- Wide cross-section range
- Quick, safe and easy assembly
- Ready for immediate operation

Application/Suitability

- Outdoor

Voltage level

- $U_0/U (U_m)$ 6/10 (12) kV - 19/33 (36) kV

Note

- 12 kV cable terminations must be used for 7.2 kV cables. (Check minimum diameter over conductor insulation.)

Test standards

- CENELEC HD 629.1 (DIN VDE 0278, part 629-1)

Storage conditions/Shelf life

- Unlimited shelf life

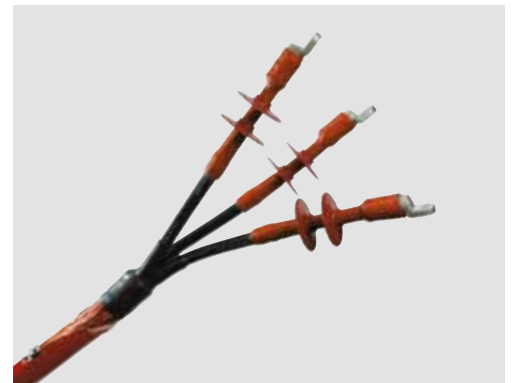

Dimensions

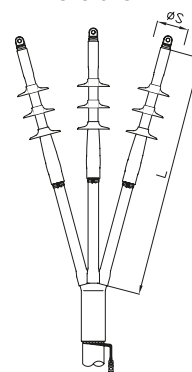

Ø S = Diameter of cable shed

Scope of delivery

Spreader cap, heat shrinkable tube (tracking resistant), heat shrinkable tube, silicone stress control elements, silicone sheds, binding wire, sealing tape, screw cable lugs, assembly material, assembly instructions

Optional accessory: EGA earthing kit for cables with tape screen (see Connecting technology)

MEDIUM VOLTAGE
Cable sets for screened polymeric cables

Type	L mm	min. Ø over core insulation after removal of the outer conductive layer mm	Number of sheds per phase	Ø S mm	Nominal cross section mm ²				Art.-No.	
					12 kV	17.5 kV	24 kV	36 kV		
$U_0/U (U_m)$ 6/10 (12) kV - 6.35/11 (12) kV										
CHESK-3F(A) 12kV	25-95	1200	12.6	1	80	25 - 95				309813
	95-240	1200	17.3	1	85	95 - 240				309815
	240-400	1200	19.9	1	85	240 - 400				309816
$U_0/U (U_m)$ 12/20 (24) kV - 12.7/22 (24) kV										
CHESK-3F(A) 24kV	25-95	1200	17.3	3	85		25 - 95	25 - 95		309820
	95-240	1200	19.9	3	85		95 - 240	95 - 240		309821
	240-400	1200	27.3	3	115		240 - 400	240 - 400		309822
$U_0/U (U_m)$ 18/30 (36) kV - 19/33 (36) kV										
CHESK-3F(A) 36kV	25-95	1200	19.9	4	85				25 - 95	309823
	95-240	1200	23.1	4	85				95 - 240	309824
	240-400	1200	27.3	4	115				240 - 400	309583



CHE-3F(A)

3-core outdoor cable termination

for all 3-core polymeric cables

Hybrid cable terminations CHE-3F(A) are suitable for all 3-core polymeric-insulated cables (PVC, PE, XLPE, EPR) with different types of semi-conductive layers (graphite-coated, removable or strippable) and screen design (copper wire or tape). Suitable for compression cable lugs.

Characteristics

- Flexible silicone stress control elements ensure reliable stress control under all operating conditions
- Combination of slip-on and heat shrinkable components
- Wide cross-section range
- Quick, safe and easy assembly
- Ready for immediate operation

Application/Suitability

- Outdoor

Voltage level

- U_0/U_m 6/10 (12) kV - 19/33 (36) kV

Note

- 12 kV cable terminations must be used for 7.2 kV cables. (Check minimum diameter over conductor insulation.)

Test standards

- CENELEC HD 629.1
(DIN VDE 0278, part 629-1)

Storage conditions/Shelf life

- Unlimited shelf life



Dimensions

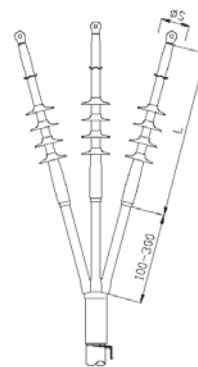

Ø S = Diameter of cable shed

Scope of delivery

Spreader cap, heat shrinkable tube (tracking resistant), heat shrinkable tube, silicone stress control elements, silicone sheds, pressure spring, sealing tape, assembly material, assembly instructions

Optional accessory: Cable lugs (see Connecting technology)
EGA earthing kit for cables with tape screen (see Connecting technology)



Note: Other cable terminations available on request.

Type	L mm	min. Ø over core insulation after removal of the outer conductive layer mm	Number of sheds per phase	Ø S mm	12 kV	17.5 kV	24 kV	36 kV	Art.-No.	
					Nominal cross section mm ²					
U_0/U_m 6/10 (12) kV - 6.35/11 (12) kV										
CHE-3F(A) 12kV	10-25	300	9.9	1	80	10 - 25			146226	
	25-95	300	12.6	1	85	25 - 95			146220	
	95-240	300	17.3	1	85	95 - 240			146222	
	150-400	300	19.9	1	85	150 - 400			146224	
U_0/U_m 8.7/15 (17.5) kV										
CHE-3F(A) 17kV	16-50	500	12.6	2	85		16 - 50		195366	
	70-240	500	17.3	2	85		70 - 240		171756	
	150-300	500	19.9	2	85		150 - 300		171757	
	185-400	500	23.1	2	85		185 - 400		146296	
U_0/U_m 12/20 (24) kV - 12.7/22 (24) kV										
CHE-3F(A) 24kV	10-35	500	12.6	3	85			10 - 35	146303	
	25-95	500	17.3	3	85			25 - 95	146304	
	70-240	500	19.9	3	85			70 - 240	146306	
	120-300	500	23.1	3	85			120 - 300	146298	
U_0/U_m 18/30 (36) kV - 19/33 (36) kV										
CHE-3F(A) 36kV	35-70	700	19.9	4	85				35 - 70	146234
	50-150	700	23.1	4	85				50 - 150	146235
	150-400	700	27.3	4	115				150 - 400	146242



MEDIUM VOLTAGE

Cable sets for mass-impregnated paper cables

	Transition joints.....	185
	Straight-through joints.....	193

Overview: BBC Cellpack Cable sets selection table

Products	Belted cables			H-Type cables			3 lead sheath cables		
	Transition joints	Straight-through joints	Cable terminations	Transition joints	Straight-through joints	Cable terminations	Transition joints	Straight-through joints	Cable terminations
CHMPRSV3-1	●	–	–	●	–	–	–	–	–
CHMPR3-1	●	–	–	●	–	–	–	–	–
CHMPR3	●	–	–	●	–	–	–	–	–
CHMP(H)SV3-1	–	–	–	●	–	–	–	–	–
CHMP(H)3-1	–	–	–	●	–	–	–	–	–
CHMP(3Pb)SV3-1	–	–	–	–	–	–	●	–	–
CHMP(3Pb)3-1	–	–	–	–	–	–	●	–	–
CHMP(3Pb)3	–	–	–	–	–	–	●	–	–
CHMPPR3	–	●	–	–	●	–	–	–	–

- suitable
- non suitable

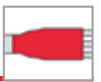

CHMPRSV3-1 Transition joint

with screw connectors, from belted cables/H-Type cables to 1-core polymeric cables

Hybrid transition joints CHMPRSV3-1 for transition to three 1-core polymeric-insulated cables, are suitable for belted cables and H-Type cables up to 17.5 kV. With screw connectors.

Characteristics

- Reliable stress control due to flexible silicone stress control elements
- Wide cross-section range
- Quick, safe and easy assembly
- Ready for immediate operation
- Suitable for a wide range of applications due to innovative integrated screw connector

Application/Suitability

- Indoor
- Outdoor
- Underground
- Water
- Installation ducts
- Ductwork

Voltage level

- U_0/U_m 6/10 (12) kV - 8.7/15 (17.5) kV

Test standards

- CENELEC HD 629.2 (DIN VDE 0278, part 629-2)

Storage conditions/Shelf life

- Unlimited shelf life



Dimensions

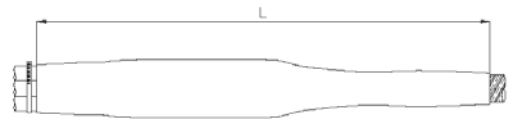

Scope of delivery

Spreader cap, thick wall heat shrinkable outer tube with hot melt adhesive, oil barrier tubing, heat shrinkable tubes, silicone stress control elements, earthing wire, copper braid tape, pressure spring, screw connector for copper-wire screen, assembly material, sealing tape, field control filling tape (blue), fire protection wrapping, innovative screw connectors with conductive cover, assembly instructions

Type	L mm	min. Ø over core insulation after removal of the outer conductive layer mm	Nominal cross section mm ²		Art.-No.	
			12 kV	17.5 kV		
U_0/U_m 6/10 (12) kV - 8.7/15 (17.5) kV						
CHMPRSV3-1 17kV	35-95	1200	12.6	50 - 95	35 - 95	264988
	70-150	1200	17.3	95 - 150	70 - 150	265205
	95-240	1200	17.3	95 - 240	95 - 240	264769
	240-400	1200	23.1	240 - 400	240 - 400	265501



CHMPR3-1 Transition joint

from belted cables/H-Type cables to three 1-core polymeric cables

Hybrid transition joints CHMPR3-1 for transition to three 1-core polymeric-insulated cables, are suitable for belted cables and H-Type cables up to 17.5 kV. The scope of application can be reduced by an appropriate padding set for the mass-impregnated paper cable. Suitable for compression connectors.

Characteristics

- Reliable stress control due to flexible silicone stress control elements
- Wide cross-section range
- Quick, safe and easy assembly
- Ready for immediate operation

Application/Suitability

- Indoor
- Outdoor
- Underground
- Water
- Installation ducts
- Ductwork

Voltage level

- U_0/U_m 6/10 (12) kV - 8.7/15 (17.5) kV

Test standards

- CENELEC HD 629.2 (DIN VDE 0278, part 629-2)

Storage conditions/Shelf life

- Unlimited shelf life



Dimensions

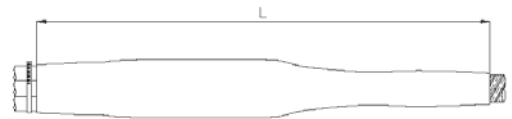

MEDIUM VOLTAGE
Cable sets for mass-impregnated paper cables

Scope of delivery

Spreader cap, thick wall heat shrinkable outer tube with hot melt adhesive, oil barrier tubing, heat shrinkable tubes, silicone stress control elements, earthing wire, copper braid tape, pressure spring, assembly material, sealing tape, field control filling tape (blue), fire protection wrapping, assembly instructions

Optional accessory: Compression connectors (see Connecting technology)

Note: Other transition joints available on request.

Type	L mm	min. Ø over core insulation after re- moval of the outer conductive layer mm	12 kV			17.5 kV			Art.-No.	
			Nominal cross section mm ²	max. Connector- Ø mm	max. Connector length mm	Nominal cross section mm ²	max. Connector- Ø mm	max. Connector length mm		
U_0/U_m 6/10 (12) kV - 8.7/15 (17.5) kV										
CHMPR3-1 17kV	35-50	1100	12.6	35-70	25	130	35 - 50	20	110	197603
	70-240	1100	17.3	95 - 240	34	145	70 - 240	34	145	197604 ¹⁾
	240-400	1100	23.1	300 - 400	42	170	240 - 400	42	170	197606

¹⁾ Padding kit PS(G+H) 17/1 (Art.-No.197690) to be used for 25 - 50 mm² (17.5 kV) and (25) 35 - 70 mm² (12 kV).

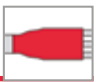

CHMPR3 Transition joint

from belted cables/H-Type cables to 3-core polymeric cables

Hybrid transition joints CHMPR3 for transition to one 3-core polymeric-insulated cable, are suitable for belted cables and H-Type cables up to 17.5 kV. The scope of application can be reduced by an appropriate padding set for the mass-impregnated paper cable. Suitable for compression connectors.

Characteristics

- Reliable stress control due to flexible silicone stress control elements
- Wide cross-section range
- Quick, safe and easy assembly
- Ready for immediate operation

Application/Suitability

- Indoor
- Outdoor
- Underground
- Water
- Installation ducts
- Ductwork

Voltage level

- U_0/U_m 6/10 (12) kV - 8.7/15 (17.5) kV

Test standards

- CENELEC HD 629.2
(DIN VDE 0278, part 629-2)

Storage conditions/Shelf life

- Unlimited shelf life

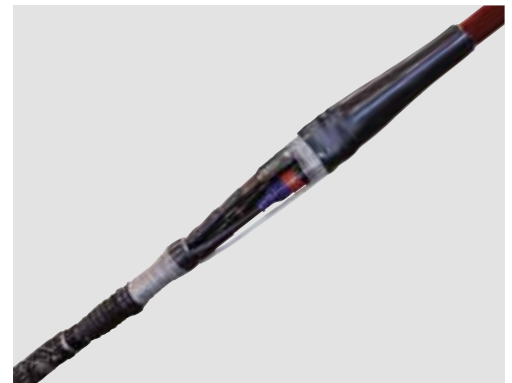

Dimensions

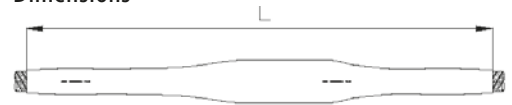

Scope of delivery

Spreader cap, thick wall heat shrinkable outer tube with hot melt adhesive, oil barrier tubing, heat shrinkable tubes, silicone stress control elements, earthing wire, copper braid tape, pressure spring, assembly material, sealing tape, field control filling tape (blue), fire protection wrapping, assembly instructions

Optional accessory: Compression connectors (see Connecting technology)

Note: Other transition joints available on request.

Type	L mm	min. Ø over core insulation after re- moval of the outer conductive layer mm	12 kV			17.5 kV			Art.-No.	
			Nominal cross section mm ²	max. Connector- Ø mm	max. Connector length mm	Nominal cross section mm ²	max. Connector- Ø mm	max. Connector length mm		
U_0/U_m 6/10 (12) kV - 8.7/15 (17.5) kV										
CHMPR3 17kV	35-50	1400	12.6	35 - 70	25	130	35 - 50	20	110	197618
	70-240	1400	17.3	95 - 240	34	145	70 - 240	34	145	197619 ¹⁾
	240-400	1400	23.1	300 - 400	42	170	240 - 400	42	170	197620

¹⁾ Padding kit PS(G+H) 17/1 (Art.-No.197690) to be used for 25 - 50 mm² (17.5 kV) and (25) 35 - 70 mm² (12 kV).



CHMP(H)SV3-1 Transition joint

with screw connectors, from H-Type cables to polymeric three 1-core cables

Hybrid transition joints CHMP(H)SV3-1 for transition to three 1-core polymeric-insulated cables, are suitable for H-Type cables for 24 kV. With screw connectors.

Characteristics

- Reliable stress control due to flexible silicone stress control elements
- Wide cross-section range
- Quick, safe and easy assembly
- Ready for immediate operation

Application/Suitability

- Indoor
- Outdoor
- Underground
- Water
- Installation ducts
- Ductwork

Voltage level

- U_0/U_m 12/20 (24) kV - 12.7/22 (24) kV

Test standards

- CENELEC HD 629.2 (DIN VDE 0278, part 629-2)

Storage conditions/Shelf life

- Unlimited shelf life

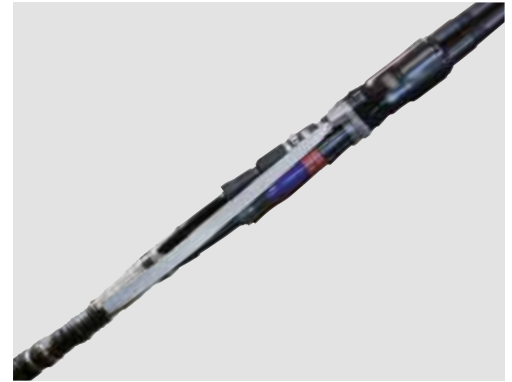

Dimensions

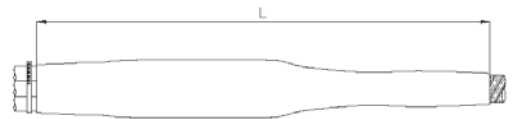

Scope of delivery

Spreader cap, thick wall heat shrinkable outer tube with hot melt adhesive, oil barrier tubing, heat shrinkable tubes, silicone stress control elements, earthing wire, copper braid tape, pressure spring, assembly material, sealing tape, field control filling tape (blue), fire protection wrapping, innovative screw connectors with conductive cover, assembly instructions

MEDIUM VOLTAGE
Cable sets for mass-impregnated paper cables

Type	L mm	min. Ø over core insulation after removal of the outer conductive layer mm	24 kV	
			Nominal cross section mm ²	Art.-No.
U_0/U_m 12/20 (24) kV - 12.7/22 (24) kV				
CHMP(H)SV3-1 24kV	35-95	1100	17.3	336538
	70-150	1100	19.9	336550
	95-240	1100	19.9	336551

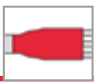

CHMP(H)3-1 Transition joint

from H-Type cables to polymeric three 1-core cables

Hybrid transition joints CHMP(H)3-1 for transition to three 1-core polymeric-insulated cables, are suitable for H-Type cables from 24 to 36 kV. The scope of application can be reduced by an appropriate padding set for the mass-impregnated paper cable. Suitable for compression connectors.

Characteristics

- Reliable stress control due to flexible silicone stress control elements
- Wide cross-section range
- Quick, safe and easy assembly
- Ready for immediate operation

Application/Suitability

- Indoor
- Outdoor
- Underground
- Water
- Installation ducts
- Ductwork

Voltage level

- U_0/U_m 12/20 (24) kV - 19/33 (36) kV

Test standards

- CENELEC HD 629.2
(DIN VDE 0278, part 629-2)

Storage conditions/Shelf life

- Unlimited shelf life

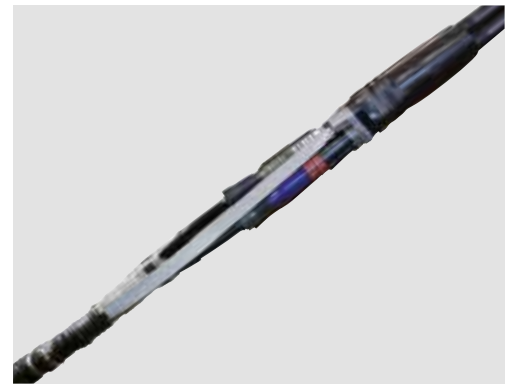

Dimensions

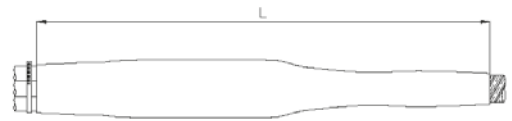

Scope of delivery

Spreader cap, thick wall heat shrinkable outer tube with hot melt adhesive, oil barrier tubing, heat shrinkable tubes, silicone stress control elements, earthing wire, copper braid tape, pressure spring, assembly material, sealing tape, field control filling tape (blue), fire protection wrapping, assembly instructions

Optional accessory: Compression connectors (see Connecting technology)

Note: Other transition joints available on request.

Type	L mm	min. Ø over core insulation after re- moval of the outer conductive layer mm	max. Connector- Ø mm	max. Connector length mm	24 kV	36 kV	Art.-No.
					Nominal cross section mm ²		
U_0/U_m 12/20 (24) kV - 12.7/22 (24) kV							
CHMP(H)3-1 24kV	35-70	1200	17.3	20	110	35 - 70	197608
	95-240	1200	19.9	34	145	95 - 240	197609 ¹⁾
	185-300	1200	23.1	42	145	185 - 300	197610
U_0/U_m 18/30 (36) kV - 19/33 (36) kV							
CHMP(H)3-1 36kV	35-50	1200	19.9	20	110	35 - 50	197614
	70-150	1200	23.1	28	145	70 - 150	197616
	150-300	1200	27.3	36	145	150 - 300	197617

¹⁾ Padding kit PS(H) 24/1 (Art.-No.197692) to be used for 35 - 70 mm² (24 kV).



CHMP(3Pb)SV3-1 Transition joint

with screw connectors, for 3 lead sheath cables to three 1-core polymeric cables

Hybrid transition joints CHMP(3Pb)SV3-1 for transition to three 1-core polymeric-insulated cables are suitable for all 3 lead sheath cables for 24 kV. With screw connectors.

Characteristics

- Reliable stress control due to flexible silicone stress control elements
- Wide cross-section range
- Quick, safe and easy assembly
- Ready for immediate operation

Application/Suitability

- Indoor
- Outdoor
- Underground
- Water
- Installation ducts
- Ductwork

Voltage level

- U_0/U_m 12/20 (24) kV - 12.7/22 (24) kV

Test standards

- CENELEC HD 629.2 (DIN VDE 0278, part 629-2)

Storage conditions/Shelf life

- Unlimited shelf life



Dimensions

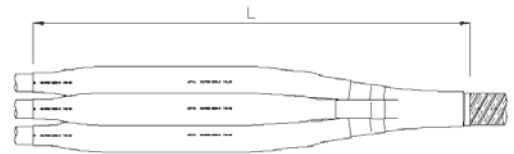

Scope of delivery

Spreader cap, thick wall heat shrinkable outer tube with hot melt adhesive, oil barrier tubing, heat shrinkable tubes, silicone stress control elements, earthing wire, copper braid tape, pressure spring, innovative screw connectors with conductive cover, assembly material, sealing tape, field control filling tape (blue), fire protection wrapping, assembly instructions

Type	L mm	min. Ø over core insulation after removal of the outer conductive layer mm	24 kV	
			Nominal cross section mm ²	Art.-No.
U_0/U_m 12/20 (24) kV - 12.7/22 (24) kV				
CHMP(3Pb)SV3-1 24kV	35-95	1000	17.3	35 - 95
	50-150	1000	17.3	50 - 150
	95-240	1000	19.9	95 - 240
	240-400	1000	27.3	240 - 400

MEDIUM VOLTAGE
Cable sets for mass-impregnated paper cables



CHMP(3Pb)3-1 Transition joint

for 3 lead sheath cables to three 1-core polymeric cables

Hybrid transition joints CHMP(3Pb)3-1 for transition to three 1-core polymeric-insulated cables are suitable for all 3 lead sheath cables up to 36 kV. The scope of application can be reduced by an appropriate padding set for the mass-impregnated paper cable. Suitable for compression connectors.

Characteristics

- Reliable stress control due to flexible silicone stress control elements
- Wide cross-section range
- Quick, safe and easy assembly
- Ready for immediate operation

Application/Suitability

- Indoor
- Outdoor
- Underground
- Water
- Installation ducts
- Ductwork

Voltage level

- U_0/U_m (U_m) 12/20 (24) kV - 19/33 (36) kV

Test standards

- CENELEC HD 629.2 (DIN VDE 0278, part 629-2)

Storage conditions/Shelf life

- Unlimited shelf life



Dimensions

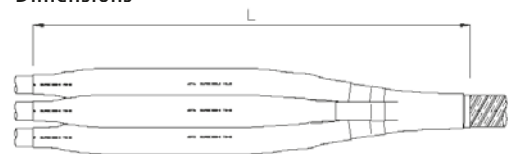

Scope of delivery

Spreader cap, thick wall heat shrinkable outer tube with hot melt adhesive, oil barrier tubing, heat shrinkable tubes, silicone stress control elements, earthing wire, copper braid tape, pressure spring, assembly material, sealing tape, field control filling tape (blue), fire protection wrapping, assembly instructions

Optional accessory: Compression connectors (see Connecting technology)

Type	L mm	min. Ø over core insulation after re- moval of the outer conductive layer mm	max. Connector- Ø mm	max. Connector length mm	24 kV	36 kV	Art.-No.
					Nominal cross section mm ²		
U_0/U_m (U_m) 12/20 (24) kV - 12.7/22 (24) kV							
CHMP(3Pb)3-1 24kV	16-25	1200	12.6	20	100	16 - 25	197631
	35-95	1200	17.3	25	110	35 - 95	197632
	95-240	1200	19.9	34	150	95 - 240	197633 ¹⁾
	185-300	1200	23.1	40	150	185 - 300	197634
U_0/U_m (U_m) 18/30 (36) kV - 19/33 (36) kV							
CHMP(3Pb)3-1 36kV	35-50	1200	19.9	20	110		197635
	70-150	1200	23.1	25	150		197636 ²⁾
	150-300	1200	27.3	38	160		197637 ³⁾

¹⁾ Padding kit PS(3Pb+Pb), (Art.-No.197699) to be used for 35 - 70 mm² (24 kV).

²⁾ Padding kit PS(3Pb+Pb), (Art.-No.197701) to be used for 35 - 50 mm² (36 kV).

³⁾ Padding kit PS(3Pb+Pb), (Art.-No.197702) to be used for 70 - 150 mm² (36 kV).



CHMP(3Pb)3 Transition joint

for 3 lead sheath cables to 3-core polymeric cables

Hybrid transition joints CHMP(3Pb)3 for transition to one 3-core polymeric-insulated cables are suitable for all 3 lead sheath cables up to 36 kV. The scope of application can be reduced by an appropriate padding set for the mass-impregnated paper cable. Suitable for compression connectors.

Characteristics

- Reliable stress control due to flexible silicone stress control elements
- Wide cross-section range
- Quick, safe and easy assembly
- Ready for immediate operation

Application/Suitability

- Indoor
- Outdoor
- Underground
- Water
- Installation ducts
- Ductwork

Voltage level

- U_0/U_m (U_m) 12/20 (24) kV - 19/33 (36) kV

Test standards

- CENELEC HD 629.2 (DIN VDE 0278, part 629-2)

Storage conditions/Shelf life

- Unlimited shelf life



Dimensions

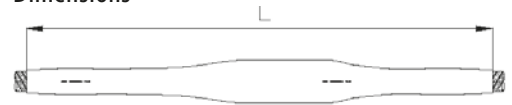

Scope of delivery

Spreader cap, thick wall heat shrinkable outer tube with hot melt adhesive, oil barrier tubing, heat shrinkable tubes, silicone stress control elements, earthing wire, copper braid tape, pressure spring, assembly material, sealing tape, field control filling tape (blue), fire protection wrapping, assembly instructions

Optional accessory: Compression connectors (see Connecting technology)

Type	L mm	min. Ø over core insulation after re- moval of the outer conductive layer mm	max. Connector- Ø mm	max. Connector length mm	24 kV	36 kV	Art.-No.
					Nominal cross section mm ²		
U_0/U_m (U_m) 12/20 (24) kV - 12.7/22 (24) kV							
CHMP(3Pb)3 24kV	16-25	1400	12.6	20	100	16 - 25	197641
	35-95	1400	17.3	25	110	35 - 95	197642
	95-240	1400	19.9	34	150	95 - 240	197643 ¹⁾
	185-300	1400	23.1	40	150	185 - 300	197644
U_0/U_m (U_m) 18/30 (36) kV - 19/33 (36) kV							
CHMP(3Pb)3 36kV	35-50	1400	19.9	20	110		197645
	70-150	1400	23.1	25	150		197646 ²⁾
	150-300	1400	27.3	38	160		197647 ³⁾

¹⁾ Padding kit PS(3Pb+Pb), (Art.-No.197699) to be used for 35 - 70 mm² (24 kV).

²⁾ Padding kit PS(3Pb+Pb), (Art.-No.197701) to be used for 35 - 50 mm² (36 kV).

³⁾ Padding kit PS(3Pb+Pb), (Art.-No.197702) to be used for 70 - 150 mm² (36 kV).



CHMPPR3 Straight-through joint

for belted cables/H-Type cables up to 17.5 kV (MIND)

Hybrid straight-through joints CHMPPR3 are suitable for belted cables and H-Type cables up to 17.5 kV. Suitable for compression connectors.

Characteristics

- Wide cross-section range
- Quick, safe and easy assembly
- Ready for immediate operation

Application/Suitability

- Indoor
- Outdoor
- Underground
- Water
- Installation ducts
- Ductwork

Voltage level

- U_0/U_m 6/10 (12) kV - 8.7/15 (17.5) kV

Test standards

- CENELEC HD 629.2 (DIN VDE 0278, part 629-2)

Storage conditions/Shelf life

- Unlimited shelf life

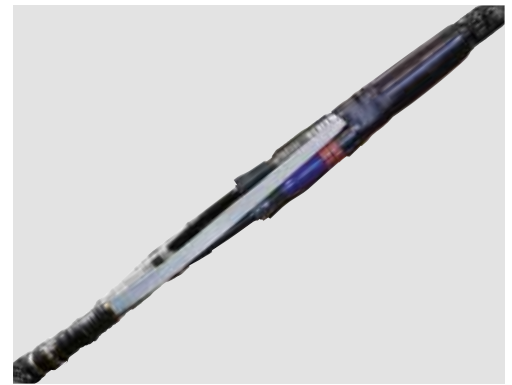

Dimensions

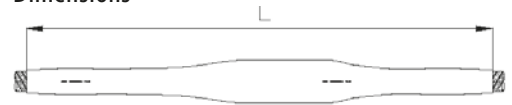

Scope of delivery

Spreader cap, thick wall heat shrinkable outer tube with hot melt adhesive, oil barrier tubing, heat shrinkable tubes, earthing wire, copper braid tape, pressure spring, assembly material, sealing tape, field control filling tape (blue), fire protection wrapping, assembly instructions

Optional accessory: Compression connectors (see Connecting technology)

MEDIUM VOLTAGE
Cable sets for mass-impregnated paper cables

Type	L mm	12 kV			17.5 kV			Art.-No.	
		Nominal cross section mm ²	max. Connector-Ø mm	max. Connector length mm	Nominal cross section mm ²	max. Connector-Ø mm	max. Connector length mm		
U_0/U_m 6/10 (12) kV - 8.7/15 (17.5) kV									
CHMPPR3 17kV	35-50	1400	35 - 70	25	130	35 - 50	20	110	197658
	70-240	1400	95 - 240	34	145	70 - 240	34	145	197659
	240-400	1400	300 - 400	42	170	240 - 400	42	170	197660



MEDIUM VOLTAGE

Heat shrinkable components



Heat shrinkable tubes.....	196
----------------------------	-----

**SRBB****Heat shrinkable medium wall tube**

protection for busbar systems and reduction of minimum clearance, halogen-free, shrink ratio 3 : 1

Characteristics

- Medium wall
- Stabilized against UV rays
- Halogen-free
- Tracking resistance in compliance with IEC 112
- Non-corrosive
- Resistant to bacteria and fungi
- Free of lead and cadmium
- Silicone free

Application/Suitability

- Allows for clearance reduction between busbars in medium voltage substations up to 36 kV
- Corrosion protection

Material

- Cross-linked polyolefin

Test standards

- Corresponds to IEC 60684-2

Storage conditions/Shelf life

- Unlimited shelf life

**Scope of delivery**

Medium wall heat shrinkable tube, on spool or in lengths

Note: A standard spool may include sections which have been tied together. Other lengths available on request.

Colours

Red brown

Type	L m	Inner-Ø mm		Recovered wall thickness mm	Art.-No.	
		before shrinking	after shrinking			
Spool Colour: Red brown						
SRBB	19-6	30	19	6	2.3	201942
	35-11	30	35	11	2.5	201943
	50-18	30	50	18	2.7	201944
	80-26	30	80	26	2.8	201945
	120-40	30	120	40	3	201946
Lengths Colour: Red brown						
SRBB	19-6	1	19	6	2.3	237858
	35-11	1	35	11	2.5	237859
	50-18	1	50	18	2.7	237860
	80-26	1	80	26	2.8	237861
	120-40	1	120	40	3	237862

→ Continued on the next page



→ Continuation

SRBB Heat shrinkable medium wall tube

Technical data	Value	Test standard
Physical properties		
Hardness	39 Shore D	DIN 53 505
Elongation at break	500 %	IEC 60684-2
Tensile strength at break	16 MPa	IEC 60684-2
Longitudinal shrinkage	+5 % up to -10 %	IEC 60684-2
Shrink ratio	3:1	IEC 60684-2
Eccentricity expanded	50 %	IEC 60684-2
recovered	85 %	
Thermal properties		
Operating temperature range	-40 °C up to 100 °C	DIN EN 60684-3-283
Shrinkage temperature	> 125 °C	
Burning behaviour	not self-extinguishing	IEC 60684-2 method C
Flexibility at low temperatures	-40 °C	IEC 60684-2
Electrical properties		
Dielectric strength	20 kV/mm	IEC 60684-2
Specific volume resistivity	10 ¹² Ω x cm	IEC 60684-2
Chemical properties		
Corrosion	None	IEC 60684-2
Resistance to fungus and decay	Rate 1	IEC 60684-2

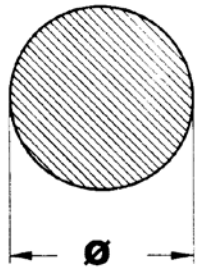
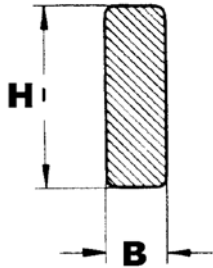
Type	Recommended application range Busbar types: round shaped Diameter [Ø] mm		Recommended application range Busbar types: rectangular shaped Width [B] + Height [H] mm	
	min.	max.	min.	max.
SRBB	19-6	6.5	12	18
	35-11	13	22	36
	50-18	18	31	60
	80-26	28	55	95
	120-40	45	80	150
				

Minimum allowance between the busbars

Busbar types	Minimum allowance mm			
	12 kV	17.5 kV	24 kV	36 kV
round shaped				
without insulation PH/PH and PH/E	120	160	220	320
with insulation PH/PH	50	65	90	145
with insulation PH/E	60	80	120	200
rectangular shaped				
without insulation PH/PH and PH/E	120	180	220	320
with insulation PH/PH	60	80	110	195
with insulation PH/E	70	100	145	280

**SRAT****Heat shrinkable thick wall tube**

halogen-free, shrink ratio 3 : 1

Characteristics

- Thick wall
- Stabilized against UV rays
- Halogen-free
- Non-corrosive
- Infusible
- Highly resistant to electrical breakdown
- Tracking resistance
- High tensile strength
- Free of lead and cadmium
- Silicone free

Application/Suitability

- Insulation tube for conductors in cable terminations of 3.6 to 42 kV

- Corrosion protection

Material

- Cross-linked polyolefin

Test standards

- Corresponds to IEC 60684-2

Storage conditions/Shelf life

- Unlimited shelf life

**Scope of delivery**

Thick wall heat shrinkable tube, on spool or in lengths

Note: A standard spool may include sections which have been tied together.
Other lengths available on request.

Colours

Red brown

Type	L m	Inner-Ø mm		Recovered wall thickness mm	Art.-No.	
		before shrinking	after shrinking			
Spool Colour: Red brown						
SRAT	19-6	30	19	6	3	144884
	29-9	30	29	9	3	144882
	38-12	30	38	12	3.1	144880
	48-15	30	48	15	3.1	144878
	60-20	30	60	20	3.1	144886
	80-26	30	80	26	3.1	144876
Lengths Colour: Red brown						
SRAT	19-6	1	19	6	3	144888
	29-9	1	29	9	3	144892
	38-12	1	38	12	3.1	144898
	48-15	1	48	15	3.1	132464
	60-20	1	60	20	3.1	144921
	80-26	1	80	26	3.1	144935
	120-40	1	120	40	3.1	144943



→ Continuation







SRAT Heat shrinkable thick wall tube

Technical data	Value	Test standard
Physical properties		
Hardness	44 Shore D	DIN 53505
Elongation at break	350 %	IEC 60684-2
Tensile strength at break	12 MPa	IEC 60684-2
Longitudinal shrinkage	+5 % bis -10 %	IEC 60684-2
Shrink ratio	3:1	IEC 60684-2
Eccentricity expanded	60 %	IEC 60684-2
recovered	85 %	
Thermal properties		
Operating temperature range	-40 °C bis 100 °C	IEC 60684-2
Shrinkage temperature	> 125 °C	
Flame propagation	burning time <1 s	IEC 60684-2 method C
Flexibility at low temperatures	-40 °C	IEC 60684-2
Thermal ageing (168 h at 150 °C)		
Elongation at break	300 %	IEC 60684-2
Tensile strength at break	11 MPa	
Electrical properties		
Dielectric strength	20 kV/mm	IEC 60684-2
Resistance to tracking	class 2A 2.5 kV – 1 h 2.75 kV – 1 h 3.0 kV – 1 h 3.25 kV – 20 min	IEC 60684-2
Chemical properties		
Resistance to mould growth		
Elongation at break	350 %	IEC 60684-2
Tensile strength at break	10 MPa	
Weather resistance		
Elongation at break	250 %	IEC 60684-2
Tensile strength at break	9 MPa	
	class 2A 2.5 kV – 1h	

Remarque: Toutes modifications techniques réservées.

CONNECTING TECHNOLOGY

Low and Medium Voltage

	Compression connectors	202
	Compression cable lugs	204
	Screw connectors	206
	Screw cable lugs	207
	Branch ring connectors	208
	Miscellaneous	210



DV-CU-V

Compression connector Cu

according to DIN 46267, without separator, for low voltage

Strain-relieving connector (hexagonally compressed) for copper conductors, suitable for joints.

Material

- Copper tin-plated

Application/Suitability

- Connector for RM/SM (Class 2) copper conductors according to DIN EN 60228 (VDE 0295)

Construction standard

- DIN 46267, Part 1, non tension-proof press connections for copper conductors



Scope of delivery

Compression connector

Note: To be used with suitable crimping tool with DIN inserts.

Dimensions

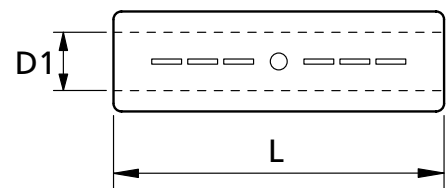

- L = Length
- D1 = Centric borehole
- K = Die code no.-outer diameter
- RM = Round, stranded
- SM = Sector-shaped, stranded

Type	L mm	D1 mm	Nominal cross section mm ²	K mm	Art.-No.
DV-CU-V	6	30	3.8	5	125895
	10	30	4.5	6	125950
	16	50	5.5	8	125951
	25	50	7.0	10	125952
	35	50	8.2	12	125953
	50	56	10.0	14	125954
	70	56	11.5	16	125955
	95	70	13.5	18	125956
	120	70	15.5	20	125957
	150	80	17.0	22	125958
	240	90	21.5	28	125960



DVZ-CU-V-LD

Compression connector Cu

according to DIN 46267, with separator, for low voltage

Strain-relieving connector (hexagonally compressed) with a separator for copper conductors, suitable for joints.

Material

- Copper tin-plated

Application/Suitability

- Especially for transition joints and pot end joints
- Connector for RM/SM (Class 2) copper conductors according to DIN EN 60228 (VDE 0295)

Construction standard

- DIN 46267, Part 1, non tension-proof press connections for copper conductors



Scope of delivery

Compression connector

Note: To be used with suitable crimping tool with DIN inserts.

Dimensions

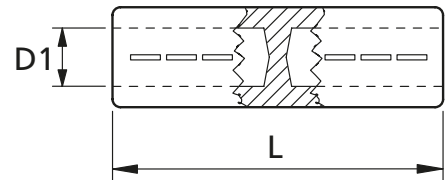

L = Length
 D1 = Centric borehole
 K = Die code no.-outer diameter
 RM = Round, stranded
 SM = Sector-shaped, stranded

Type	L mm	D1 mm	Nominal cross section mm ²	K mm	Art.-No.
DVZ-CU-V-LD	6	30	3.8	6	166374
	10	30	4.5	6	125966
	16	50	5.5	8	125897
	25	50	7.0	10	125898
	35	50	8.2	12	125899
	50	56	10.0	14	125900
	95	70	13.5	18	125902
	150	80	17.0	22	125904
	185	85	19.0	25	125905
	240	90	21.5	28	125906



DK-CU-V

Compression cable lug Cu

according to DIN 46235, for low and medium voltage

Cable lug (hexagonally compressed) for copper conductors, suitable for indoor cable terminations.

Material

- Copper tin-plated

Application/Suitability

- Cable lug recommended for copper conductors RM/SM (class 2) according to DIN EN 60228 (VDE 0295)

Standards

- Construction standard: DIN 46235
- Testing standard: DIN EN/IEC 61238



Scope of delivery

Compression cable lug

Note: To be used with suitable crimping tool with DIN inserts

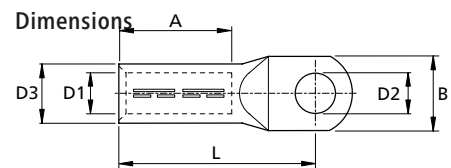

- L = Length
- B = Width
- D1 = Centric borehole
- D2 = Plate bore diameter
- D3 = Press insert outside diameter
- A = Length hole drilling
- RM = Round, stranded
- SM = Sector-shaped, stranded
- K = Die code no.-outer diameter

Type	L mm	B mm	D1 mm	D2 mm	D3 mm	K mm	A mm	Nominal cross section mm ²	Art.-No.
6/6	24	8,5	3,8	6,4	5,5	5	10	6	126040
10/8*	27	13	4,5	8,4	6,0	6	12	10	126044
16/8	36	13	5,5	8,4	8,5	8	20	16	126046
16/10	36	17	5,5	10,5	8,5	8	20	16	126047
16/12*	36	18	5,5	13,0	8,5	8	20	16	126048
25/10	38	17	7,0	10,5	10,0	10	20	25	126051
25/12	38	19	7,0	13,0	10,0	10	20	25	126052
35/10	42	19	8,2	10,5	12,5	12	20	35	126054
35/12	42	21	8,2	13,0	12,5	12	20	35	126055
50/10	52	22	10,0	10,5	14,5	14	28	50	126059
50/12	52	24	10,0	13,0	14,5	14	28	50	126060
70/10	55	24	11,5	10,5	16,5	16	28	70	126064
95/12	65	28	13,5	13,0	19,0	18	35	95	126070
120/12	70	32	15,5	13,0	21,0	20	35	120	126074
150/12	78	34	17,0	13,0	23,5	22	40	150	126080
150/16	78	34	17,0	17,0	23,5	22	40	150	126082
185/12	82	37	19,0	13,0	25,5	25	42	185	126085
185/16	82	37	19,0	17,0	25,5	25	42	185	126087
240/12	92	42	21,5	13,0	29,0	28	42	240	126089
240/16	92	42	21,5	17,0	29,0	28	42	240	126091
300/14*	100	48	24,5	15,0	32,0	32	52	300	126093
400/16	115	55	27,5	17,0	38,5	38	70	400	126096
500/16*	125	60	31,0	17,0	42,0	42	70	500	126098
625/16*	135	60	34,5	17,0	44,0	44	80	625	126099

* Connection bolt diameter not according to DIN 46235



DK-AL-LD

Compression cable lug Al

according to DIN 46235, longitudinally sealed, for low and medium voltage

Cable lug (hexagonally compressed) for aluminium conductors, suitable for indoor and outdoor cable terminations.

Material

- Blank aluminium

Application/Suitability

- Cable lug for aluminium conductor RM/SM (Class 2), RE and SE (Class 1) according to DIN EN 60228 (VDE 0295)

Construction standard

- DIN 46329, cable lugs for press connections (contact plate for aluminium)



Scope of delivery

Compression cable lug

Note: To be used with suitable crimping tool with DIN inserts

Dimensions

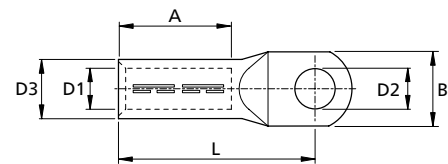

- L = Length
- B = Width
- D1 = Centric borehole
- D2 = Plate bore diameter
- D3 = Press insert outside diameter
- A = Length hole drilling
- RM = Round, stranded
- SM = Sector-shaped, stranded
- RE = Round, massive
- SE = Sector-shaped, massive
- K = Die code no.-outer diameter

Type	L mm	B mm	D1 mm	D2 mm	D3 mm	K mm	A mm	RM/SM	RE	SE	Art.-No.
								Nominal cross section mm ²			
DK-AL-LD	70/12	72	25	11,2	13,0	18,5	18	52	70	95	194942
	95/12	75	25	12,6	13,0	22,0	22	56	95	120	194941
	120/12	80	30	14,7	13,0	23,0	22	56	120	150	194939
	150/16	90	30	16,3	17,0	25,0	25	60	150	185	194936
	185/12	91	30	18,3	13,0	28,5	28	60	185	240	194935
	185/16	91	30	18,3	17,0	28,5	28	60	185	240	194934
	240/16	103	38	21,0	17,0	32,0	32	70	240	300	194933
	300/16	103	38	23,3	17,0	34,0	34	70	300		194932

* Not according to DIN 46329

**CSV-T****Screw connector for Cu and Al**

longitudinally sealed, with shear head bolts, with separator, for low voltage

Screw connector for RM/SM/RE/SE aluminium and copper conductors, suitable for straight-through and transition joints.

Material

- Aluminium tin-plated

Application/Suitability

- For connecting conductors RM/SM (class 2), RE/SE (class 1) according to DIN EN/IEC 60228 (VDE 0295)

Test standards

- IEC 61238-1

**Scope of delivery**

Screw connector, assembly instructions

Note: BBC Cellpack counter-holder recommended for installation (see Accessories).

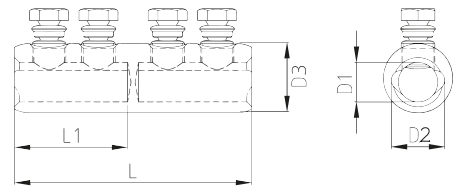
Dimensions

L = Length

L1 = Borehole depth

D1 = Centric borehole diameter

D2 = Sector-shaped borehole diameter

D3 = Outer diameter

RM = Round, stranded

SM = Sector-shaped, stranded

RE = Round, massive

SE = Sector-shaped, massive

Type		L mm	L1 mm	D1 mm	D2 mm	D3 mm	Number of bolts	Art.-No.
CSV-T	6-50	40	18.5	9	11.0	18	2	255406
	16-95	60	28	12.5	16.0	24	2	255408
	50-150	70	33	16.0	21.0	28	2	267708
	95-240	120	58	20.0	27.0	35	4	266811
	240-400	150	73	26.0	30.0	42	4	289677



CSK

Screw cable lug for Cu and Al

longitudinally sealed, with shear head bolts, for low and medium voltage

Screw cable lug for RM/SM/RE/SE aluminium and copper conductors, suitable for indoor and outdoor terminations.

Material

- Aluminium tin-plated

Application/Suitability

- For connecting conductors RM/SM (class 2), RE/SE (class 1) according to DIN EN/IEC 60228 (VDE 0295

Test standards

- IEC 61238-1



Scope of delivery

Screw cable lug, assembly instructions

Note: BBC Cellpack counter-holder recommended for installation (see Accessories). Application according to AWG, ISWG and BWG standards on request.

Dimensions

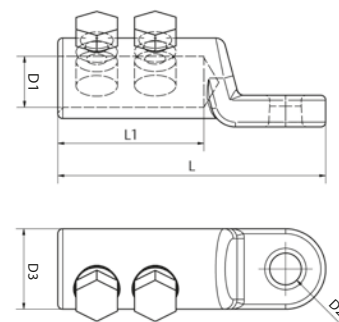

L = Length

L1 = Length centric bore hole

D1 = Bore hole diameter

D2 = Plate bore diameter

D3 = Outer diameter

RM = Round, stranded

SM = Sector-shaped, stranded

RE = Round, massive

SE = Sector-shaped, massive

Type		L mm	L1 mm	D1 mm	D2 mm	D3 mm	Number of bolts	Art.-No.
CSK	6-50	65	30	9.4	13	22	1	374490
	16-95	65	30	12.5	13	22	1	374491
	50-150	80	35	16	13	28	1	374492
	95-240	110	60	20	13	33	2	374493
	95-240 DM17	110	60	20	17	33	2	374494
	240-400	135	75	26	16.5	40	2	374495



HE 1/70/150 Branch clamp

for low voltage

For branching of 4-core SM/SE low voltage cables up to 1 kV.

Characteristics

- Consists of sectional blocks with contacts, separators and inner hexagonal screws
- Connection of branch cable in visible area above the main cable
- Can be installed / operated while under voltage
- Safe and easy to handle

Material

- Fixing system: Aluminum blank
- Contact system: Brass tinned

Application/Suitability

- House connections
- SM (Class 2)/SE (Class 1) according to DIN EN/IEC 60228 (VDE 0295)



Scope of delivery

Branch clamp, insulating wedges, assembly instructions

SM = Sector-shaped, stranded
 SE = Sector-shaped, massive
 RM = Round, stranded

Type	Number of conductors	Nominal cross section Main cable mm ²		Nominal cross section Branch cable SE,SM, RM mm ²	Art.-No.
		SE	SM		
HE 1/70/150	4	95 - 150	70 - 120	16 - 50	193644

CONNECTING TECHNOLOGY



Compact ring clamp Branch clamp

for low voltage

Branch clamp for aluminium sector shaped conductors.

Characteristics

- Contact screws can be accessed from the side or from above
- No stripping of wires
- Can be installed / operated while under voltage
- Safe and easy to handle

Material

- Aluminium blank

Application/Suitability

- For 3- or 4-core cables with PVC, XLPE (VPE) EPR insulation
- RM (class 2), SE (class 1) according to DIN EN/IEC 60228 (VDE 0295)



D = Circumscribed diameter
RM = Round, stranded
SE = Sector-shaped, massive

Scope of delivery

Branch clamp

Type	Number of conductors	D mm	Cu/RM	Al/SE	Branch cable	Width across flat mm		Art.-No.	
			Cross section mm ²			1	2		
Compact ring clamp	3x16-25/50	3	87	16 - 25		6 - 50	6	5	126194
	3x50/50	3	87	50 - 50		6 - 50	6	5	126195
	3x95/50	3	92	95 - 95		6 - 50	6	5	126197
	3x95/50-120/50	3	87	95 - 120	150	16 - 50	6	5	126196
	3x150/50	3	92	150 - 150		6 - 50	6	5	126200
	3x150/150	3	126	150 - 150		50 - 150	8	8	126199
	4x16/50	4	83	16 - 16		6 - 50	6	5	126202
	4x25/50	4	83	25 - 25	35	6 - 50	6	5	126204
	4x35/50	4	83	35 - 35	50	6 - 50	6	5	126205
	4x50/50	4	83	50 - 50	70	6 - 50	6	5	126206
	4x70/50	4	93	70 - 70	95	6 - 50	6	5	126207
	4x95-120/50	4	93	95 - 120	150	6 - 50	6	5	126208
	4x240se/70	4	124		240	6 - 70	8	5	126211

AK

Screw branch clamp Al-Cu

for cast resin straight-through and branch joints, for low voltage

Suitable for connecting and branching aluminium and copper conductors.

Characteristics

- Brass clamp tin-plated
- Divisible
- Halogen-free

Standards

- EN 60998 -2-1:2004

Scope of delivery

Screw branch clamp

Note: Separable, main cable must not be cut.



Dimensions

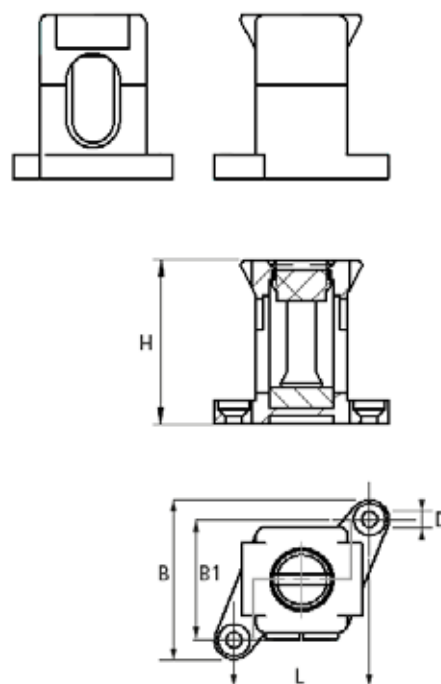

Type	H mm	B mm	B1 mm	L mm	D mm	
AK	6	16.75	29	15	21	3,2
	10	22.75	31	18	23	3,2
	16	26.25	32	21	24	3,2
	25-35	34	36	25	28	3,2

Type	PU Piece	Solid cable max. Nominal cross section mm ²		Stranded cable max. Nominal cross section mm ²		Tightening torque Nm	Art.-No.	
		Main cable	Branch cable	Main cable	Branch cable			
AK	6	12	2.5 - 6	2.5 - 6	2.5 - 4	2.5 - 4	0,8	446312
	10	12	4 - 10	4 - 10	4 - 6	4 - 6	1,2	446313
	16	12	6 - 16	6 - 16	4 - 10	4 - 10	2,5	446314
	25-35	12	16 - 35	16 - 35	10 - 25	10 - 25	2,5	446315

FK Split bolt clamp

for cast resin straight-through and branch joints, for low voltage

For use as branch clamp or connector clamp for copper conductors.

Material

- Electrolyte copper

Scope of delivery

Split bolt clamp



Type	Height mm	Main cable		Nominal cross section Branch cable mm ²	Width across flat in (mm)	Art.-No.
		Cross section mm ²	Diameter mm			
FK	10	10	5.5	2,5 - 10	0.75 (19)	410186
	16	16	5.5	2,5 - 16	0.75 (19)	410187
	25	25	6.9	4 - 25	0.75 (19)	410188
	35	35	8.1	4 - 35	0.95 (24)	410189
	50	50	9.6	10 - 50	1.07 (27.3)	410190
	95	70 - 95	14	10 - 95	1.35 (35.3)	410191
	150	120 - 150	16	16 - 150	1.4 (35.55)	410192

V, VI, VS**Screw connector Al-Cu**

for low voltage

Screw connector for aluminium and copper conductors with grub screws.

Characteristics

- V = Blank
- VI = Insulated
- VS = For heat shrinkable cable joints

Material

- Aluminium

Application/Suitability

- Cable conductors RM/SM (class 2), RE and SE (class 1) according to DIN EN/IEC 60228 (VDE 0295)



RM = Round, stranded
 SM = Sector-shaped, stranded
 SE = Sector-shaped, massive
 RE = Round, massive

Scope of delivery

Screw connector

Type		RM	SM	SE	RE	Art.-No.
		Nominal cross section mm ²				
V = Blank						
V	4-16				4 - 16	126169
	16-50				16 - 50	126170
VI = Insulated						
VI	4-16				4 - 16	126172
	16-50				16 - 50	126164
	50-150			50 - 95	50 - 150	126165
VS = For heat shrinkable cable joints						
VS	4-50	4 - 35	4 - 35	4 - 50	4 - 50	126214

KP**Branch clamp**

for cast resin branch joints, for low voltage

Used for branching of copper cables and signal conductors.

Characteristics

- Plastic insulating housing with tinplated cutting contact
- Insulated cable exit allows assembly under voltage

**Scope of delivery**

Branch clamp

Type	W mm	H mm	Nominal cross section mm ²		Art.-No.	
			main cable	branch cable		
KP	1.5-10	23	20	1.5 - 10	1.5 - 10	126216

AVS Wire connector

for telecommunication and signal cables, DIN 47627

Suitable for connecting polymeric-insulated telecommunication and signal cables e.g. in heat shrinkable telecommunication joints, as well as for modern building management systems (such as communication, telephone or surveillance systems and bus systems).

Characteristics

- Grease-filled to protect against corrosion
- Shock-resistant polymeric housing
- Reliable connection due to U contact principle
- Stripping, connection and insulation carried out in a single step
- Space-saving design, easy assembly
- High electrical insulating values
- High mechanical and thermal strength

Application/Suitability

- Not suitable for cable conductor class 5 (according to DIN EN/IEC 60228)



Colours



Transparent

Types

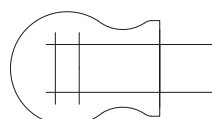

AVS2-9

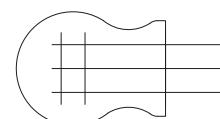

AVS3-9

Scope of delivery

Wire connector

Note: For compression and a proper conductor/connector contact, use a suitable crimping tool.

Type		Number of conductors	Conductor-Ø mm	Core-Ø mm	Art.-No.
AVS	2-9	2	0.4 - 0.9	2	145624
	3-9	3	0.4 - 0.9	2	145622

Technical data	Value	Test standard
Insulation resistance	106 MΩ	DIN 47627
Voltage strength between conductors	500 V	DIN 47627
Modification of contact resistance	2 mΩ	DIN 47627
Surge voltage resistance	5 kV	DIN 47627
Impulse current resistance	no burn marks in contact area	DIN 47627

DR, DR-L Heat shrinkable crimp connector

insulated with heat shrinkable tube, with adhesive, for low voltage

Durable and reliable connector for application in areas under extreme conditions. Hot melt adhesive completely seals the connection area.

Characteristics

- 100 % waterproof
- Superior electrical properties
- High mechanical strength

Application/Suitability

- Indoor

Note

- Length tolerance $\pm 4\%$



Scope of delivery

1 PU heat shrinkable crimp connectors

Note: For compression and a proper conductor/heat shrinkable compression connector contact, use a suitable crimping tool.

Colours

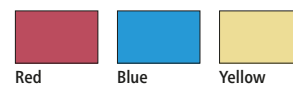

Type		Length mm	Colours	PU Piece	Nominal cross section mm ²	Art.-No.
DR	1	37	Red	20	0.5 - 1.5	456330
	1	37	Red	100	0.5 - 1.5	456333
	2	37	Blue	20	1.5 - 2.5	456331
	2	37	Blue	100	1.5 - 2.5	456334
	3	42	Yellow	20	4 - 6	456332
	3	42	Yellow	100	4 - 6	456335
DR-L	2	55	Blue	20	1.5 - 2.5	456336
	2	55	Blue	100	1.5 - 2.5	456337

Technical data	DR	DR-L
Tensile strength	10.4 MPa	16 MPa
Heat resistance (168 h at 175 °C)	No breaking	No breaking
Heat shock (4 h at 225 °C)	No breaking	No breaking
Temperature range	-40 °C up to 105 °C	-55 °C up to 125 °C
Shrinkage temperature	< 150 °C	< 80 °C
Corrosion	None	None
Water absorption	max. 0.5 %	max. 0.5 %
Max. Voltage	600 V	600 V

CL Earthing clamp

for low voltage

Suitable for armouring and tape screens, for earthing of cable ends and for continuity in straight-through joints.

Material

- Copper tin-plated

Application/Suitability

- Enables solder-free electrical connection for armourings and cable screens



Scope of delivery
Earthing clamp

		Polymeric cable		Art.-No.
		Armoured		
		 4x		
Type		Cross section transition mm ²	Nominal cross section per conductor mm ²	
CL	6	≤ 6	2.5 - 16	126301
	16	≤ 16	16 - 240	126302

EGA**Earthing set for Cable Joints type CHMSV3 & CHMSV3-1**

for connection of polymeric insulated cables with tape screen

EGA earthing set for cable joints CHMSV3 & CHMSV3-1 is suitable for connection of three core cables with copper or aluminum tape screen. Kit components: 3 copper braided tubes and 6 pressure springs.

Characteristics

- Quick, safe and easy assembly
- Superior electrical properties
- High mechanical strength

Application/Suitability

- Earthing continuity and earth bonding
- For cable joints type CHMSV3 & CHMSV3-1
- Enable solder-free electrical connection of metal cable components (cable screen)

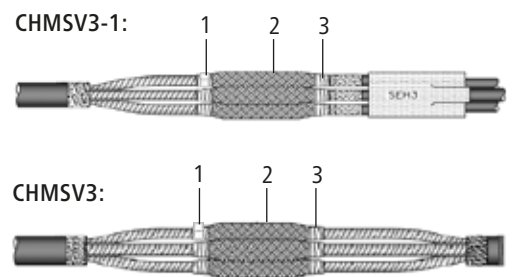

- 1 = Pressure spring
2 = Copper braid
3 = PVC tape

Scope of delivery

1 set for 3 phases: Copper braided tubes, pressure springs RF

Type	L Copper braided tube mm	Pressure spring	Copper braided tube Nominal cross section mm ²	Nominal cross section mm ²				Art.-No.	
				12 kV	17.5 kV	24 kV	36 kV		
EGA	1	400	RF2	35	25 - 95 70 - 150	25 - 95	16 - 95	-	420576
	2	500	RF3	35	-	70 - 150	50 - 150	50 - 150	420577
	3	450	RF3	35	95 - 240	95 - 240	95 - 240	-	420578
	4	500	RF4	35	-	-	-	95 - 240	420646
	5	600	RF4	35	240 - 400	240 - 400	240 - 400	240 - 400	420647

* The earthing set must be selected according to the nominal cross section of the selected joint.

EGA

Earthing set for cable terminations

for cables with tape screen and/or armouring for cable terminations, for low and medium voltage

EGA earthing set for cable terminations for 1-core cables with copper tape or aluminium screen (Fig. 1) and for unarmoured 3-core cables (Fig. 3).

Kit components: 3 flat-rolled copper earth braids and 3 pressure springs.

Characteristics

- Quick, safe and easy assembly
- Superior electrical properties
- High mechanical strength

Application/Suitability

- Earthing continuity and earth bonding
- For cast resin, heat shrinkable and slip-on cable accessories
- Enables solder-free electrical connection of metal cable components (screen, armouring, metal sheath)

Termination types

- ① 1-core cables with copper tape or aluminium screens unarmoured
- ② 1-core cables with copper tape or aluminium screens armoured, please order extra pressure spring (ZR1)
- ③ 3-core cables with copper tape or aluminium screens unarmoured
- ④ 3-core cables with copper tape or aluminium screens armoured, please order extra pressure spring (ZR2)



Termination types

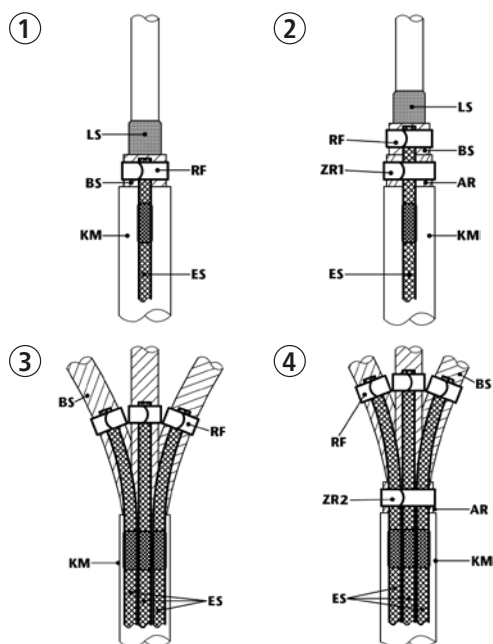

LS = External conducting layer
 BS = Cu-tape screen
 KM = Cable sheath
 RF = Type RF pressure spring
 ES = Copper earth braid, flat tin-plated
 AR = Armouring
 ZR1 = Extra pressure spring 1-core
 ZR2 = Extra pressure spring 3-core

Scope of delivery

1 set for 3 phases: Copper earth braids, pressure springs RF

Note: Additional pressure springs RF (ZR1/ZR2) for armoured cables to be ordered separately (see Accessories).

Type	L mm	Pressure spring	Copper earth braids		Nominal cross section mm ²					ZR1	ZR2	Art.-No.	
			Ø hole mm	Nominal cross section mm ²	7.2 kV	12 kV	17.5 kV	24 kV	36 kV				
EGA	16-2	500	RF 2	8.5	16	150	120	70	50		RF3	RF5	143502
	16-3	500	RF 3	8.5	16	150 - 240	120 - 240	95 - 185	70 - 150	120	RF4	RF5	143503
	25-3	500	RF 3	10.5	25	150 - 500	120 - 500	95 - 300	70 - 300	70 - 240	RF4	RF6	143505
	25-4	500	RF 4	10.5	25					150 - 300	RF5	RF6	143506
	35-4	500	RF 4	10.5	35	500 - 1000	500 - 1000	400 - 800	300 - 800	185 - 500	RF5	RF6	143508
	35-5	500	RF 5	10.5	35			800 - 1000	800 - 1000	500 - 1000	RF6		143509

EGA-CCMSV-AFS

Earthing kit

for application on polymeric cables up to 36 kV

EGA-CCMSV-AFS earthing kit for all-in-one cold-shrink cable straight through joints of type CCMSV for 1- core cables of type: RH5Z1, NF C 33-226, XD-ALT, ARE4H5E, ARE1H5E with al-foil screen bonded to the outer sheath.

Characteristics

- Quick, safe and easy assembly
- Ensure good electrical connection

Application/Suitability

- Earthing continuity
- Indoor/Outdoor

Voltage level

- U_0/U_m 6/10 (12) kV – 18/30 (36) kV

Test standard

- CENELEC HD 629.1

Storage conditions/Shelf life

- Unlimited shelf life



Scope of delivery

Contact plate, stainless-steel cable ties, installation instructions

Type		Nominal cross section mm ²				Art.-No.
		6/10 (12) - 6,35/11 (12) kV	8,7/15 (17,5) kV	12/20 (24) - 2,7/22 (24) kV	18/30 (36) kV	
EGA-CCMSV-AFS	EGA-1	95 150-240	70-95 95-185	35-95 95-150	25-70	461184
	EGA-2	240-300 400 400-630	150-240 185-300 300-400 400-500	95-240 120-300 240-400 300-500	35-95 35-150 95-240 240-400 300-400	461182
	EGA-3	-	630	630	400-630	461183

* The earthing set must be selected according to the nominal cross-section of the selected joint.

AUF**Armour transition for 3-core joints**

for armoured cables, for medium voltage

Armour continuity set for armoured 3-core cable joints.

Characteristics

- Quick, safe and easy assembly
- Superior electrical properties
- High mechanical strength

Application/Suitability

- Earthing continuity and earth bonding
- For cast resin, heat shrinkable and slip-on cable accessories
- Enables solder-free electrical connection of metal cable components (screen, armouring, metal sheath)

**Scope of delivery**

1 set for 3 phases: Copper braid, pressure springs RF

Dimensions

L = Length

1. Pressure spring

2. Copper braid

3. Pressure spring

Type	L mm	Pressure spring	Copper cord Nominal cross section mm ²	Nominal cross section mm ²					Art.-No.	
				7.2 kV	12 kV	17.5 kV	24 kV	36 kV		
AUF	5	1200	RF 5	35	300	240	240	150	70	195367
	6	1200	RF 6	35	400	300 - 400	300 - 400	185 - 300	95 - 300	195368

Padding-Kit

Kit for reducing the cross-section of joints

for joints for medium voltage mass-impregnated paper cable

Characteristics

- Quick, safe and easy assembly

Application/Suitability

- For cables with big difference of cross-sections
- For connection of polymeric insulated cables with mass-impregnated paper cables
- For the following cable types: belted cable, H-cable, lead sheath cable and similar

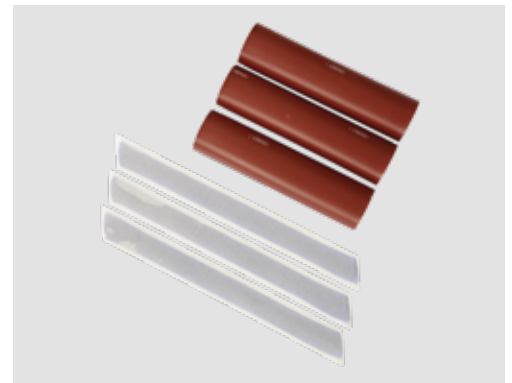

Scope of delivery

Heat shrinkable tubes, Oil barrier tubing, Mastic tape

Type	Application	Nominal cross-section polymeric insulated cable mm ²				min. Ø over core insulation mm ²	Nominal cross-section mass-impregnated paper cable mm ²	Art.-No.
		6/10 (12) kV	8.7/15 (17.5) kV	12/20 (24) kV	18/30 (36) kV			
PS(G+H)	CHMPR3 CHMPR3-1	95-300				17.3	(25*) 35-70	197690
			70-240			17.3	25-50	
PS	CHMPRSV 3-1 (VM)		95-240			17.3	35-70	298442
		95-240				17.3	35-70	
PS(H)	CHMP(H)3 CHMP(H)3-1			95-240		19.9	35-70	197692
PS(3PB+PB)	CHMP(3Pb)3			95-240		19.9	35-70	197699
PS(3PB+PB)	CHMP(3Pb)3 CHMP(3Pb)3-1				95-240	23.1	35-70	197701
PS(3Pb+Pb)	CHMP(3Pb)3 CHMP(3Pb)3-1				150-300	27.3	70-150	197702

RF

Pressure spring

for permanently elastic contact

Characteristics

- Corrosion-resistant
- Fatigue-proof
- Guarantees consistent radial contact stress

Application/Suitability

- For cast resin, heat shrinkable and slip-on cable accessories
- Enables solder-free electrical connection of metal cable components (screen, armouring, metal sheath) and earthing elements (copper grounding wire, cooper mesh joint etc.)

Note

- Pressure springs are no current-carrying parts.

Material

- Special stainless steel

**Colours**



Brass

Scope of delivery

Pressure spring PU 10

Type	Width mm	Cable-Ø mm	Outer-Ø mm	Art.-No.
RF	0	6 - 10	5.7	456338
	0.5	9 - 14	8.5	456339
	1	13 - 22	13.0	456340
	2	17 - 28	17.5	456341
	3	24 - 37	21.5	456342
	4	33 - 49	29.0	456343
	5	44 - 70	37.8	456344
6	55 - 92	51.3	456345	

ELECTRICAL INSULATION AND MOUNTING TAPES

	Electrical insulation and mounting tapes	225
	Additional tapes	238
	Miscellaneous	242

Overview: Cellpack Electrical insulation and mounting tapes / Additional tapes

Products	Properties						
	insulating	self-amalgamating	inscribable	stabilized against UV rays	con- ductive	heat- proof	colour- fast
Electrical insulation and mounting tapes							
No. 128	●	-	-	●	-	-	-
No. 328	●	-	-	●	-	-	-
No. 90	-	-	●	-	-	-	-
No. 64	-	●	-	-	-	-	-
No. 63	-	-	-	-	●	-	-
No. 60, No. 62	●	●	-	●	-	-	-
No. 61	-	●	-	-	●	-	-
Premio 845	-	-	-	●	-	-	-
Premio 1130	●	-	●	-	-	●	-
Premio 1180	●	-	●	-	-	●	-
Premio 2281	-	-	-	-	●	-	-
Premio 5584	-	-	-	●	-	-	-
Additional tapes							
HKB	●	-	-	-	-	-	-
No. 26	-	-	-	-	-	-	●
No. 72	-	●	-	-	-	-	-
KRS	-	●	-	-	-	-	-

- available
- not available



No. 128

PVC insulation tape

for marking, bundling and insulating

Flexible, UV-resistant PVC insulation tape.

Characteristics

- Synthetic rubber adhesive
- Very good resistance to abrasion, corrosion and moisture
- Stabilized against UV rays
- High flexibility
- Withstands high electrical stresses
- Good adhesive properties
- Easy processing
- Oil-resistant
- Resistant to dilute acids and alkalis

Application/Suitability

- Sealing
- Padding of cable insulation
- Bundling
- Reinforcing
- As insulation of electrical and telecommunication cables

Test standards

- Approved according VDE Type IEC 60454-3-1-5/F-PVCP/90 (except transparent)

Material

- PVC



Colours

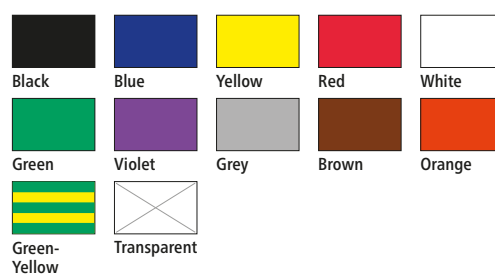

Scope of delivery

PVC insulation tape

Type	Colours	Length m	Width mm	Thickness mm	Art.-No.
No. 128	Black	10	15	0.15	145821
	Blue	10	15	0.15	145825
	Yellow	10	15	0.15	145826
	Red	10	15	0.15	145827
	White	10	15	0.15	145828
	Green	10	15	0.15	145829
	Violet	10	15	0.15	145830
	Grey	10	15	0.15	145831
	Brown	10	15	0.15	145832
	Orange	10	15	0.15	145822
	Green-Yellow	10	15	0.15	145823
	Transparent	10	15	0.15	145824
	Black	10	19	0.15	145806
	Blue	10	19	0.15	145810
	Yellow	10	19	0.15	145811
	Red	10	19	0.15	145812
	White	10	19	0.15	145813
	Green	10	19	0.15	145814
	Violet	10	19	0.15	145815
	Grey	10	19	0.15	145816
	Brown	10	19	0.15	145817
	Orange	10	19	0.15	145807
	Green-Yellow	10	19	0.15	145808

ELECTRICAL INSULATION AND MOUNTING TAPES

→ Continued on the next page



→ Continuation

Type	Colours	Length m	Width mm	Thickness mm	Art.-No.
No. 128	Black	25	19	0.15	145794
	Blue	25	19	0.15	145798
	Yellow	25	19	0.15	145799
	Red	25	19	0.15	145800
	White	25	19	0.15	145801
	Green	25	19	0.15	145802
	Violet	25	19	0.15	145803
	Grey	25	19	0.15	145804
	Brown	25	19	0.15	145805
	Orange	25	19	0.15	145795
	Green-Yellow	25	19	0.15	145796
	Transparent	25	19	0.15	145797
	Black	25	25	0.15	145773
	Transparent	25	25	0.15	145775
	Black	25	30	0.15	145784
	Yellow	25	30	0.15	145787
	White	25	30	0.15	145789
	Grey	25	30	0.15	145792
	Black	25	38	0.15	145771
	Black	25	50	0.15	145772

Technical data	Value	Test standard
min. Elongation at break	170 %	IEC 60454-2
Adhesive strength	1,8 N/cm	IEC 60454-2
Tensile strength	30 N/cm	IEC 60454-2
Dielectric strength	40 kV/mm	IEC 60454-2
Temperature index	0 °C - 90 °C	IEC 60454-2
Unwinding force	1.8 N/cm	IEC 60454-2



No. 328

PVC insulation tape

for insulation and bundling

Particularly flexible and UV-resistant PVC electrical insulation tape.

Characteristics

- High flexibility, even at minus temperatures
- Excellent resistance to oil, abrasion, corrosion and moisture
- Highly resistant to electrical break-down and mechanical protection
- Good sealing properties
- Stabilized against UV radiation
- Good workability even at low temperatures (-18°C to 105°C)
- Resistant to all weather conditions
- Self-extinguishing

Application/Suitability

- Fastening and protection during cable pull-in
- Bundling and reinforcing
- Sealing
- Marking of insulations with high mechanical load requirements
- As insulation in the electrical and telecommunication field

Test standards

- Approval according to VDE IEC 60454-3-1-11/F-PVCP/105

Material

- Soft-PVC



Colours

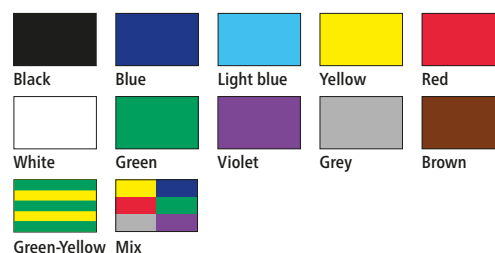

Scope of delivery

PVC insulation tape

Type	Colours	Length m	Width mm	Thickness mm	Art.-No.
No. 328	Black	20	12	0.18	416717
	Black	20	15	0.18	416721
	Black	10	19	0.18	416722
	Black	20	19	0.18	416770
	Blue	20	19	0.18	416771
	Light blue	20	19	0.18	416772
	Yellow	20	19	0.18	416773
	Red	20	19	0.18	416774
	White	20	19	0.18	416775
	Green	20	19	0.18	416776
	Violet	20	19	0.18	416777
	Grey	20	19	0.18	416778
	Brown	20	19	0.18	416779
	Green-Yellow	20	19	0.18	416780
	Mix (Black, Blue, Yellow, Red, White, Green, Violet, Grey, Brown, Green-Yellow)	20	19	0.18	416781
	Black	20	25	0.18	416782
	Black	20	30	0.18	416783
	Black	20	38	0.18	416784
	Grey	20	38	0.18	416785
	Black	20	50	0.18	416786
	Red	20	50	0.18	416787
	White	20	50	0.18	416788
Grey	20	50	0.18	416789	

Technical Data	Value	Test standard
Thickness	0.18 mm	IEC 60454-2
Tensile strength at break	35 N/cm	IEC 60454-2
Elongation at break	300 %	IEC 60454-2
Unwinding force	3.5 N/cm	IEC 60454-2
Adhesion to steel	2,0 N/cm	IEC 60454-2
Adhesion to surfaces	2,4 N/cm	IEC 60454-2
Flammability	Self-extinguishing	IEC 60454-2
Dielectric strength	45 kV/mm	IEC 60454-2
Elastic modulus to 35%	3.5 MPa	IEC 60454-2
Temperature index	-18°C to +105°C	IEC 60454-2

**No. 90****Cotton cloth tape**

for marking and labeling

High quality waterproof sealing cotton cloth tape with synthetic rubber adhesive.

Characteristics

- Synthetic rubber adhesive
- Hard-wearing
- Can be labelled at all times
- Easy to tear
- Easy to unroll
- Superior ageing resistance
- Can be adjusted to suit the form better
- Excellent adherence to a wide range of substances
- Easy processing

Application/Suitability

- Marking
- Labelling
- Affixing
- Bundling

Material

- Coated cotton

**Scope of delivery**

Cotton cloth tape

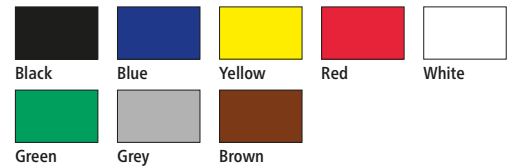
Colours

Type	Colours	Length m	Width mm	Thickness mm	Art.-No.
No. 90	Yellow	50	12	0.31	146016
	White	50	12	0.31	146020
	Grey	50	12	0.31	146024
	Yellow	25	15	0.31	145941
	White	25	15	0.31	145945
	Grey	25	15	0.31	145948
	Black	50	15	0.31	146028
	Yellow	50	15	0.31	146032
	White	50	15	0.31	146036
	Grey	50	15	0.31	146040
	Yellow	25	19	0.31	145954
	White	25	19	0.31	145957
	Grey	25	19	0.31	145961
	Black	50	19	0.31	146044
	Blue	50	19	0.31	146046
	Yellow	50	19	0.31	146048
	Red	50	19	0.31	146050
	White	50	19	0.31	146052
	Green	50	19	0.31	146054
	Grey	50	19	0.31	146056
	Brown	50	19	0.31	146058
	Yellow	25	25	0.31	145967
	White	25	25	0.31	145970
	Grey	25	25	0.31	145973
	Black	50	25	0.31	146060
	Yellow	50	25	0.31	146064
	Red	50	25	0.31	146066
	White	50	25	0.31	146068
	Grey	50	25	0.31	146072
	Black	50	50	0.31	146107
	Yellow	50	50	0.31	146111
	White	50	50	0.31	146115
Grey	50	50	0.31	146119	

Technical data	Value
min. elongation at break	10 %
Adhesion to steel	1.7 N/cm
Unwinding force	2.5 N/cm



No. 64 Sealing tape

for permanently flexible sealing, self-amalgamating

Universally suitable, auto-amalgamating, to seal homogeneously or upholstering cables and conductors.

Characteristics

- Self-amalgamating
- Corrosion-resistant
- Ozone-resistant
- Permanently flexible
- Excellent adherence to metal, glass, rubber and plastic
- Superior physical properties

Application/Suitability

- Sealing of cable and conductor interstices
- Repairing of damaged cable sheaths
- Water-resistant sealing of cable entry points
- Padding of cable insulation
- Suitable for connections using acrylic and epoxy resin compounds
- Protection against dust, moisture and corrosion

Material

- Butyl-/Rubber based



Colours



Black

Scope of delivery

Sealing tape

Type	Colours	Length m	Width mm	Thickness mm	Art.-No.
No. 64	Black	1.5	38	3.2	125591

Technical data	Value
Dielectric strength	23 kV/mm
Specific volume resistivity	$1 \times 10^{12} \text{ M}\Omega$
Tensile strength	0.1 MPa
Heat resistance	-30 C - 80 °C



No. 63

Copper braid tape

for shielding and potential control

Characteristics

- Wrinkle-free application to all contours
- High flexibility
- Unbreakable

Application/Suitability

- Earthing continuity and earth bonding
- Electrostatic shielding continuity
- Semi-conducting continuity for connectors
- Voltage grading continuity

Material

- Braided tinned copper wires



Scope of delivery

Copper braid tape

Colours



Silver

Type	Colours	Length m	Width mm	Thickness mm	Art.-No.
No. 63	Silver	5	25	0.5	126313
	Silver	9.1	25	0.5	126303
	Silver	5	60	0.5	204984
	Silver	10	60	0.5	207247



No. 60, No. 62

High voltage insulation tape

for insulation and padding, self-amalgamating

Characteristics

- Self-amalgamating
- Fuses to form a homogeneous, cavity-free compound within a short period of time
- Fully removable
- Durable
- Ozone-resistant
- Weatherproof
- Stabilized against UV rays
- No electrolytic corrosion
- Non tacky
- Extremely ductile
- Superior electrical properties
- Excellent adherence to a wide range of substances
- Superior physical properties
- Easy processing

Application/Suitability

- Conductor insulation for polymeric insulated cables up to 69 kV
- Padding of cable insulation
- Sealing of casting moulds
- Repairing and connection of various insulating and cable materials e.g. PE, XLPE, EPR, PVC, butyl, neoprene

Material

- EPR-Base

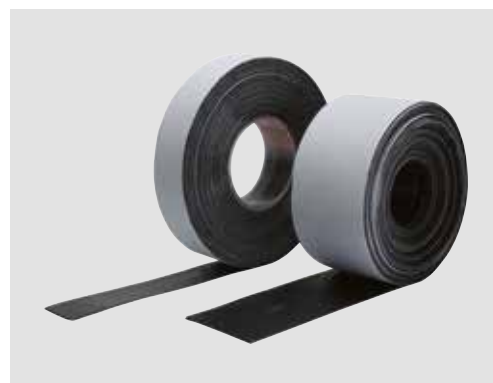

Colours



Black

Scope of delivery

High voltage insulation tape

Type	Colours	Length m	Width mm	Thickness mm	Art.-No.
No. 60	Black	10	19	0.5	125533
No. 62	Black	10	19	0.75	145908
	Black	5	38	0.75	125584
	Black	10	38	0.75	125589

Technical data	Value
min. elongation at break	900 %
Tensile strength at break	3 MPa
Dielectric constant	2.8
Dissipation factor (50 Hz)	0.0050
Dielectric strength	42 kV/mm
Specific volume resistivity	$1 \times 10^{13} \text{ M}\Omega$
Water absorption	0.05 %
Temperature range	
min.	-40 °C
max.	100 °C



No. 61 Conductive tape

to control electric fields, self-amalgamating

Characteristics

- Printed „CAUTION-CONDUCTING TAPE“ to eliminate danger of confusion
- Self-amalgamating
- Fuses to form a homogeneous, cavity-free compound within a short period of time
- Durable
- Ozone-resistant
- No electrolytic corrosion
- Highly flexible
- Superior physical properties

Application/Suitability

- Repairing of semi-conducting layer in medium voltage cables
- Electrical field smoothing
- For smoothing rough surfaces of connectors and cable lugs

Material

- EPR-Base



Scope of delivery
Conductive tape

Colours



Black

Type	Colours	Length m	Width mm	Thickness mm	Art.-No.
No. 61	Black	4.6	19	0.76	125604
	Black	9.1	19	0.76	125590

Technical data	Value
Elongation at break	900 %
Tensile strength at break	3 MPa
Specific volume resistivity	10 Ω x cm
Temperature range	-40 °C up to 100 °C



Premio 845 Tape for cable bundle

for short-circuit-resistant bundling and cable fixing

Fibreglass-reinforced polyester tape on one side coated with adhesive.

Characteristics

- Stable core
- Moisture-resistant
- Stabilized against UV rays
- Extreme tear resistance
- Excellent adhesion to a variety of materials
- Weatherproof

Application/Suitability

- Short-circuit-resistant bundling of cables
- Affixing of cables
- Especially suitable for fixation systems under mechanical tension

Material

- PES/Fibreglass reinforced

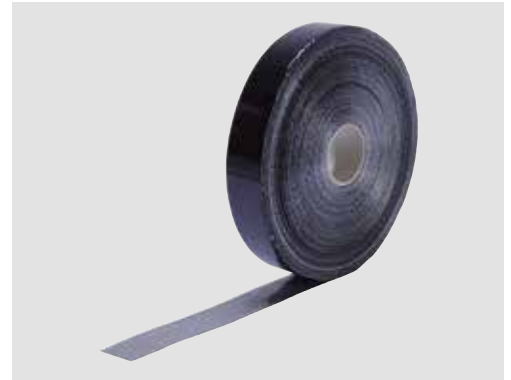

Scope of delivery

Tape for cable bundle

Formular for number of tape layers and bundling distances

$$\text{Maximum distance between 2 bundlings } L_{\max} = 280 \times \frac{d^2}{I}$$

$$\text{Layers of tape } n \text{ for chosen } L_{\max} : n = \frac{I^2 \times L_{\max}}{5700 \times d \times b} + 1$$

I = Short circuit in kA

d = Cable diameter in cm

b = Tape width in cm

L_{\max} = Bundling distances in cm

Colours



Black

Type	Colours	Length m	Width mm	Thickness mm	Art.-No.
Premio 845	Black	20	19	0.18	223592
	Black	50	19	0.18	223591
	Black	50	25	0.18	223590
	Black	50	50	0.18	337978

Technical data	Value
min. Elongation at break	4.5%
Adhesive strength	3.8 N/cm
max. Long-term heat resistance	-30°C to +100°C



Premio 1130

Fibreglass tape 130 °C

for heat-proof electrical and mechanical insulation

Self-adhesive fibreglass tape coated with heat-hardening silicone adhesive, temperature-resistant up to 130 °C.

Characteristics

- Stable core
- Inscrutable
- Extreme tear resistance
- Superior thermal stability

Application/Suitability

- Insulation of highly exothermic electrical components
- As a cable protection during welding and soldering
- As a protection wrapping against radiant heat

Material

- Fibreglass reinforcement



Scope of delivery

Fibreglass tape

Colours



White

Type	Colours	Length m	Width mm	Thickness mm	Art.-No.
Premio 1130	White	33	12	0.17	223585
	White	33	19	0.17	223583

Technical data	Value
min. Elongation at break	8 %
Adhesive strength	3.8 N/cm
Insulation resistance	$1.5 \times 10^3 \text{ M}\Omega$
Dielectric strength	12.7 kV/mm
max. Long-term heat resistance	130 °C



Premio 1180

Fibreglass tape 180 °C

for heat-proof electrical and mechanical insulation

Self-adhesive fibreglass tape coated with heat-hardening silicone adhesive, temperature-resistant up to 180 °C.

Characteristics

- Particularly high temperature resistance
- Excellent mechanical strength
- Very good form adaptability
- Good solvent and paint resistance
- Extreme tear resistance
- Inscrutable
- Stable core

Application/Suitability

- Insulation of highly exothermic electrical components
- As a cable protection during welding and soldering
- As a protection wrapping against radiant heat

Material

- Fibreglass reinforcement



Scope of delivery

Fibreglass tape

Colours



White

Type	Colours	Length m	Width mm	Thickness mm	Art.-No.
Premio 1180	White	33	15	0.17	222581
	White	33	25	0,17	223580

Technical data	Value
Elongation at break	8 %
Adhesive strength	3.8 N/cm
Tensile strength at break	300 N/cm
Insulation resistance	$1.5 \times 10^3 \text{ M}\Omega$
Breakdown voltage	3,0 kV
max. Long-term heat resistance	180 °C



Premio 2281

Copper foil

for discharge of electrostatic charge and screening of components

Copper foil with conductive acrylic adhesive.

Characteristics

- Conductive acrylate adhesive
- Very good corrosion resistance
- Can be soldered
- In practical plastic box

Application/Suitability

- Discharge of electrostatic charge and screening of components and appliances against electro-magnetic fields

Material

- Copper foil



Scope of delivery

Copper foil

Colours



Copper

Type	Colours	Length m	Width mm	Thickness mm	Art.-No.
Premio 2281	Copper	33	9	0.06	223578
	Copper	33	12	0.06	223577
	Copper	33	19	0.06	223576

Technical data	Value
Adhesive strength	4.5 N/cm
Tensile strength	40 N/cm
Heat resistance	-20 °C - 150 °C



Premio 5584

Self-adhesive foam tape

for universal fixation

Double-sided all-purpose foam adhesive tape with high-quality acrylic adhesive.

Characteristics

- Stable core
- Moisture-resistant
- Resistant to dilute acids and alkalis
- High UV-resistance
- Non-corrosive
- Double-sided acrylic adhesive
- High abrasion resistance

Application/Suitability

- Fastening of cable splicing lines
- For protection against electrolytic corrosion
- Waterproofing (minimum compression 20%)
- General adhesive and fastening tape

Material

- Polyethylene foam



Scope of delivery

Self-adhesive foam tape

Colours



White

Type	Colours	Length m	Width mm	Thickness mm	Art.-No.
Premio 5584	White	60	19	1	223575
	White	60	25	1	223574

Technical data	Value
Adhesive strength	7.2 N/cm
Working temperature min.	10 °C
max.	40 °C
Heat resistance min.	-40 °C
max.	100 °C



HKB

Mastic tape

for sealing, self-amalgamating

Characteristics

- Excellent adherence to metal, glass, rubber and plastic
- Superior physical properties
- Superior electrical properties

Application/Suitability

- Reinforcement of heat shrinkable sealed areas
- Sealing of cable terminations for Ceander cables

Material

- Butyl-/Rubber based



Scope of delivery

Mastic tape

Colours



Black

Type	Colours	Length m	Width mm	Thickness mm	Art.-No.
HKB	Black	3	20	3	127651

Technical data	Value
Service temperature	-40 °C - 80 °C
Short-term (up to 1 hour)	200 °C

ELECTRICAL INSULATION AND MOUNTING TAPES



No. 26

Warning tape

for warning of cable presence in case of excavation work

Characteristics

- Printing protected by transparent film
- Durable, elasticity retained at low temperatures
- Colour-fast, luminescent
- Increases the effectiveness of the warning prior to tearing due to 400 % stretchability

Application/Suitability

- Warning about the cables located in the ground (in case of excavation work)

Note

- Optimal position 40 cm above the feeder

Material

- Polyethylene laminated foil



Scope of delivery

Warning tape (Tapes and imprints are available in various colours, see order details.)

Note: Other types available on request.

Colours



Red/White



Yellow



White

Type	Colours	Imprint	Length m	Width mm	Thickness mm	Art.-No.
No. 26	Red/White	without imprint	500	80	0.08	125583
	Yellow	Achtung Starkstromkabel*	250	40	0.15	145865
	Yellow	Achtung Straßenbeleuchtung*	250	40	0.15	145867
	Yellow	Achtung Kabel*	250	40	0.15	145862
	Yellow	Achtung LWL-Kabel*	250	40	0.15	469008
	Yellow	Achtung Fernmeldekabel*	250	40	0.15	145864
	Yellow	Achtung Gasleitungen Attention conduites de gaz Attenzione condotte di gas Danger - Gas pipes Opgelet - Gasleiding Varning Gasledning	250	100	0.10	125628
	White	Achtung - Kabel - Gefahr Attention - câble - danger Attenzione - cavo - pericolo Attention - Cable - Danger Opgelet - Kabel - Gevaar Varning Elkabel	250	100	0.10	125626
	White	Achtung Wasserleitungen Attention Conduites d'eau Attenzione Condotte d'acqua Danger - Water Pipes Opgelet - Waterleiding Varning Vattenledning	250	100	0.10	125629
	White	Achtung TV Kabel Attention TV Cable Attenzione TV Cavo Attention TV Cable Opgelet TV Kabel Varning TV Elkabel	250	100	0.10	125627

*The imprint on the tape is written in german.

**No. 72****Repair tape**

for repairing damaged cable sheaths, self-amalgamating

Characteristics

- Self-amalgamating
- 100 % waterproof
- Superior physical and electrical properties
- Exceptional resistance to prolonged immersion in water and against ozone
- Residue-free dissolvability of most substrates and therefore suitable for temporary repairs

Application/Suitability

- Repair of damaged cable sheaths

Note

- The use of a repair joint, such as MZ cast resin straight-through joint, is mandatory in case of damage extending beyond the cable sheath to the core insulation, screen or armour.

Material

- PIB-Base

**Scope of delivery**

Repair tape

Colours

Black

Type	Colours	Length m	Width mm	Thickness mm	Art.-No.
No. 72	Black	10	25	0.75	125587
	Black	10	50	0.5	125624

Technical data	Value	Tests
min. Elongation at break	900 %	BS 903
Tensile strength	2 MPa	ASTM D150
Specific volume resistivity	$1 \times 10^{13} \Omega/\text{cm}$	ASTM D 257
Dielectric strength	42 kV/mm	ASTM D 149
Heat resistance	-40 °C - 90 °C	



KRS Repair kit

for repairing damaged cable sheaths, incl. accessories

Characteristics

- Kit content defined by the praxis

Note

- See the repair tape „No. 72“ for further information on product properties and technical data

Application/Suitability

- Repair of damaged cable sheaths

Note

- The use of a repair joint, such as MZ cast resin straight-through joint, is mandatory in case of damage extending beyond the cable sheath to the core insulation, screen or armour.



Scope of delivery

Repair tape No. 72, cleaning tissue, emery cloth, assembly instructions

Type	Art.-No.
KRS 1	145911

HB**Hot melt adhesive**

for sealing against humidity

Characteristics

- Fusible
- Supplied as tape
- Halogen-free

Application/Suitability

- Waterproof sealing for heat shrinkable products

Scope of delivery



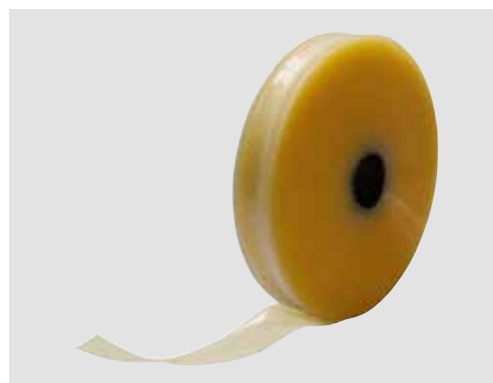

Hot melt adhesive

**Colours**

Transparent

Type	Colours	Length m	Width mm	Thickness mm	Art.-No.
HB	Transparent	50	25	0.25	130837

ACCESSORIES

	Cable ties.....	244
	Tools.....	247
	Chemical products.....	253
	Miscellaneous.....	268



KS Cable tie

Standard

Characteristics

- Smooth, rounded edges for safe and easy handling and assembly
- Internal gearing and rounded-off end to facilitate take-up, insertion and tightening
- Resistant to alkaline earth elements
- Resistant to mould and oil
- Stabilized against UV rays (colour: Black)
- Resistant to dilute acids and alkalis
- Halogen-free
- Flame retardant
- Silicone-free

Application/Suitability

- Bundling
- Affixing

Note

- Dimension tolerance $\pm 5\%$

Material

- Polyamid 6.6

Minimum holding force

- Under standard conditions correspond to 1 kg = 9.81 N

Test standards

- EN 62275

Storage conditions/Shelf life

- Ideal storage conditions are at 23 °C and 50 % relative humidity
- After opening the bag, cable ties must be used rapidly



Colours



Black

Natural

Scope of delivery

1 PU cable ties

Type		Colours	Width mm	Length mm	min. holding force N	max. bundle-Ø mm	PU pieces	Art.-No.
KS	2.5/100	Black	2.5	100	88	24	100	146408
	2.5/100	Natural	2.5	100	88	24	100	146409
	2.5/135	Black	2.5	135	88	35	100	146453
	2.5/135	Natural	2.5	135	88	35	100	146454
	2.5/200	Black	2.5	200	88	55	100	146412
	2.5/200	Natural	2.5	200	88	55	100	146414
KS	3.5/140	Black	3.5	140	176	36	100	146416
	3.5/140	Natural	3.5	140	176	36	100	146419
	3.5/200	Black	3.5	200	176	55	100	146450
	3.5/200	Natural	3.5	200	176	55	100	146452
	3.5/280	Black	3.5	280	176	80	100	146422
	3.5/280	Natural	3.5	280	176	80	100	146424
KS	4.5/200	Black	4.5	200	216	51	100	146426
	4.5/200	Natural	4.5	200	216	51	100	146428
	4.5/280	Black	4.5	280	216	76	100	146431
	4.5/280	Natural	4.5	280	216	76	100	146433
	4.5/360	Black	4.5	360	216	101	100	146434
	4.5/360	Natural	4.5	360	216	101	100	146435
KS	7.5/320	Black	7.5	320	588	88	100	146436
	7.5/320	Natural	7.5	320	588	88	100	146437
	7.5/360	Black	7.5	360	588	101	100	146438
	7.5/360	Natural	7.5	360	588	101	100	146440
	7.5/750	Black	7.5	750	588	220	100	146442
	7.5/750	Natural	7.5	750	588	220	100	146443
KS	9.0/780	Black	9.0	780	800	235	100	146448
	9.0/780	Natural	9.0	780	800	235	100	146449
KS	12.5/500	Black	12.5	500	1140	140	50	146444
	12.5/500	Natural	12.5	500	1140	140	50	146445
	12.5/1000	Black	12.5	1000	1140	300	50	146446
	12.5/1000	Natural	12.5	1000	1140	300	50	146447

Technical Data	Value
Flammability rating	UL94 V2
Mounting temperature	-5 °C up to +40 °C
Operation temperature	-40 °C up to +85 °C



KZB Fastening element

for cable ties

Characteristics

- Adhesive film to facilitate installation in hard-to-reach areas
- Resistant to water, cleaning agents and alcohol
- Conditionally resistant to aliphatic and aromatic solvents
- Self-extinguishing

Application/Suitability

- Affixing of cable ties
- Prefabrication or subsequent assembly e.g. of office equipment, lifts, motor vehicles and control cubicles

Material

- Polyamid 6.6



Scope of delivery

1 PU fastening elements

Colours



Natural

Dimensions

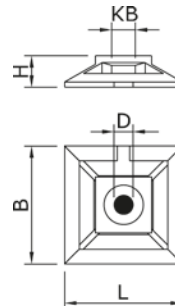

KB = max. width of the cable tie

Type		Colours	L mm	B mm	D mm	H mm	KB mm	PU pieces	Art.-No.
KZB2K	4	Natur	19	19	4,75	4,5	4	100	146484
	5	Natur	27	27	4,75	6,0	5	100	146486



CM Cable marker

for marking cables and conductors

Characteristics

- Can be labelled
- Moisture-resistant
- Oil-resistant
- Stabilized against UV rays

Application/Suitability

- Permanent marking for cables and conductors



Scope of delivery
1 PU cable markers

Type		Length mm	Thickness mm	max. Cable-Ø mm	Label area size height x width mm	PU pieces	Art.-No.
CM	10	75	0.08	13	23 x 25	60	124088
	20	150	0.08	33	23 x 25	30	124089



CPB

Heat shrink torch kit

for installation of heat shrinkable products

Characteristics

- User-friendly rotating tube connector
- Gas supply shuts off automatically if burner head is not installed
- Minimal risk of overheating
- Flame extinguishes immediately upon releasing push button
- Continuously adjustable flame
- Bayonet fitting facilitates substitution of burner head
- Quick-starting piezo ignition

Application/Suitability

- Suitable for heat shrinkable tubes
- Shrinking of heat shrinkable polyolefine products (caps, sleeves etc.)

Caution note

- Warning: Liquid gas is heavier than air. Strictly adhere to safety instructions provided with heat shrink torch kit.



Scope of delivery

Wooden case with aluminium profile with components (see order details)

Note: Individual components may also be ordered separately.

Type		Art.-No.
CPB	5 (Set)	146765
	6 (Set)	146766

Type	CPB 5 Set-components	CPB 6 Set-components	Length m	Content ml	Art.-No.
Handle CPB 5/6 with piezo ignition	•	•			146781
Needle point burner (with elbow)	•	•			146782
Heat shrink burner (with elbow)	•	•			146783
Hot-air torch (with elbow)	•	•			146784
Gas tube HD 4.4 R 3/8" li x R 3/8" li	•	•	4		146769
Anti-rupture device for tubing R 3/8" x 3/8" li	•	•			146770
Pressure controller device R 3/8" x 3/8" li	•	•			146780
Pressure controller DIN/Combo 21.8-14 LH x R 3/8 LH	•				123960
Refill connector for small gas bottle, DIN Combo		•			146786
Small gas bottle, refillable		•		400	146785

- included in scope of delivery



AMX-HPT 310 Mechanical caulking gun

suitable for cartridges up to 310 ml volume

Robust caulking gun in professional quality for usage with automatic cast resin mixing system AMX-C or standard cartridges.

Characteristics

- Sturdy cartridge holder made of sheet steel
- Hardened plunger rod
- Corrosion resistant catch plate made of high-tensile steel
- Low extrusion resistance for precise dosing

Application/Suitability

- Perfect fit for AMX-C265-EGK
- Suitable for standard cartridges
- For low and high viscosity cartridge



Scope of delivery

Caulking gun AMX-HPT 310

Type	Art.-No.
AMX-HPT 310 Caulking gun	311684



Counter-holder Assembly help

for screw connectors type CSV and screw cable lugs type CSK

The counter-holder is designed as mounting help for the installation of screw connectors and screw cable lugs with a diameter of 14 to 40 mm.

Scope of delivery

Counter-holder, reduction prism



Type	Art.-No.
Counter-holder	255404



CP-FLM20 Multi tool

for the preparation of medium voltage cables

The multi tool is designed for cutting and stripping of the outer cable sheaths and the conductor insulation, as well as for removal of cold-strippable semi-conductive layers.

Characteristics

- Suitable for cables with a diameter of 15 - 50 mm
- For cold-strippable conducting layer thickness of 0.3/0.4 mm or 0.7/0.8 mm
- Adjustable stop and limiting bar
- Cut depth of the insulation and external sheath up to 10 mm
- Suitable for PVC-/PE-/XLPE-insulation
- Adjustable feed motion

Application/Suitability

- Cutting and stripping of outer sheath
- Controlled initial cutting of cold-strippable semi-conducting layer
- Cutting and stripping of conductor insulation



Scope of delivery

CP-FLM20: Transport case, multi tool, assembly material, manual instruction

CP-FLM20-S1: Replacement blade

CP-FLM20-S2: Spare blade

Type	Art.-No.
CP-FLM20 Multi tool	250351
CP-FLM20-S1 Replacement blade (for cable sheath)	250355
CP-FLM20-S2 Spare blade (for semiconductor-layer)	250358



CP-P20 Stripping tool

for the preparation of medium voltage cables

For removal of the co-extruded outer semi-conductive layer.

Characteristics

- Minimum strip length approx. 30 mm
- Guarantees depth adjustable from 0 - 1.2 mm in 0.1 mm steps
- Maintains high quality of stripped surface
- Hard metal peeling knife
- Operating range 10 - 50 mm
- Predefined rounded corners
- Beginning of stripping at cable end
- Automatic working feed

Application/Suitability

- Cutting and stripping of co-extruded semi-conducting layer



Scope of delivery

CP-P20: Stripping tool, assembly instructions

Type	Art.-No.
CP-P20 Stripping tool	250354
Spare blade (for semiconductor-layer)	293710



CP-AFS Toolkit

for preparation of medium voltage cables with AFS

The toolkit is suitable for cutting and bending the outer sheath and tightening the stainless-steel cable ties for medium-voltage cables with the aluminium foil screen (AFS) bonded to the outer sheath: RH5Z1, NF C 33-226 (POPY, VINYL, NIKOL), ARE4H5E, ARP1H5E, XDALT

Characteristics

- Adjustable diameter: 50 mm², 95-150 mm², 240 mm², 630 mm²
- Cutting depth of the blade for AFS screen and cable sheath 1,8-4 mm

Application/Suitability

- Cutting into the outer sheath
- Folding of the outer sheath
- Tightening the stainless-steel cable tie



Scope of delivery

CP-AFS: Transport case, Cable sheath cutter, Jacket opener, Pliers, Working instructions

CP-AFS-S1: Spare blade (for Cable sheath cutter)

Type	Art.-No.
CP-AFS Toolkit	418122
CP-AFS-S1 Spare blade	418118



UNIVERSAL CLEANER 121

Cleaner

for cleaning and degreasing

Characteristics

- For use with neoprene, polyethylene, EPR, XLPE, PVC, butyl rubber and thermoplastic insulation
- Protection against accidental discharge
- Cleans and degreases without leaving residue, non-conductive
- Fast-acting, safe
- No degradation

Application/Suitability

- Cleaning of semi-conducting layers
- Removal of semi-conductive residues (such as graphite)
- Cleaning and degreasing of motors and electrical equipment
- Cleaning of cables and conductors

Note

- Clean all parts thoroughly. Air dry or wipe with a cloth. Repeat operation as required. Always test a small area prior to cleaning plastics or finished surfaces.



Colours



Clear

Scope of delivery
Cleaner

Type	Content l	Drum	Art.-No.
UNIVERSAL CLEANER 121	0.4	Spray	146404
	1	Canister	124026
	5	Canister	124027
	20	Barrel	146405

Technical Data	Value
Density	0.62 g/cm ³
Vapour pressure (at 20 °C)	200.00 hPa
Flash point	-19 °C
Ignition temperature	260 °C
Lower explosion limit in Vol.-%	1.1
Upper explosion limit in Vol.-%	13.0



ZINC SPRAY 171

Anti-corrosion spray

for subsequent galvanizing

ZINC SPRAY 171 binds to steel and iron surfaces using an electrochemical process of forming a flexible protection film. This gives the parts an active cathodic protection against corrosion.

Characteristics

- Smooth, fine porous film
- With hydrocarbon propellant (flammable)
- Can be varnished
- Can be spot-welded
- Dries quickly
- Unmarked in compliance with ARB material regulations
- No hazard rating in compliance with VBF
- Weatherproof
- Electrically conductive
- Frost-resistant

Application/Suitability

- Long-lasting corrosion protection
- Repairing of damaged zinc layers
- Repairing of galvanised surfaces
- Substitute for red lead primer
- Primer for use in auto repair
- Sealing of cavities
- Cold galvanising
- Oxidation protection
- Rust prevention
- Underbody protection



Colours



Grey

Scope of delivery

Anti-corrosion spray

Type	Content l	Drum	Art.-No.
ZINC SPRAY 171	0.4	Spray	124030

ZINC SPRAY 171 is not approved according to the the food regulations and the construction material norms release 8/76 from the Institute for Construction Technology.

Technical Data	Value
Density	0.95 g/cm ³
Degree of zinc purity	99 %



ELECTRO 2-26

Protective agent

for protection of electrical equipment

Characteristics

- Lubricates and permeates

Application/Suitability

- Corrosion protection
- Oxidation protection
- Protection against flying sparks
- Protection against leakage current
- Short-circuit protection
- Maintenance and protection of electrical equipment
- Improves drag coefficient
- Expels and provides sealing against moisture



Scope of delivery

Protective agent

Colours



Transparent

Type	Content l	Drum	Art.-No.
ELECTRO 2-26	0.4	Spray	124045
	5	Canister	124046

Technical Data	Value
Density	0.80 g/cm ³
Flash point	105 °C
Viscosity (cP)	30/40 °C
Dielectric strength	150 kV/mm



INDUSTRIE 3-36

Protective agent

for protection of metals

Characteristics

- Forms a clear, transparent film
- Lubricates and permeates

Application/Suitability

- Dissolves rust
- Release of tightly-sealed components
- Corrosion protection
- Protection of ferrous and non-ferrous metals during storage, processing, and transport
- Moisture protection



Scope of delivery

Protective agent

Colours



Transparent

Type	Content l	Drum	Art.-No.
INDUSTRIE 3-36	0.4	Spray	124014
	5	Canister	124015
	20	Barrel	124016

Technical Data	Value
Density	0.81 g/cm ³
Flash point	105 °C
Viscosity (cP)	30/40 °C
Dielectric strength	180 kV/mm



URETHAN

Protective insulating varnish

for protection against chemical exposure

Characteristics

- Highly resistant

Application/Suitability

- Corrosion protection
- Moisture protection
- Protection of appliances and materials against chemical exposure
- Protective coating for electric motors, transformers, components and appliances



Scope of delivery

Protective insulating varnish

Colours



Transparent

Type	Content	Drum	Art.-No.
URETHAN	Transparent	0.4	Spray
			124017

Technical Data	Value
Density	0.79 g/cm ³
Drying time	25-30 minutes
Flash point	-97 °C
Dielectric strength	82.9 kV/mm



CONTACT CLEANER

Cleaning spray

for cleaning of electro technical equipment

Characteristics

- Does not damage plastic, rubber or varnished surfaces
- Neutral
- Fast evaporating

Application/Suitability

- Removal of light dirt such as dust, fibres, thin oil films, moisture or residues caused by fingerprints
- Cleaning of sensitive electrical equipment



Scope of delivery

Cleaning spray

Colours



Transparent

Type	Content l	Drum	Art.-No.
CONTACT CLEANER	0.4	Spray	124024

Technical Data	Value
Density	0.64 g/cm ³
Drying time	15 minutes



PLASTIC

Clear varnish

for insulation and sealing

Characteristics

- Can be soldered through
- Does not drip
- Highly resistant

Application/Suitability

- Sealing
- Elimination or prevention of current leakage, corona discharges, soft short circuits
- Insulation of panel boards, components, wires and cables
- Protective film against pollutants such as acid, alkali, alcohol and moisture
- Sealing of board, wood, leather



Scope of delivery

Clear varnish

Colours



Transparent

Type	Content	Drum	Art.-No.
PLASTIC	0.4	Spray	124049

Technical Data	Value
Density	0.78 g/cm ³
Flash point	-97 °C
Drying time	20 minutes
Dielectric strength	21 kV/mm
Heat resistance	-70 °C up to 120 °C



SILICON

Insulating and lubricating oil spray

water repellent, prevents from flashover

Characteristics

- Does not damage rubber, plastics, textiles or varnished surfaces
- Does not damage construction materials
- Does not dry out
- Non-adherent
- Suitable for use as moisture buffer
- Water-resistant

Application/Suitability

- Elimination or prevention of current leakage, corona discharges, soft short circuits
- Wire feed lubricant
- Insulating
- Protection of high-voltage equipment and tube sockets against flying sparks
- Short-circuit protection
- Can be used as a separating agent for plastics
- Prevents treated components from sticking together



Colours



Transparent

Scope of delivery

Insulating and lubricating oil spray

Type	Content	Drum	Art.-No.
SILICON	0.4	Spray	124032

Technical Data	Value
Density	0.55 g/cm ³
Flash point	-97 °C
Viscosity (cP)	1000/20 °C
Dielectric strength	12 kV/mm
Heat resistance	-50 °C up to 200 °C



CABLE GLISS

Lubricant spray

for feeding cables and conductors

Characteristics

- Does not damage rubber, plastics, textiles or varnished surfaces
- Does not damage construction materials
- Does not dry out
- Non-adherent
- Suitable for use as moisture buffer
- Water-resistant

Application/Suitability

- Feeding of cables and wires through electrical installation conduits



Scope of delivery

Lubricant spray

Colours



Transparent

Type	Content l	Drum	Art.-No.
CABLE GLISS	0,4	Spray	124050
	0,6	Spray	458286

Technical Data	Value
Density	0.63 g/cm ³
Viscosity (cP)	1000/20 °C
Dielectric strength	12 kV/mm
Heat resistance	-50 °C up to 200 °C



EASY-GLIDE

Lubricant

for feeding cables and conductors

EASY-GLIDE simplifies and accelerates the pulling and laying of cables and wires in electric conduits and channels. Damage to cables and cable sheaths is prevented.

Characteristics

- Available in light, practical plastic bottle or in handy bucket
- Pleasant smell
- Harmless ingredients
- Biologically degradable
- Non-corrosive
- Superior lubricating properties
- Non-adherent and does not leave stains
- Does not cause skin irritation, easily washable
- Can be used with bare hands
- Non-flammable
- Silicone free

Application/Suitability

- Lubricant for feeding cables and conductors through electrical installation conduits



Scope of delivery

Lubricant

Type	Content	Drum	Art.-No.	
EASY-GLIDE	250 ml	0.25	Plastic bottle	307013
	1050 ml	1.05	Plastic bottle	219647
	5000 ml	5	Bucket	246993



DUSTER Cleaning spray

for not readily accessible areas

Characteristics

- Self-cleaning
- Newly-developed materials
- With high yield
- Chemically clean
- Evaporates immediately
- Does not corrode materials
- Develops high pressure
- Leaves no traces

Application/Suitability

- Cleaning of areas with limited accessibility
- Proven track record in photo, optic, watch, precision and electronic industries



Scope of delivery

Cleaning spray

Colours



Transparent

Type	Content l	Drum	Art.-No.
DUSTER	0.4	Spray	124051

Technical Data	Value
Density	0.55 g/cm ³



MINUS Cooling spray

for thermal fault diagnosis

Characteristics

- Cools down to -50 °C
- Does not damage construction materials
- Immediate evaporation leaving no residue
- Fast and reliable

Application/Suitability

- Thermal fault detection
- Prevention of overheating during soldering
- Cooling of heat-sensitive components
- Effective overriding of thermal switches and thermostats etc.



Scope of delivery

Cooling spray

Colours



Transparent

Type	Content l	Drum	Art.-No.
MINUS	0.4	Spray	124044

Technical Data	Value
Density	0.55 g/cm ³



MULTI Multi-function oil spray

for protection and cleaning

Characteristics

- For cleaning
- Does not damage rubber, plastics, textiles or varnished surfaces
- Dissolves rust
- Protects and lubricates
- Eliminates squeaking
- Water-repellent

Application/Suitability

- Hobbies/home/garden
- Industry and workshops
- Start-up aid for wet motors



Scope of delivery

Multi-function oil spray

Colours



Light brown

Type	Content l	Drum	Art.-No.
MULTI	0.4	Spray	124043

Technical Data	Value
Density	0.78 g/cm ³
Viscosity (cP)	30/40 °C



Silicone grease Lubricating grease

for lubrication/greasing

Characteristics

- Glides well
- Non-toxic

Application/Suitability

- Lubricant paste

Scope of delivery

Lubricating grease, Wrench, Nozzle



Colours



Transparent

Type	Content g	Art.-No.
Silicone grease	90	124055



EASY-CLEAN

Hand wipes

for universal cleaning

Most effective cleaning effect is achieved with the aid of the combination of patented liquid formula and durable, roughened cloth surface. This enables removing of heavy fat stains, tar, oil, copper paste, brake and coal dust, varnish and paints, inks, grass stains and many other stains.

Characteristics

- Heavy-duty one-step cleaning system
- Easily removes even the toughest stains
- Retains dirt without leaving traces
- Quick-drying cleaning solution with moisturising effect
- Biodegradable wipes
- Antibacterial
- Free from harmful substances
- Non-toxic
- Non-irritant
- Contains moisturising substances

Application/Suitability

- In order to remove ingrained dirt, apply the darker side of the cloth. Let it soak in, then rub off. If the stain has not come out, let it soak longer.
- Remove most of the dirt using the darker textured side of the cloth, then polish with the soft side to achieve a completely clean residue-free finish.
- Skin may feel slightly sticky after use due to moisturising emulsion, as absorption time varies according to skin types.

Storage conditions/Shelf life

- Unlimited shelf life



Scope of delivery

Hand wipes

Note: The hand cleaning wipes are packed individually in the sales display.

Type		Content pieces	Art.-No.
EASY-CLEAN	Pail 90	90	434109
	Tin 18	18	435266
	Sales display 40	40	434133

LG

Putty/sealing compound

for sealing of wall ducts

Characteristics

- Two-component PUR cast resin
- In practical and easy-to-use two-chamber bags
- Mechanically removable
- Halogen-free
- Not harmful to the environment
- Gas-tight and waterproof up to 1.5 bar
- Flexible after hardening
- Superior adhesion to metal, plastics (PVC, XLPE and PE), concrete, artificial and natural stone
- Superior thermodynamic properties

Application/Suitability

- Outdoor
- Indoor
- Underground
- Water
- Sealing of wall ducts

Storage conditions/Shelf life

- In aluminium bag 18 months at ambient temperatures between 15 °C and 35 °C

**Scope of delivery**

Putty/sealing compound, spatula, assembly instructions

Optional accessory: Cable centring aid KZ (see Accessories)
Cleaner UNIVERSAL CLEANER 121 (see Accessories)

Note: Other sizes available on request.

Type		Content ml	Art.-No.
LG	250	250	125198
	500	500	125199

Technical Data	Value
Density	1.10 g/cm ³
Hardness	80 Shore A
Reactant Flash point in open cup min.	200 °C
Cast resin component Flash point in open cup min.	200 °C
Reaction temperature	60 °C
Processing time (pot life) 250 ml mixture	
20 °C	15 minutes
35 °C	9 minutes

KZ**Cable centring aid**

for putty/sealing compound, reduces the required volume

Characteristics

- Flexible
- Individually adjustable

Application/Suitability

- Centring of cables in wall ducts

Material

- Polyethylene foam

**Scope of delivery**

Cable centring aid

Type		Length m	Thickness mm	Art.-No.
KZ	20	1	20	143490
	30	1	30	143491
	40	1	40	143492

DUCT SEAL

Universal sealing compound

based on butyl rubber

Characteristics

- Firm consistency, good shape retention, can be easily moulded
- Excellent adhesion to almost all materials (metal, concrete, stone, wood, glass, ceramic, enamel etc.)
- Plastic viscosity
- Superior ageing resistance
- High resistance to many gases
- High resistance to many condensates
- Stabilized against UV rays
- Halogen-free
- Not harmful to the environment
- High water resistance
- Easy processing

Application/Suitability

- Sealing of wall ducts, cable ducts, electrical devices, drains and sanitary installations

Storage conditions/Shelf life

- Unlimited shelf life

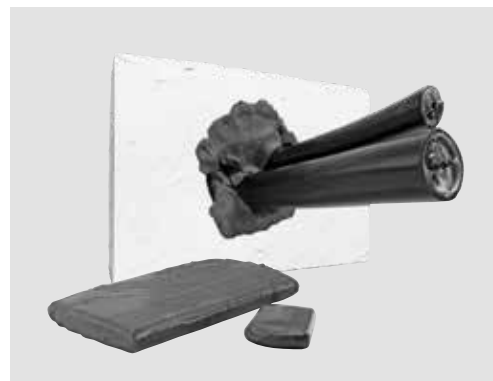

Colours



Grey

Scope of delivery

Universal sealing compound

Optional accessory: Cleaner UNIVERSAL CLEANER 121 (see Accessories)

Type		Art.-No.
DUCT SEAL	0.454 kg	240358
	2.5 kg	240357

Technical Data	Value
Short-term heat resistance	120 °C
Long-term heat resistance	
min.	-40 °C
max.	100 °C

LW..., LZW..., LWH..., LHS Splice cassette system

for fibre optic cables

Characteristics

- Flange mount strain relief for fibre optic cables
- Insertion opening for up to max. 12 glass fibres
- Flame-retardant plastic housing
- All current splice holders are interlockable (with anti-rotation protection)
- Easy attachment of stranded conductors
- Counter support bracket for easy insertion of glass fibres
- The conductors can be easily redirected to other levels
- Halogen-free
- Mechanical strain relief

Application/Suitability

- Where high performance fibre optic cabling and connections are required
- Compact joints
- Coupler housing for joints or trays
- Mechanical protection for spliced optical fibres
- Drawer application (modular compartments), choice of stress relief bushing for easy assembly of pigtail
- Vertical compartments for multi-functionality and flexibility

Note

- Recommended operating temperature range of -55 to +70 °C

Material

- Ethyl vinyl acetate insert
- Flexible heat shrinkable tube
- Stainless steel bar

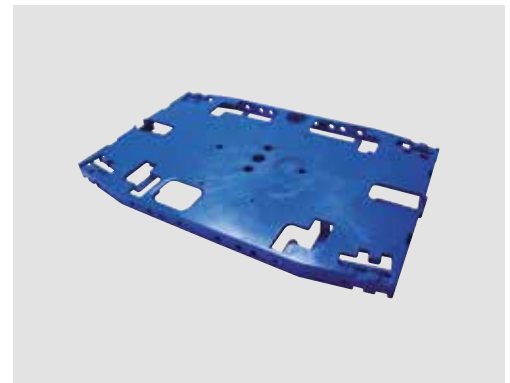

Colours



Blue



Transparent

Scope of delivery

1 PU

Type	Colours	PU pieces	Art.-No.
LWK Splice cassette	Blue	25	146694
LWD Cover	Transparent	25	126505
Strain reliefs			
LZW-L Strain relief left	Blue	25	126497
Splice holders			
LWH-S Splice holder shrink protection	Transparent	25	126506
LWH-L Splice holder 6 x shrink	Transparent	25	126499
Splice protection			
LHS Shrink splice protection	Transparent	50	146706

AZK Branch clamp

for sealing of multiple cable entry points

Characteristics

- With hot melt adhesive
- Dimensionally stable

Application/Suitability

- Sealing of multiple cable entry points in heat shrinkable repair sleeves and tubes



Scope of delivery

Branch clamp

Type	Length mm	Width mm	Art.-No.
AZK small	64	28	123982
AZK big	110	60	143744

SVL Shield continuity wire

for telecommunication cables

Characteristics

- High flexibility

Application/Suitability

- Connection and branching of aluminium-clad cable sheath
- For two or more telecommunication cables

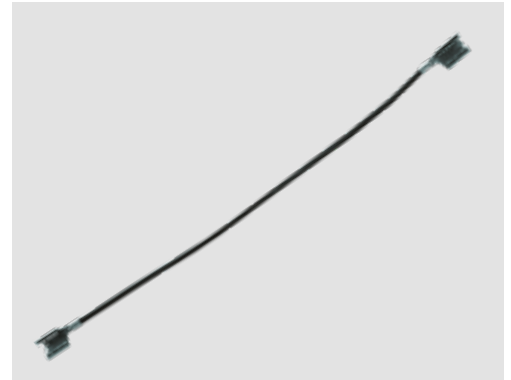

Scope of delivery

Shield continuity wire

Type	Length mm	Conductor cross-section mm ²	Art.-No.
SVL 230	230	2,5	143314
SVL 300	300	2,5	143318
SVL 350	350	2,5	143319
SVL 400	400	2,5	143320
SVL 500	500	2,5	143321

ZS-PSA (G+H+3Pb) Disposable additional set

for preparing mass-impregnated paper cables

The disposable additional set ZS-PSA (G+H+3Pb) / personal protective equipment helps installer to avoid direct contact with the hazardous substances (CMR substances) when preparing paper-insulated cable variants: Belted-, H-Type-, 3Pb (lead-sheath) cables. This kit can also be used for the preparation of the low voltage paper insulated cables as the harmful layers are identical in the preparation.

Characteristics

- Easy assembly

Application/Suitability

- For Low- and medium voltage paper insulated cables



Scope of delivery

1-piece disposable flame protective boilersuit, 1 pair disposable protective gloves with long cuff, 1-piece disposable particulate respirator with exhalation valve, 1 pair disposable overboot, and 1 piece garbage bag.

Type	Art.-No.
ZS PSA/(G+H+3Pb)	447993

INDEX

Index: of article numbers	276
Index: of article designations	281
Index: of product families	282

123...	124990..... 103	126074..... 204	126977..... 47	127113..... 52
123960..... 247	124991..... 103	126080..... 204	126990..... 47	127114..... 52
123982..... 272	124992..... 103	126082..... 204	126995..... 47	127115..... 52
		126085..... 204		127116..... 53
124...	125...	126087..... 204	127...	127117..... 53
124014..... 256	125153..... 107	126089..... 204	127000..... 47	127118..... 52
124015..... 256	125154..... 107	126091..... 204	127005..... 47	127119..... 53
124016..... 256	125155..... 107	126093..... 204	127010..... 47	127120..... 52
124017..... 257	125198..... 268	126096..... 204	127015..... 47	127121..... 52
124024..... 258	125199..... 268	126098..... 204	127020..... 50	127122..... 52
124026..... 253	125202..... 111	126099..... 204	127021..... 51	127123..... 53
124027..... 253	125203..... 111	126164..... 212	127027..... 50	127125..... 52
124030..... 254	125204..... 111	126165..... 212	127034..... 50	127126..... 53
124032..... 260	125205..... 111	126169..... 212	127041..... 50	127127..... 52
124043..... 265	125206..... 111	126170..... 212	127042..... 51	127128..... 52
124044..... 264	125207..... 111	126172..... 212	127043..... 51	127129..... 52
124045..... 255	125208..... 111	126194..... 209	127044..... 50	127130..... 53
124046..... 255	125209..... 111	126195..... 209	127045..... 50	127131..... 53
124049..... 259	125286..... 108	126196..... 209	127046..... 50	127132..... 52
124050..... 261	125287..... 108	126197..... 209	127047..... 51	127133..... 53
124051..... 263	125288..... 108	126199..... 209	127048..... 51	127134..... 52
124055..... 266	125289..... 108	126200..... 209	127049..... 50	127135..... 52
124088..... 246	125290..... 108	126202..... 209	127050..... 51	127136..... 52
124089..... 246	125291..... 108	126204..... 209	127051..... 51	127137..... 53
124169..... 76	125334..... 65	126205..... 209	127052..... 50	127139..... 52
124170..... 76	125335..... 65	126206..... 209	127053..... 50	127140..... 53
124171..... 76	125336..... 65	126207..... 209	127054..... 50	127141..... 52
124172..... 76	125337..... 65	126208..... 209	127055..... 51	127142..... 52
124173..... 76	125338..... 65	126211..... 209	127056..... 51	127143..... 52
124174..... 76	125345..... 65	126214..... 212	127057..... 50	127144..... 53
124175..... 76	125351..... 65	126216..... 213	127058..... 51	127145..... 53
124176..... 76	125365..... 66	126301..... 216	127059..... 51	127242..... 47
124293..... 74	125371..... 66	126302..... 216	127060..... 50	127383..... 58
124293..... 74	125373..... 66	126303..... 230	127061..... 50	127384..... 58
124294..... 74	125374..... 66	126313..... 230	127062..... 50	127386..... 58
124294..... 74	125533..... 231	126497..... 271	127063..... 51	127387..... 58
124295..... 74	125583..... 239	126499..... 271	127064..... 51	127391..... 58
124295..... 74	125584..... 231	126505..... 271	127065..... 50	127394..... 58
124296..... 74	125587..... 240	126506..... 271	127066..... 51	127397..... 58
124296..... 74	125589..... 231	126665..... 14	127067..... 51	127400..... 58
124297..... 74	125590..... 232	126672..... 18	127068..... 50	127403..... 58
124297..... 74	125591..... 229	126674..... 18	127069..... 50	127406..... 58
124298..... 74	125604..... 232	126675..... 18	127070..... 50	127407..... 58
124299..... 74	125624..... 240	126676..... 18	127071..... 51	127408..... 58
124300..... 74	125626..... 239	126696..... 24	127072..... 51	127416..... 58
124308..... 74	125627..... 239	126697..... 24	127073..... 50	127417..... 58
124309..... 74	125628..... 239	126698..... 24	127074..... 51	127418..... 58
124318..... 134	125629..... 239	126713..... 24	127075..... 51	127421..... 58
124319..... 134	125895..... 202	126714..... 24	127076..... 50	127423..... 58
124320..... 134	125897..... 203	126715..... 24	127077..... 50	127425..... 58
124359..... 135	125898..... 203	126716..... 24	127078..... 50	127427..... 58
124360..... 135	125899..... 203	126719..... 27	127079..... 51	127429..... 58
124361..... 135	125900..... 203	126720..... 27	127080..... 51	127431..... 58
124505..... 78	125902..... 203	126721..... 27	127081..... 50	127471..... 56
124506..... 78	125904..... 203	126740..... 27	127082..... 51	127472..... 56
124507..... 73	125905..... 203	126745..... 14	127083..... 51	127473..... 56
124508..... 73	125906..... 203	126769..... 26	127084..... 50	127474..... 56
124508..... 73	125950..... 202	126770..... 26	127085..... 50	127475..... 56
124510..... 78	125951..... 202	126771..... 26	127086..... 51	127476..... 56
124511..... 78	125952..... 202	126773..... 26	127087..... 51	127477..... 56
124513..... 78	125953..... 202	126805..... 38	127088..... 51	127488..... 61
124517..... 79	125954..... 202	126806..... 38	127089..... 50	127490..... 61
124518..... 79	125955..... 202	126807..... 38	127090..... 51	127493..... 61
124683..... 97	125956..... 202	126821..... 35	127091..... 51	127503..... 61
124685..... 98	125957..... 202	126822..... 36	127092..... 50	127507..... 61
124685..... 98	125958..... 202	126823..... 36	127093..... 50	127515..... 61
124730..... 93	125960..... 202	126824..... 36	127094..... 51	127522..... 61
124730..... 93	125966..... 203	126847..... 37	127095..... 51	127651..... 238
124763..... 93		126855..... 37	127096..... 51	127695..... 86
124763..... 93	126...	126856..... 37	127097..... 52	127695..... 86
124786..... 83	126040..... 204	126891..... 44	127098..... 53	127696..... 86
124787..... 83	126044..... 204	126899..... 44	127099..... 52	127696..... 86
124788..... 83	126046..... 204	126907..... 44	127100..... 52	127697..... 86
124789..... 83	126047..... 204	126916..... 44	127101..... 52	127697..... 86
124790..... 83	126048..... 204	126924..... 44	127102..... 52	127698..... 86
124815..... 83	126051..... 204	126932..... 44	127104..... 52	127698..... 86
124861..... 82	126052..... 204	126940..... 44	127106..... 52	127699..... 86
124901..... 103	126054..... 204	126945..... 44	127107..... 52	127699..... 86
124909..... 103	126055..... 204	126950..... 44	127108..... 52	127700..... 86
124962..... 103	126059..... 204	126954..... 44	127109..... 52	127700..... 86
124986..... 103	126060..... 204	126960..... 44	127110..... 53	127701..... 86
124989..... 103	126064..... 204	126961..... 44	127111..... 52	127701..... 86
	126070..... 204	126969..... 44	127112..... 53	127703..... 86

127703.....	86	143506.....	218	144439.....	51	145354.....	29	145908.....	231
127705.....	80	143508.....	218	144440.....	51	145359.....	13	145911.....	241
127706.....	80	143509.....	218	144444.....	51	145360.....	13	145941.....	228
127707.....	80	143556.....	66	144445.....	51	145361.....	13	145945.....	228
127708.....	80	143563.....	66	144446.....	51	145362.....	13	145948.....	228
127709.....	86	143592.....	68	144449.....	51	145363.....	13	145954.....	228
127709.....	86	143595.....	68	144450.....	51	145386.....	31	145957.....	228
127733.....	86	143601.....	68	144451.....	51	145388.....	31	145961.....	228
127733.....	86	143605.....	68	144455.....	51	145391.....	31	145967.....	228
127763.....	86	143627.....	68	144456.....	51	145396.....	32	145970.....	228
127763.....	86	143628.....	68	144457.....	51	145397.....	32	145973.....	228
		143629.....	68	144460.....	51	145398.....	32		
130...		143630.....	68	144461.....	51	145438.....	34	146...	
130837.....	242	143632.....	68	144462.....	53	145439.....	33	146016.....	228
130945.....	16	143637.....	68	144493.....	60	145443.....	34	146020.....	228
		143646.....	68	144498.....	60	145444.....	33	146024.....	228
131...		143647.....	68	144527.....	63	145448.....	34	146028.....	228
131095.....	82	143648.....	68	144536.....	63	145449.....	33	146044.....	228
131118.....	93	143649.....	68	144545.....	63	145458.....	136	146060.....	228
131118.....	93	143650.....	68	144559.....	63	145461.....	136	146064.....	228
131119.....	93	143654.....	68	144596.....	61	145464.....	136	146066.....	228
131119.....	93	143659.....	68	144613.....	61	145479.....	17	146068.....	228
131123.....	93	143661.....	68	144620.....	61	145481.....	17	146072.....	228
131123.....	93	143663.....	68	144863.....	61	145482.....	17	146107.....	228
131126.....	93	143665.....	68	144876.....	198	145483.....	17	146111.....	228
131126.....	93	143669.....	68	144878.....	198	145484.....	17	146115.....	228
131149.....	89	143670.....	68	144880.....	198	145486.....	15	146119.....	228
131149.....	89	143672.....	68	144882.....	198	145489.....	15	146123.....	64
131151.....	89	143673.....	68	144884.....	198	145493.....	15	146124.....	64
131151.....	89	143679.....	68	144886.....	198	145552.....	17	146158.....	178
131778.....	89	143680.....	68	144888.....	198	145559.....	20	146159.....	178
131778.....	89	143744.....	272	144892.....	198	145560.....	20	146160.....	178
131854.....	89	143759.....	58	144898.....	198	145561.....	21	146216.....	178
131854.....	89	143764.....	58	144921.....	198	145562.....	21	146217.....	178
131855.....	89	143766.....	58	144935.....	198	145564.....	20	146218.....	178
131855.....	89	143770.....	58	144943.....	198	145565.....	21	146220.....	181
131863.....	77	143803.....	58			145566.....	21	146222.....	181
131864.....	77	143806.....	58	145...		145568.....	20	146224.....	181
131865.....	77	143811.....	58	145064.....	56	145569.....	20	146226.....	181
131866.....	77	143818.....	58	145065.....	56	145570.....	21	146228.....	178
131867.....	77			145069.....	56	145571.....	21	146234.....	181
131999.....	35	144...		145071.....	56	145572.....	20	146235.....	181
		144013.....	58	145073.....	56	145574.....	20	146242.....	181
132...		144018.....	58	145075.....	56	145578.....	22	146296.....	181
132206.....	103	144362.....	47	145093.....	39	145600.....	40	146297.....	178
132464.....	198	144363.....	48	145096.....	39	145604.....	40	146298.....	181
		144368.....	47	145097.....	39	145611.....	40	146300.....	178
133...		144369.....	48	145102.....	42	145614.....	40	146301.....	178
133024.....	89	144371.....	47	145103.....	42	145616.....	40	146302.....	178
133024.....	89	144372.....	47	145104.....	42	145622.....	214	146303.....	181
133841.....	93	144378.....	47	145105.....	42	145624.....	214	146304.....	181
133841.....	93	144379.....	48	145106.....	42	145630.....	132	146306.....	181
		144381.....	47	145107.....	42	145631.....	132	146309.....	179
		144382.....	47	145108.....	42	145633.....	132	146310.....	179
134...		144385.....	47	145111.....	42	145635.....	132	146404.....	253
134999.....	103	144386.....	48	145115.....	42	145653.....	19	146405.....	253
		144388.....	47	145116.....	42	145655.....	19	146408.....	244
135...		144389.....	47	145118.....	42	145656.....	19	146409.....	244
135533.....	108	144392.....	47	145119.....	42	145657.....	19	146412.....	244
135534.....	107	144393.....	48	145120.....	42	145659.....	19	146414.....	244
135859.....	58	144395.....	47	145121.....	42	145660.....	19	146416.....	244
135860.....	61	144396.....	47	145122.....	42	145661.....	19	146419.....	244
		144399.....	47	145123.....	42	145665.....	19	146422.....	244
		144400.....	48	145124.....	42	145666.....	19	146424.....	244
137...		144401.....	47	145125.....	42	145667.....	19	146426.....	244
137358.....	110	144402.....	47	145126.....	42	145668.....	19	146428.....	244
137406.....	110	144406.....	47	145127.....	42	145669.....	19	146431.....	244
137877.....	110	144407.....	48	145128.....	42	145670.....	19	146433.....	244
		144408.....	47	145129.....	42	145671.....	19	146434.....	244
139...		144409.....	47	145130.....	42	145680.....	19	146435.....	244
139163.....	110	144412.....	48	145131.....	42	145681.....	19	146436.....	244
		144413.....	47	145243.....	16	145682.....	19	146437.....	244
143...		144414.....	48	145246.....	14	145771.....	226	146438.....	244
143314.....	273	144415.....	47	145249.....	14	145772.....	226	146440.....	244
143318.....	273	144416.....	47	145255.....	14	145773.....	226	146442.....	244
143319.....	273	144420.....	54	145257.....	14	145784.....	226	146443.....	244
143320.....	273	144426.....	51	145282.....	14	145794.....	226	146444.....	244
143321.....	273	144429.....	51	145295.....	14	145806.....	225	146445.....	244
143490.....	269	144430.....	51	145296.....	14	145821.....	225	146446.....	244
143491.....	269	144431.....	51	145320.....	14	145862.....	239	146447.....	244
143492.....	269	144433.....	51	145332.....	14	145864.....	239	146448.....	244
143502.....	218	144434.....	51	145338.....	14	145865.....	239	146449.....	244
143503.....	218	144438.....	51	145342.....	14	145867.....	239	146450.....	244
143505.....	218								

146452.....	244	169...		194069.....	155	197659.....	193	204312.....	53
146453.....	244	169406.....	76	194070.....	155	197660.....	193	204313.....	53
146454.....	244	169459.....	179	194071.....	155	197690.....	221	204984.....	230
146484.....	245	169471.....	66	194072.....	144	197692.....	221		
146486.....	245	169473.....	66	194073.....	144	197699.....	221	205...	
146694.....	271	169475.....	66	194074.....	144	197701.....	221	205102.....	17
146706.....	271	169477.....	66	194075.....	144	197702.....	221		
146765.....	247	169711.....	66	194076.....	144			207...	
146766.....	247			194077.....	144	199...		207247.....	230
146769.....	247	171...		194078.....	144	199151.....	157		
146770.....	247	171756.....	181	194079.....	144	199152.....	157	219...	
146780.....	247	171757.....	181	194080.....	144	199154.....	157	219647.....	262
146781.....	247	171761.....	178	194082.....	144	199155.....	157		
146782.....	247	171762.....	178	194083.....	144	199162.....	157	222...	
146783.....	247	171763.....	178	194085.....	144	199163.....	157	222242.....	66
146784.....	247			194086.....	145	199164.....	157		
146785.....	247	174...		194087.....	145	199165.....	157	223...	
146786.....	247	174183.....	16	194088.....	145	199166.....	157	223131.....	66
		180...		194089.....	145	199167.....	157	223132.....	66
147...		180739.....	24	194090.....	145	199168.....	157	223574.....	237
147533.....	93	180760.....	24	194091.....	145	199184.....	159	223575.....	237
		180761.....	26	194092.....	145	199185.....	159	223576.....	236
148...				194093.....	145	199186.....	159	223577.....	236
148152.....	137	182...		194094.....	145	199187.....	159	223578.....	236
148153.....	137	182390.....	137	194293.....	176	199194.....	159	223580.....	235
148840.....	56			194294.....	176	199195.....	159	223581.....	235
148842.....	56	186...		194295.....	176	199196.....	159	223583.....	234
148844.....	66	186615.....	66	194296.....	176	199197.....	159	223585.....	234
148876.....	110			194297.....	176	199198.....	159	223590.....	233
		193...		194298.....	176	199199.....	159	223591.....	233
149...		193339.....	145	194299.....	176			223592.....	233
149433.....	56	193370.....	145	194300.....	176	200...			
		193372.....	155	194301.....	176	200294.....	53	225...	
150...		193374.....	155	194302.....	176	200295.....	53	225844.....	169
150148.....	56	193414.....	152	194303.....	176			237...	
150149.....	56	193416.....	152	194304.....	176	201...		237858.....	196
150158.....	14	193442.....	55	194305.....	176	201386.....	146	237859.....	196
150160.....	14	193644.....	208	194306.....	176	201395.....	146	237860.....	196
150161.....	14	193872.....	39	194307.....	176	201942.....	196	237861.....	196
150162.....	14			194932.....	205	201943.....	196	237862.....	196
150278.....	56	194...		194933.....	205	201944.....	196		
150826.....	29	194017.....	152	194934.....	205	201945.....	196		
		194018.....	152	194935.....	205	201946.....	196	240...	
152...		194019.....	152	194936.....	205			240160.....	56
152008.....	56	194030.....	152	194939.....	205	203...		240163.....	56
152521.....	18	194031.....	152	194941.....	205	203028.....	18	240167.....	56
152522.....	18	194032.....	152	194942.....	205	203029.....	18	240168.....	56
152932.....	93	194033.....	152			203040.....	18	240170.....	56
152932.....	93	194034.....	152	195...		203041.....	18	240357.....	270
		194035.....	152	195365.....	178	203674.....	53	240358.....	270
154...		194036.....	152	195366.....	181	203675.....	53		
154982.....	39	194037.....	152	195367.....	220	203676.....	53	246...	
		194038.....	152	195368.....	220	203677.....	53	246176.....	162
155...		194039.....	152	195816.....	84	203678.....	53	246993.....	262
155962.....	56	194040.....	152			203679.....	53		
		194041.....	152	197...		203680.....	53	247...	
157...		194042.....	152	197603.....	186	203787.....	53	247102.....	162
157645.....	93	194043.....	152	197604.....	186	203788.....	53		
157645.....	93	194044.....	152	197606.....	186	203789.....	53	248...	
		194045.....	152	197608.....	189	203790.....	53	248494.....	112
158...		194046.....	152	197609.....	189	203791.....	53		
158903.....	61	194047.....	152	197610.....	189	203792.....	53	249...	
		194048.....	152	197614.....	189			249007.....	112
163...		194049.....	155	197616.....	189	204...			
163952.....	17	194050.....	155	197617.....	189	204011.....	48	250...	
		194051.....	155	197618.....	187	204013.....	48	250181.....	112
165...		194052.....	155	197619.....	187	204015.....	48	250351.....	250
165612.....	39	194053.....	155	197620.....	187	204017.....	48	250354.....	251
165912.....	68	194054.....	155	197631.....	191	204018.....	48	250355.....	250
		194055.....	155	197632.....	191	204020.....	48	250358.....	250
166...		194056.....	155	197633.....	191	204022.....	48	250720.....	162
166012.....	68	194057.....	155	197634.....	191	204024.....	48	250726.....	162
166013.....	68	194058.....	155	197635.....	191	204026.....	48		
166016.....	68	194059.....	155	197636.....	191	204028.....	48	254...	
166374.....	203	194061.....	155	197637.....	191	204029.....	48	254684.....	28
166972.....	66	194062.....	155	197641.....	192	204032.....	48		
166973.....	66	194063.....	155	197642.....	192	204034.....	48	255...	
		194064.....	155	197643.....	192	204035.....	48	255404.....	249
167...		194065.....	155	197644.....	192	204297.....	53	255406.....	206
167690.....	179	194066.....	155	197645.....	192	204298.....	53	255408.....	206
		194067.....	155	197646.....	192	204299.....	53		
		194068.....	155	197647.....	192	204310.....	53	256...	
				197658.....	193	204311.....	53	256838.....	165

416782.....	227	456...		457330.....	45
416783.....	227	456087.....	149	457331.....	45
416784.....	227	456088.....	149	457332.....	45
416785.....	227	456089.....	149	457333.....	45
416786.....	227	456150.....	149	457334.....	45
416787.....	227	456151.....	149	457336.....	45
416788.....	227	456153.....	149	457337.....	45
416789.....	227	456154.....	149	457338.....	45
		456155.....	149	457339.....	45
418...		456156.....	149	457340.....	45
418118.....	252	456330.....	215	457341.....	46
418122.....	252	456331.....	215	457342.....	46
		456332.....	215	457343.....	46
420...		456333.....	215	457344.....	46
420083.....	102	456334.....	215	457345.....	46
420576.....	217	456335.....	215	457346.....	46
420577.....	217	456336.....	215	457347.....	46
420578.....	217	456337.....	215	457348.....	46
420646.....	217	456338.....	222	457349.....	46
420647.....	217	456339.....	222	457350.....	46
		456340.....	222	457351.....	46
421...		456341.....	222	457353.....	46
421451.....	143	456342.....	222	457356.....	46
421453.....	143	456343.....	222	457357.....	46
421454.....	143	456344.....	222	457358.....	46
		456345.....	222	457359.....	46
				457360.....	46
425...		457...		457361.....	46
425469.....	100	457265.....	44	457362.....	46
425490.....	100	457266.....	44	457363.....	46
425491.....	100	457267.....	44	457364.....	45
425589.....	101	457268.....	44	457365.....	45
		457269.....	44	457366.....	45
428...		457280.....	44	457367.....	45
428123.....	101	457281.....	44	457368.....	45
428124.....	101	457282.....	44	457369.....	45
		457283.....	44	457370.....	45
434...		457284.....	44	457371.....	45
434109.....	267	457285.....	44	457372.....	46
434133.....	267	457286.....	44	457373.....	46
434565.....	106	457287.....	44	457374.....	46
434566.....	106	457288.....	44	457375.....	46
		457289.....	44	457376.....	46
435...		457290.....	44	457377.....	46
435266.....	267	457291.....	45	457378.....	46
		457292.....	45	457379.....	46
436...		457293.....	45	457772.....	116
436820.....	91	457294.....	45	457773.....	116
436821.....	91	457295.....	45	457774.....	116
436822.....	91	457296.....	45		
436823.....	96	457297.....	45	458...	
436824.....	96	457298.....	45	458286.....	261
436825.....	96	457299.....	45		
		457300.....	45	461...	
443...		457301.....	45	461182.....	219
443213.....	149	457302.....	45	461183.....	219
443960.....	61	457303.....	45	461184.....	219
443980.....	61	457304.....	45	461305.....	123
		457305.....	45	461306.....	123
444...		457306.....	45	461307.....	123
444005.....	61	457307.....	45		
		457308.....	45	469...	
446...		457309.....	45	469008.....	239
446312.....	210	457310.....	45		
446313.....	210	457311.....	45	472...	
446314.....	210	457312.....	45	472575.....	118
446315.....	210	457313.....	45		
		457314.....	45	479...	
447...		457315.....	45	479476.....	165
447993.....	274	457316.....	45		
		457317.....	45		
449...		457318.....	45		
449749.....	116	457319.....	45		
449750.....	116	457320.....	45		
449751.....	116	457321.....	45		
		457322.....	45		
450...		457323.....	45		
450152.....	170	457324.....	45		
		457325.....	45		
451...		457326.....	45		
451511.....	114	457327.....	45		
451512.....	114	457328.....	45		
451513.....	114	457329.....	45		

A	CWS 250A	160	M...MS6 EG	134	SMH...G	17
AK	CWS 400A	162	M...MS6 UG	135	SMH...V	13
AMX-C			M...V-Euroline	77	SMH3...MS6	132
AMX-HPT 310			M1, T1 und Y1	99	SMH4...Pb-RF	29
AUF	D		MBS1	54	SMHA4	16
AVS	D1	98	M-Euroline	76	SMHC	18
AZK	DK-AL-LD	205	MINUS	264	SMHF	20
	DK-CU-V	204	MMK	55	SMHSV	12
	DR, DR-L	215	MR 0	73	SMHSV3-1...MS6	133
	DUCT SEAL	270	MSFA	22	SMHSV4...Pb-RF	30
	DUSTER	263	MULTI	265	SMSV	25
	DV-CU-V	202	MZ	78	SOFT GEL	128
	DVZ-CU-V-LD	203	MZ...FG	79	SR1F	44
					SR1F3	47
C	E		N		SR1F3	49
CABLE GLISS	EASYCELL®	121	No. 128	225	SR2, SRH2	58
CAE-F	EASYCELL® COMPACT	118	No. 26	239	SR2LK, SR2LK-PEN	39
CAE-I	EASYCELL® EASY...	120	No. 328	227	SR3, SRH3	61
CAESK-F	EASYCELL® EASY...V	119	No. 60, No. 62	231	SRAT	198
CAESK-I	EASYCELL® EASY...V	122	No. 61	232	SRBB	196
CAM-S	EASY-CLEAN	267	No. 63	230	SRBK-Set	64
CAMSV-C	EASY-FIX	28	No. 64	229	SRC1	42
CAMSV-S	EASY-GLIDE	262	No. 72	240	SRC1	43
CCMSV	EASY-PROTECT	114	No. 90	228	SRFH2	60
CG	EASY-PROTECT Gelbox	115			SRFH3	63
CGS 250A	EASY-PROTECT INLINE	116	P		SRMAHV	68
CHE-3F(A)	EASY-PROTECT INLINE Gelbox117		P...EG	85	SRMAHV	68
CHE-3I(A)	EG	103	P...EG	86	SRUM	56
CHE-3I-T	EGA	217	P...GG	87	SUPRA GEL	127
CHE-F	EGA	218	Padding kit	221	SVL	273
CHE-I	EGA-CCMSV-AFS	219	PLASTIC	259		
CHEK-3F(A)	ELECTRO 2-26	255	POWER GEL	124	T	
CHEK-3I(A)	EXPRESS+ GEL	123	Premio 1130	234	T...EG	89
CHEK-F			Premio 1180	235	T...GG	90
CHEK-I	F		Premio 2281	236	T...V FKM	91
CHM	FG	107	Premio 5584	237	Tool counter holder	249
CHM	FK	211	Premio 845	233		
CHM...V	G		PV...EG, PVM...EG,		U	
CHM...V	GG	105	PVS...EG	80	UG	108
CHM3			PVC insulation tape	227	Universal Box CG	102
CHMP(3Pb)3	H		PVS...GG	81	Universal Box CG WAGO ..	101
CHMP(3Pb)3-1	H	83			UNIVERSAL CLEANER 121 ..	253
CHMP(3Pb)SV3-1	H 5-SYS	84	R		URETHAN	257
CHMP(3Pb)SV3-1	HB	242	RF	222	UWR	110
CHMP(H)3-1	HE 1/70/150	208				
CHMP(H)SV3-1	HKB	238	S		V	
CHMPPR3			SB	50	V, VI, VS	212
CHMPR3	I		SB	52	VASMI	21
CHMPR3-1	INDUSTRIE 3-36	256	SEEV	136		
CHMPRSV3-1			SEEV-F	137	W	
CHMSV	J		SEH	66	WG	111
CHMSV3	JUMBO GEL	125	SEH4...A+Z	38		
CHMSV3-1			SEH4...S-C	37	Y	
CHRMSV	K		SEH4...V-C	36	Y...EG	92
CIK	KAV	82	SEH4...V-S	35	Y...GG	94
CKS 1250A	KP	213	SEMH...-K	31	Y...V FKM	96
CL	KRS	241	SEMHK4...Pb	32	YCP	97
CLEAR GEL	KS	244	SFEH	34		
CM	KZ	269	SFEX	33	Z	
Compact ring clamp	KZB	245	SHE	40	ZINC SPRAY 171	254
CONTACT CLEANER			SILICON	260	ZS	167
CP-AFS	L		Silicone grease	266	ZS-PPb	26
CPAS	LG	268	SKH	65	ZS-PSA (G+H+3Pb)	274
CPB	LW... , LZW... , LWH... , LHS ..	271	SM, SM-MA	23		
CPES			SMDH	27		
CP-FLM20	M		SMH	14		
CP-P20	M...EG	74	SMH	15		
CPS	M...GG	75	SMH...E90, SMHC...E90 ..	19		
CSK						
CSV-T						
CTKS 630A						
CTKSA						
CTS 1250A						
CTS 630A						
CVS 250A						

1	
1-core indoor cable termination	
• for all 1-core polymeric cables	152,155,157,159
• with screw cable lugs, for all 1-core polymeric cables	150,153,156,158
1-core repair straight-through joint	141
1-core straight-through joint	
• All-in-one coldshrink joint with screw connector	149
• for all 1-core polymeric cables	144
• with screw connector and cold shrinkable outer protection, for all 1-core polymeric cables	147
• with screw connector and heat shrinkable outer protection, for all 1-core polymeric cables	148
• with screw connector, for all 1-core polymeric cables	140,142,143
3	
3-core indoor cable termination	
• for 3-core polymeric flexible cables	179
• for all 3-core polymeric cables	178
• for armoured 3-core polymeric cables without semi-conductive layer up to 7.2 kV	136
• with screw cable lugs, for all 3-core polymeric cables	177
3-core outdoor cable termination	
• for all 3-core polymeric cables	181
• for armoured 3-core polymeric cables without semi-conductive layer up to 7.2 kV	137
• with screw cable lugs, for all 3-core polymeric cables	180
3-core straight-through joint	
• for all 3-core polymeric cables	176
• with screw connectors, for all 3-core polymeric cables	174
A	
Accessory kit	
• for mass-impregnated paper cables for heat shrinkable universal straight-through joints SM and SM-MA	26
• for separable connectors	167
Anti-corrosion spray	254
Armour transition for 3-core joints	220
Assembly help	249
Assembly kit	22
Assortment box	54
Automatic cast resin mixing system	112
B	
Branch clamp	
• for cast resin branch joints, for low voltage	213
• for low voltage	208
• for sealing of multiple cable entry points	272
C	
Cable centring aid	269
Cable marker	246
Cable repair kit	28
Cable tie	244
Cast resin branch / straight-through joint	98
Cast resin branch joint for house connections	84
Cast resin branch joint	
• for polymeric cables and conductors	82,89,90,92,94,97
• with integrated strain relief, for polymeric cables and mass-impregnated paper cables, with cast resin EG	85
• with integrated strain relief, for polymeric cables and mass-impregnated paper cables, with cast resin GG	87
• with split bolt branch clamps, for polymeric cables and conductors	91,96
Cast resin straight-through and branch joints	99
Cast resin straight-through joint	
• drummable, with flexibel cast resin, for unarmoured polymeric cables and conductors	79
• for control cables and signal cables	78
• for polymeric cables and conductors	76
• for polymeric cables and conductors, control cables and signal cables	74
• particularly for small cross sections, for polymeric cables and conductors, control cables and signal cables	73
• with integrated strain relief, for polymeric cables and conductors, with cast resin EG	80
• with integrated strain relief, for polymeric cables and conductors, with cast resin GG	81
• with screw connectors, for polymeric cables and conductors	77
Cleaner	253
Cleaning spray	
• for cleaning of electro technical equipment	258
• for not readily accessible areas	263
Clear varnish	259
Compression cable lug Al	205
Compression cable lug Cu	204
Compression connector Cu	
• according to DIN 46267, with separator, for low voltage	203
• according to DIN 46267, without separator, for low voltage	202
Conductive tape	232
Connecting element up to 24 kV	169
Connection and branch box	
• OBO cable junction box with WAGO COMPACT Type 221 splicing connectors	101
• with clamps and non-labelled cast resin	102
Cooling spray	264
Copper braid tape	230
Copper foil	236
Cotton cloth tape	228
Coupling element up to 36 kV	170
Coupling surge arrester	166
D	
Disposable additional set	274
E	
Earthing clamp	216
Earthing kit	219
Earthing set for Cable Joints type CHMSV3 & CHMSV3-1	217
Earthing set for cable terminations	218
Elbow separable connector	
• for all 1-core polymeric cables, for outer cone system terminals type A	160
• for all 1-core polymeric cables, for outer cone system terminals type B	162
End-plugs	171
F	
Fastening element	245
Fibreglass tape 130 °C	234
Fibreglass tape 180 °C	235
G	
Gel box	
• with connection block	118,119

• with WAGO COMPACT Splicing Connectors	114	• thin wall, self-extinguishing, shrink ratio 3 : 1, without adhesive	52
• with WAGO COMPACT-Inline Splicing connectors with lever	116	Heat shrinkable tube kit	39
Gel branch joint	122	Heat shrinkable universal straight-through joint • with screw connectors (with shear head bolts), for polymeric cables with concentric conductor	25
Gel straight-through joint • with connection block	119	• for polymeric cables, conductors and mass-impregnated paper cables	23
• without connection block	120	Heat shrinkable wall duct	40
H		High voltage insulation tape	231
Hand wipes	267	Hot melt adhesive	242
Heat shrink torch kit	247	I	
Heat shrinkable cable termination • for unarmoured polymeric cables	34	Insulating and lubricating oil spray	260
• for unarmoured polymeric cables and conductors	33	K	
Heat shrinkable crimp connector	215	Kit for reducing the cross-section of joints	221
Heat shrinkable end cap	65	L	
Heat shrinkable indoor and outdoor cable termination	38	Lubricant	262
Heat shrinkable indoor cable termination • for armoured polymeric cables	35	Lubricant spray	261
• for polymeric cables with concentric conductor	36,37	Lubricating grease	266
Heat shrinkable medium wall tube • halogen-free, shrink ratio 3 : 1, with or without adhesive	58	M	
• protection for busbar systems and reduction of minimum clearance, halogen-free, shrink ratio 3 : 1	196	Mastic tape	238
• self-extinguishing, flexible, shrink ratio 3 : 1 or 4 : 1, with adhesive	56	Mechanical caulking gun	248
• self-extinguishing, shrink ratio 3 : 1, with adhesive	60	Mini joint case	55
Heat shrinkable repair sleeve	68	Multi tool	250
Heat shrinkable spreader cap	66	Multi-function oil spray	265
Heat shrinkable straight-through joint • for armoured polymeric cables	27	O	
• for cable systems E90 according to DIN standard 4102 Section 12	19	One-component gel based on silicon	128
• for flexible cables	17	P	
• for polymeric cables with concentric conductor	18	Pressure spring	222
• for tape and wire armoured polymeric cables	16	Protective agent • for protection of electrical equipment	255
• for telecommunication cables	20	• for protection of metals	256
• for unarmoured polymeric cables and conductors	14	Protective insulating varnish	257
• with heat shrinkable crimp connectors, for control cables and signal cables	15	Putty/sealing compound	268
• with screw connectors (with shear head bolts), for unarmoured polymeric cables and conductors	12	PVC insulation tape • for insulation and bundling	227
• with screw connectors, for unarmoured polymeric cables and conductors	13	• for marking, bundling and insulating	225
• with temperature colour indicator, for telecommunication cables	21	R	
Heat shrinkable thick wall tube • anti-slip, halogen-free, shrink ratio 3:1, with adhesive	64	Repair kit	241
• halogen-free, shrink ratio 3 : 1	198	Repair tape	240
• halogen-free, shrink ratio 3 : 1, with or without adhesive	61	S	
• self-extinguishing, shrink ratio 3 : 1, with adhesive	63	Screw branch clamp Al-Cu	210
Heat shrinkable thin wall tube • halogen-free, shrink ratio 2 : 1, without adhesive	42	Screw cable lug for Cu and Al	207
• self-extinguishing, shrink ratio 2 : 1, without adhesive	44	Screw connector Al-Cu	212
• self-extinguishing, shrink ratio 3 : 1, without adhesive	47	Screw connector for Cu and Al	206
Heat shrinkable transition joint • with screw connectors, with solderless earthing wire connection, for polymeric cables and mass-impregnated paper cables	30	Sealing tape	229
• with solderless earthing wire connection, for polymeric cables and mass-impregnated paper cables	29	Self-adhesive foam tape	237
Heat shrinkable tube in dispenser box • thin wall, self-extinguishing, shrink ratio 2 : 1, without adhesive	50	Shield continuity wire	273
		Splice cassette system	271
		Split bolt clamp	211
		Straight-through joint • for belted cables/H-Type cables up to 17.5 kV (MIND)	193
		• with screw connectors, for connecting from 3-core with three 1-core polymeric cables	175

• with screw connectors, for connecting from 3-core with three 1-core polymeric cables up to 7.2 kV	133
Strain relief	121
Stripping tool	251
T	
Tape for cable bundle	233
Test and earthing kit	172
Test kit	173
Toolkit	252
Transition joint	
• for 3 lead sheath cables to 3-core polymeric cables	192
• for 3 lead sheath cables to three 1-core polymeric cables	191
• from belted cables/H-Type cables to 3-core polymeric cables	187
• from belted cables/H-Type cables to three 1-core polymeric cables	186
• from H-Type cables to polymeric three 1-core cables	189
• with screw connectors, for 3 lead sheath cables to three 1-core polymeric cables	190
• with screw connectors, from belted cables/H-Type cables to 1-core polymeric cables	185
• with screw connectors, from H-Type cables to polymeric three 1-core cables	188
T-shaped separable connector	163
T-shaped separable coupling connector	165
Two-component gel based on silicon	
• cost-effective casting for big quantities	125
• Only 15 seconds of mixing time for extremely fast casting	123
• ready-to-use, delivered with static mixer for small volume boxes	127
• to cast branch and connection boxes	124
• to protect electrical components and LEDs	126
Two-component hydrocarbon resin	106
Two-component PUR cast resin	
• flame retardant	108
• flexible	107
• low reactivity to water	110
• reduced hazard-class	105
• removable	111
• universal	103
U	
Universal sealing compound	270
V	
Voltage-resistant insulating cap	168
Voltage-resistant pot end joint	
• with inner cap, for mass-impregnated paper cables	32
• with inner caps and outer cap, for polymeric cables and conductors	31
W	
Warning tape	239
Wire connector	214



Europe

BBC Cellpack AG

Wiesengasse 20
8222 Beringen
Switzerland

☎ +41 56 618 12 34

✉ verkauf.epschweiz@cellpack.com

BBC Cellpack GmbH

Carl-Zeiss-Straße 20
79761 Waldshut-Tiengen
Germany

☎ +49 7741 6007-0

✉ electrical.products@cellpack.com

BBC Cellpack GmbH

Carl-Eschebach-Straße 11
01454 Radeberg
Germany

☎ +49 3528 41983 0

✉ electrical.products@cellpack.com

Behr Bircher Cellpack BBC Benelux B.V.

Keersluisweg 13
1332 EE Almere Buiten
Netherlands

☎ +31 36 549 03 36

✉ info.nl@cellpack.com

Behr Bircher Cellpack BBC Polska Sp. z o.o.

ul. Matuszewska 14,
03-876 Warszawa
Poland

☎ +48 22 853 53 54

☎ +48 22 853 53 56

✉ EPPoland@cellpack.com

Behr Bircher Cellpack BBC Italia S.r.l.

Via Mantero, 20
22070 Grandate (CO)
Italy

☎ +39 031 426 611

✉ epitalia@cellpack.com

Behr Bircher Cellpack Ibérica, S.A.

C/.Mas Pujol, nr. 47 – Nave 4
Pol. Ind. Sector V
08520 – Les Franqueses del Vallès
Barcelona - Spain

☎ +34 93 846 63 76

☎ +34 93 849 12 06

✉ epiberica@cellpack.com

Behr Bircher Cellpack BBC France s.à.r.l.

Tour Part-dieu
129 rue Servient
69003 Lyon
France

☎ +33 420 930 000

✉ epfrance@cellpack.com

Middle East

Behr Bircher Cellpack BBC Middle East FZE

Jafza One Tower B, Office 1018
P.O. Box 61143
Jebel Ali Free Zone
Dubai, United Arab Emirates

☎ +971 4 5879001

✉ EPSalesME@cellpack.com

Asia-Pacific

Behr Bircher Cellpack BBC Far East Pte Ltd

31 Kaki Bukit Road 3
#06-15 Techlink
Singapore 417818

☎ +65 6747 7024

☎ +65 6841 4554

✉ epsales.apac@cellpack.com

Behr Bircher Cellpack BBC Malaysia Sdn. Bhd.

No 17, Jalan Laman Setia 7/3
Setia Business Park
81550 Gelang Patah
Johor – Malaysia

☎ +60 7 559 0570

☎ +60 7 559 0571

✉ epsales.apac@cellpack.com

FOLLOW US ON
SOCIAL MEDIA



WE CONNECT YOUR ENERGY